

Annual Report 2020-21

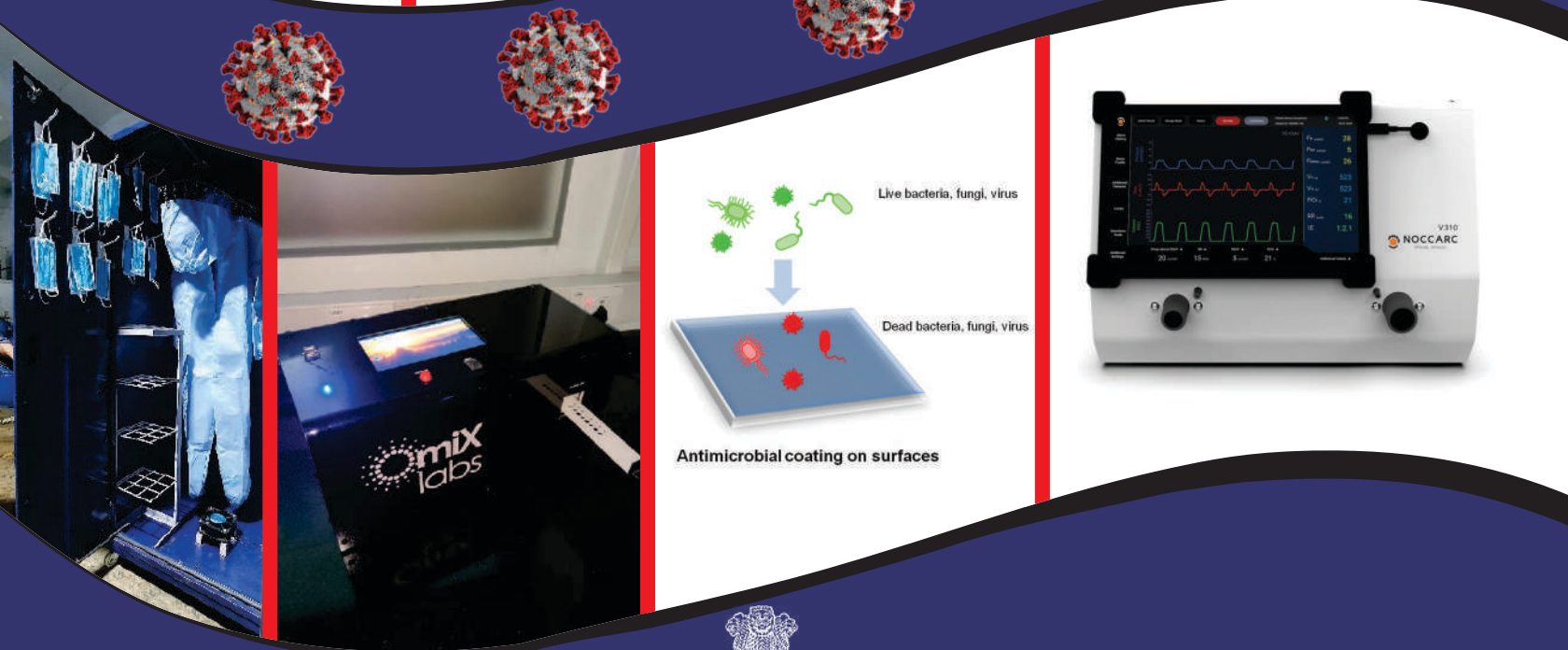

Government of India
Department of Science & Technology
Ministry of Science & Technology
New Delhi

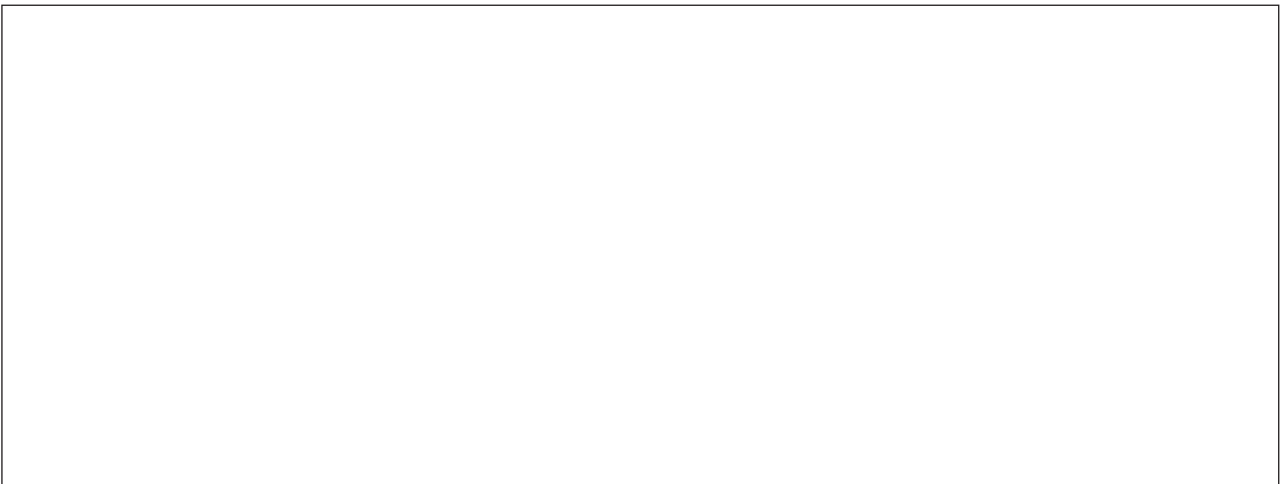

'Department of Science & Technology and its various Autonomous Institutions made some sincere efforts and contributed immensely to address R&D and innovation related challenges arising out of COVID-19 pandemic. The products depicted here represent some of the significant outcomes in the areas of Diagnostic, Testing, low-cost ventilators, protective gears, effective sterilization, etc.'

Annual Report 2020-21



Government of India
Department of Science & Technology
Ministry of Science & Technology
New Delhi

CONTENTS

Overview		v
1.	S & T INSTITUTIONAL & HUMAN CAPACITY	1
1.1	R&D Support (FIST, PURSE, SAIF)	1
1.2	State Science & Technology Programme	8
1.3	Policy Research Cell	16
1.4	Centre for Human and Organizational Research Development (CHORD)	21
1.5	Training of Scientists and Technologists Working in Government Sector	26
1.6	KIRAN	27
1.7	INSPIRE	33
1.8	INSPIRE AWARDS - MANAK	36
1.9	Swarna Jayanti Fellowship	39
2	RESEARCH & DEVELOPMENT	42
2.1	International Cooperation Division (ICD)	42
2.2	National Mission on Nano Science & Nano Technology	67
2.3	Mega Facility for Basic Research	92
2.4	Climate Change Programme (NMSHE & NMSKCC)	103
2.5	National Supercomputing Mission	115
2.6	Technology Fusion & Applications Research (TFAR) Programme	120
3	INNOVATION TECHNOLOGY DEVELOPMENT AND DEPLOYMENT	133
3.1	Technology Development Programme (TDP)	133
3.2	Technology Missions Division (CERI & WTI)	143
3.3	National Geospatial Programme (NGP)	155
3.4	National Science & Technology Entrepreneurship Development Board (NSTEDB)	166

3.5	National Council for Science and Technology Communication	181
3.6	Science for Equity for Empowerment and Development (SEED) Division	190
3.7	Special Component Plan For Scheduled Castes (SCSP) & Tribal Areas Sub Plan (TSP)	206
3.8	Drug and Pharmaceutical Research	212
3.9	Good Laboratory Practice (GLP)	213
3.10	Patent Facilitation Programme (PFP)	214
3.11	Technical Research Centre	217
3.12	Exhibitions and Fairs	225
3.13	National Spatial Data Infrastructure (NSDI)	226
4	NATIONAL MISSION ON INTERDISCIPLINARY CYBER PHYSICAL SYSTEMS (NM-ICPS)	233
4.1	Mission Technologies	233
4.2	Mission Implementation Strategy	233
4.3	Mission Implementation Model	233
4.4	Current Status and progress	235
4.5	Mission under consideration	236
5	AUTONOMOUS INSTITUTES	237
6	SCIENCE AND ENGINEERING RESEARCH BOARD (SERB)	287
7	TECHNOLOGY DEVELOPMENT BOARD	300
8	STRENGTHENING SURVEY AND MAPPING ACTIVITY	306
9	ADMINISTRATION	329
10	AUDIT OBSERVATION	335
11	BUDGET	337
	ABBREVIATION	338

OVERVIEW

Department of Science & Technology as the nodal agency promoting new areas of Science & Technology in the country connects science and technology sector to different Government horizontals and verticals, academia, R&D and industry. DST provides the largest extramural research and development support in the country to strengthen national S&T capacity and capability through a competitive mode to scientists cutting across institutions and disciplines. This strategically important function mutually reinforces outcomes of our country's educational, scientific and industrial R&D initiatives and helps transform the S&T landscape of the country.

The major challenges that the year 2020 put before the world helped India emerge as a forerunner in underscoring the critical role of science and technology in bringing positive transformations for a safe secure, better society well prepared for the future. The country leapfrogged into one of the top nations in science technology indices and reached laudable positions in several domains of science technology and innovations.

Some of the key success stories of DST during the year include:

- i. India's attained 3rd position in terms of number of publications in science citation journals, as per NSF database, number of PhDs in science and engineering as well as in terms of number of Startups. India featured within the top 50 innovative economies globally (at 48th rank), as per Global Innovation Index (GII).
- ii. The country is a key mover of global S&T efforts in vaccine research, development and supply, and global partnership on artificial intelligence (GPAI) to name a few. India was elected as Chair of the World Health Organization's (WHO) executive board.
- iii. The draft of the 5th Science, Technology, and Innovation Policy released for public consultation
- iv. S&T became core of decision making, claimed increased media space, gained public trust. Seamless industry-academia collaborations and inter-disciplinary partnerships led to quicker solutions and products in an energised STI ecosystem in 2020.
- v. DST's programmes triggered extraordinary performance of innovation ecosystem. *NIDHI* & *MANAK* programs made some major impacts on India's Innovation ecosystem
- vi. A victorious march to combat COVID 19 with the kind of innovations and startups that address COVID-19 challenges led to a slew of technologies, diagnostics & drugs, disinfectants & sanitizers, ventilators & medical equipment, PPEs and informatics at solutions to contain, treat and manage the pandemic that was unfolded due to an

exceptional sharing of purpose, synergy, collaboration and cooperation that R&D institutions, Academia and Industry have demonstrated in these months.

- vii. A Mathematical model 'COVID-19 India National Supermodel' predicts the rise and fall of the pandemic
- viii. The National Super Computing Mission (NSM) rapidly boosting High-Performance Computing (HPC) in the country to meet the increasing computational demands of academia, researchers, MSMEs, and startups in oil exploration, flood prediction, genomics, and drug discovery.
- ix. Centres with sophisticated analytical infrastructure established to provide state of the art equipment facilities for high-end analytical testing to researchers.
- x. New S&T areas of Cyberphysical systems like AI, Robotics, IOT receive big boost with research support & innovation hubs through the the National Mission on ICPS.
- xi. Climate change research marked by impactful publications & establishing centres of excellence in Himalayan Universities
- xii. Celebration of science invites attention of top dignitaries with Hon'ble President gracing the celebration of the National Science Day (NSD) for the first time.
- xiii. Guidelines set up urging institutions of higher education and research to support diversity, inclusion and equity through GATI.
- xiv. SCTIMST's proactive efforts help combat the pandemic with several technologies and products that could be crucial to combat the diseases.
- xv. Survey of India launched Pan India High-Resolution Geospatial Mapping to have Ultra High-resolution National Topographic Data
- xvi. SERB launches POWER for women researchers to promote women researchers in regular service with a personal fellowship and a research grant to top performing women researchers
- xvii. Phenomenal white paper by TIFAC provided recommendations for Focused Interventions for 'Make in India after the COVID 19 pandemic
- xviii. Scientists from IIA & ARIES collaborated with Nobel laureate on Thirty Meter Telescope (TMT) project being installed in Hawaii
- xix. BSIP scales up COVID testing facilities, becoming the top institution throughout the country in terms of average processing time of samples
- xx. RRI achieves first successful implementation of a highly secure efficient Quantum Cryptographic scheme

The report presents a detailed account of achievements of Department's activities during the year in relevant chapters. However, a gist of major achievements and initiatives of 2020-21 is presented in the following sections:

Fund for Improvement of S & T Infrastructure (FIST) in Universities and Higher Educational Institutions is currently operated in competitive mode of support at four levels. The financial support circumscribes four basic purposes i.e. Equipment, Networking & Computational Facilities, Infrastructural Facilities and Maintenance. Depending on the level, the total financial support is limited to Rs 1.50 Crore, Rs 3.0 Crore, Rs 10.0 Crore and Rs 20.0 Crore for Level 0, Level I, Level II and Level III, respectively. 86 proposals out of 837 were selected for consideration of financial support. selected Logo for FIST 2.0 was launched. The program is to focus towards supporting interdisciplinary problems, solution-centric and translational research, and increasing the scope for participation of industries and startups and new ideas, aiming towards Atmanirbhar Bharat'

"Promotion of University Research and Scientific Excellence (PURSE)": The main objective of the scheme is to pro-actively support for strengthening the R&D base of the performing Universities. It is formulated on the basis of 10 years aggregate publications and h-index towards creating and nurturing the research ecosystem among performing universities in the country. Using transparent criteria forty-four (44) performing universities have been supported ranging from Rs 30.0 Crores to Rs 6.0 Crores for 4 years' period based on publication output in Scopus International Database.

Sophisticated Analytical Instrument Facilities (SAIF) have been established in different parts of the country to provide services of the facilities of sophisticated analytical instruments. There are at present 15 Nos. SAIF Centres in the country. Approximately 2,000 research papers were published with the support provided by the SAIFs during the year and about 30,000 users from Pan India, belonging to all sectors have utilized and benefitted from the facilities at SAIF.

Sophisticated Analytical & Technical Help Institutes (SATHI) is setting up a shared, professionally managed services and strong S&T infrastructure facilities for intensifying the base of S&T infrastructure and manpower, S&T led innovation and start-ups, technology development and futuristic areas of S&T. Three SATHI facilities have been hosted in first phase at (i) IIT Delhi, (ii) IIT-Kharagpur and (iii) BHU- Varanasi. Each of them is supported with Rs. 125 crores spread over 3 years duration. During August 2020 a dedicated logo designed for SATHI program was launched.

State S&T Programme facilitates states to achieve the specific S&T objectives at their level. During the year, 28 State Councils were supported. The programme also supports studies and surveys on local S&T related issues etc. A State S&T Ministers Conclave (SSTMC) was organized on 23rd December 2020 at sixth India International Science Festival (IISF) on the theme of 'Post COVID-19 Livelihood Opportunities-Rebooting the System' in order to bring

out strategic action plans at state level to create livelihood opportunities.

Three **Policy Research Centers (PRC)** have been supported by DST in institutions across the country to understand STI processes for making effective policies, strengthen them and link these evidences to policy making. Fourth cohort of the STI policy fellowships was awarded to 15 fellows at different levels. The new STI policy formulation process has been initiated and the first draft of the policy is now out for public consultation.

Centre for Human and Organizational Research Development (CHORD) conducts national surveys to generate and make available information on manpower as well as financial resources devoted to S&T activities. The new publications “Research and Development Statistics, 2019-20”, along with the abridged version “R&D Statistics at a Glance 2019-20”, and “S&T Indicators Tables, 2019-20” were brought out. These publications serve an evidence base for the policy formulation in the S&T sector.

National Programme for Training of Scientists & Technologists working in Government Sector: With all the challenges due to the COVID-19 pandemic, 38 online training programmes were approved under this scheme during 2020- 21 under the program. About 850 scientists will benefit from these training programmes.

KIRAN (Knowledge Involvement in Research Advancement through Nurturing) embraces women-exclusive schemes of DST with the mandate to bring gender parity in S&T through various mechanisms. 600 ongoing projects and 122 new projects were supported under WOS-A. Total of 111 women completed the 11th batch of training under WOS-C. Out of the total women trained in 11th batch, about 60% of the trained women scientists are actively pursuing their career in the area of IPR. Student internship and fellowship. The new initiatives under KIRAN are further strengthening the objectives of this scheme and started support from the young age through ‘Vigyan Jyoti’ and also started mentoring of institutions for transforming them towards more inclusive and sensitive approach through ‘GATI’.

Innovation in Science Pursuit for Inspired Research (INSPIRE) is to attract talent to the study of science from an early age and build the required human resource pool for strengthening and expanding the R&D base and the Science & Technology (S&T) system of the country. 10,190 INSPIRE scholarships were offered during the year. 303 INSPIRE Fellowships were offered during the year. 668 INSPIRE Faculty Fellows received their Fellowship including 99 new INSPIRE Faculty Fellows.

The “**Million Minds Augmenting National Aspirations and Knowledge (MANAK)**” programme brought 3.8 ideas from middle and high schools across the country, out of which some brilliant ones have been shortlisted for showcasing at district, state and then at the National Level Exhibition & Project Competition.

International Cooperation established active bilateral S&T programs of cooperation with more than 46 countries including dedicated program for Africa, ASEAN, BRICS, EU and

neighboring countries. DST initiated process for the international scientific cooperation against COVID-19 with several countries. Several multilateral regional cooperation programmes with ASEAN, BIMSTEC, BRICS, EU, SCO, including joint R&D calls and research fellowships were conducted. Other initiatives include Industry Academia Conclave, Technology Summit, Global R&D summit, VIABHAV, PRABHASS, overseas S&T ministers' conclave, etc.

National Mission on Nano Science & Nano Technology promotes basic research and focuses on Nano Technology adaptation and transfer to industry for use by masses. In addition to the support for R&D and Technology-oriented projects, special calls to solve challenges due to COVID 19 was also offered and provided financial support mainly towards, mass manufacturing of masks and PPEs.

Activities under **Mega Facility for Basic Research** include its support for Antiproton and Ion Research (FAIR), Darmstadt, Germany, Experiments at the Large Hadron Collider (LHC) at CERN, Geneva, India-based Neutrino Observatory (INO), Madurai, Thirty Metre Telescope (TMT) Project, Laser Interferometer Gravitational-Wave Observatory (LIGO) Project, Accelerator-based Research Facilities, etc.

Under **Climate Change Programme**, two national missions on climate change under National Action Plan on Climate (NAPCC), viz., National Mission on Strategic Knowledge for Climate Change (NMSKCC) and National Mission for Sustaining the Himalayan Ecosystem (NMSHE) are being implemented. A study published in journal 'Science' showed planetary wave from the North Atlantic is capable of derailing the Indian monsoon. Research published in the journal 'Atmospheric Chemistry and Physics' showed that aerosols increased incidents of high rainfall in the Himalayan foothills

Multiple supercomputers of varying capability, ranging from a few 100 Tera FLOPS to Ten's of Peta FLOPS would be set up across the country under the **National Supercomputing Mission (NSM)**. Under NSM Phase-II, C-DAC has commissioned one HPC system of 1.3 PF (1.6PF Peak) at IIT Kanpur and two HPC systems of 650 TF (800TF Peak) each at JNCASR Bengaluru and C-DAC Bengaluru.

Technology Fusion & Applications Research (TFAR) Programme is meant to boost research in emerging technologies under single platform with the focus research for fusion, convergence and application of emerging technologies like Quantum Enabled Science & Technology, Network Project on Imaging Spectroscopy and Applications (NISA), Epidemiology Data Analytics and Indian Heritage in Digital Space.

Technology Development Programme supports R&D for development of innovative technologies in identified areas. A Centre of Excellence was established at CBRI, Roorkee to study the architecture and material analysis under SHRI programme. 9 Technology Enabling Centres and 2 satellite centres are established in Universities to bridge the gap between technology development and incubation activity. TDP has supported 44 new projects under various sub schemes.

Clean Energy Research Initiative (CERI) covers the research spectrum of entire gamut of clean energy. Several new dimensions were added to the programme to accelerate the pace of clean innovations to meet national needs. The initiatives include System Mission Innovation Challenge: Smart Grids and Affordable heating and cooling buildings, Clean Coal technologies, Methanol & Methyl Ether, Solar Energy, etc. **Water Technology Initiative** aims to promote RD&D activities which enable winning of water from sustainable sources, augmentation of water quality for specific applications and recycling and reuse of water.

National Geospatial Programme (NGP) aims at promoting R&D in emerging areas of Geospatial technologies and applications. First and only National Centre for Geodesy (NCG) has been established by DST at IIT Kanpur.

NSTEDB through its strong network of incubators is leveraging the technological strength of the higher learning institutes to the benefit of the start-ups. The impacts of NIDHI in nurturing national innovation and entrepreneurship ecosystem include nurturing of 3,681 startups through a network of 153 incubators created by DST, which generated 65,864 jobs as cumulative direct employment, created a wealth of Rs 27,262 crores and generated 1,992 intellectual property. NSTEDB has adopted a multipronged approach by targeting its program offerings into the following ecosystem subcomponents (or fronts). During the year 2020-21, NSTEDB is extending support for establishing seven new TBIs under NIDHI program. As a rapid response to tackle the extraordinary situations created by the COVID 19, a new program, CAWACH (Centre for Augmenting War on COVID 19 Health Crisis) was rolled out to support the Indian Science and Tech startups and the initiative came out with extraordinary responses on various fronts.

National Council for Science and Technology Communication (NCSTC) largely aims at communicating and popularizing science and technology (S&T) to masses and stimulate scientific temper amongst them. The National Science Day was celebrated on 28 February 2020 on the theme, 'Women in Science' with Hon'ble President of India inaugurating the event.

Science for Equity for Empowerment and Development (SEED) scheme supports several field based programs with the application of S&T linked to directly benefitting the society has been implemented under. Long term Core Support is extended under Technological Advancement for Rural Areas (TARA). Action oriented Initiatives under SEED division are steps towards contributing to the National initiative for "AatmaNirbhar Bharat" by empowering communities through STI at the local level for socio-economic well-being with environmental considerations and to contribute to UN-SDGs as well. Several initiatives related to COVID 19 pandemic were taken up during the year for the local communities.

Interventions through the **Tribal Sub-Plan** had directly benefitted 6000 people, in addition to improved socio-economic status there had been a significant improvement in skills, building on local innovation & local knowledge.

The projects implemented (completed) through the **Scheduled Caste Sub Plan** during the year directly benefitted around 10,000 people and there has been a significant improvement in the socio-economic conditions of people.

Under **Drugs and Pharmaceuticals Research Programme (DPRP)**, Program, has setup the following 2 National Facilities in year.

Seven new test facilities were granted the **Good Laboratory Practice (GLP)**-compliance status. As on date, there are 50 GLP certified test facilities in the country. The OECD has acknowledged the contribution of the Indian GLP program and designated India as the Vice-Chair of the OECD Working Group on GLP for 2021 and 2022.

Patent Facilitation Programme (PFP) has provided financial support to 24 Patent Information Centers established at various State Councils. Different organisations had filed 12 new patent applications after due assessment of patentability of 43 new requests.

Five **Technical Research Centres (TRCs)** were established in 5 DST institutions in 2015-16. The TRCs have developed and transferred some significant technologies to industry during the period. These TRCs provide techno-legal-commercial and financial support to scientists, entrepreneurs, and business fraternity to achieve translation of research into products and processes for greater economic and societal benefits.

The Exhibition Cell organized different exhibitions to bring awareness among students, scholars and general public about different Government policies, schemes, scientific innovations & milestones in the field of Science & Technology.

NSDI has been on demonstrating the National Data Registry (NDR) Geo-portal and the individual organisational Data Nodes; provisioning a proof-of-concept Geospatial Cloud based Infrastructure (NSDI Geo-platform) services for hosting geospatial data/ applications; maintaining the NSDI Clearinghouse Node.

The **Integrated Cyber Physical Security (ICPS)** programme initiated during the year 2018-19 supported several projects in the areas of Data Science Research Initiative (DSRI), Internet of Things Research Initiative (IoTRI), Cyber Security for physical infrastructure (CSRI), Quantum Enabled Science and Technology (QuEST). Its unique architecture of 25 innovation hubs and parks set up across the country is bringing about strong collaboration and co-ownership among industry, academia, and government, connecting them with full flexibility. It plans to build linkages and collaborations with network of research institutes and labs across India and abroad.

The Department of Science and Technology nurtures 25 **Autonomous Bodies (ABs)**. These include 16 research institutions, 4 specialized knowledge institutions and S&T service organizations and 5 professional bodies. These institutions have a long and varied history and their variety of activities significantly contribute to the S&T eco-system of the country. Many of

the AIs has contributed significantly with many innovative technology products and solutions to deal with the challenges due to the COVID19 Pandemic. The one step confirmatory diagnostic kit for COVID 19 developed by SCTIMST that responded to India's urgent need for rapid testing. A phenomenal white paper on "Focused Interventions for 'Make in India': Post COVID 19" prepared by TIFAC provided recommendations for giving immediate technology and policy impetus to make India 'Atmanirbhar Bharat' Some of the institutes also facilitated the RT-PCR testing support with their Laboratory facilities.

The **Science and Engineering Research Board** has come up with several innovative programmes and schemes to identify potential scientists and support them for undertaking R&D in frontier areas of Science and Engineering. Some of the flagship programmes include Early Career Research Award, National Postdoctoral Fellowship, Ramanujan Fellowship, Visiting Advanced Joint Research (VAJRA) Faculty Scheme, IMPRINT (Impacting Research Innovation and Technology), Mathematical Research Impact Centric Support (MATRICS) Scheme, International Travel Support (ITS) scheme, SERB-TETRA, SERB-SUPRA, SERB-VORTEX, SERB-STAR, etc. Some of the new initiatives during the year include SERB-POWER, SERB on Covid-19, etc. A COVID super model to simulate the spread of the COVID 19 pandemic in the country has give very interesting results with correctly projecting the spread.

TDB provides financial assistance to the industrial concerns and other agencies attempting development and commercial applications of indigenous technology or adapting imported technology for wider domestic application. TDB issued a call for proposal "Fighting COVID-19" and invited proposals/applications from Indian companies and enterprises to address the unprecedented situation of COVID-19. Through online process, nearly 350 companies registered themselves and approximately 225 applications were received. Some of the supported companies include M/s Mylab Discovery Solutions, Pune for the project proposal entitled "Manufacturing of Testing Kits to detect Covid Corona Virus".

Under the **Strengthening survey and mapping** activity through Survey of India and NATMO, has made some significant contributions with some geospatial solution to deal with the COVID 19 challenges. With the efforts by Sol, India joins the select club of few nations to have Ultra High-resolution National Topographic Data as foundation data. This effort has been launched in three States - Haryana, Maharashtra, and Karnataka and also for the Ganga basin

The Department has made every effort to utilize the allocated budget fruitfully to implement its planned activities and programmes during the year. The Department of Science & Technology and its various Autonomous Institutions made some significant efforts to address R&D and innovation related challenges arising out of COVID-19 pandemic.

S&T INSTITUTIONAL & HUMAN CAPACITY BUILDING PROGRAMME

1.1 R&D Support (FIST, PURSE, SAIF)

Department implements couple of Programs dedicatedly for Scientific Infrastructure Building i.e Fund for Improvement of S & T Infrastructure in Universities and Higher Educational Institutions (FIST), Promotion of University Research and Scientific Excellence (PURSE), Sophisticated Analytical Instrument Facilities (SAIF) and “Sophisticated Analytical and Technical Help Institute” (SATHI) Program

1.1.1 Fund for Improvement of S & T Infrastructure in Universities and Higher Educational Institutions (FIST)

“**Fund for Improvement of S& T infrastructures in Universities and Higher Educational institutions (FIST)**” Program is flagship program of Department of Science & Technology which facilitates support towards augmenting basic infrastructural facilities for conducting research in basic or applied science areas at the university and academic sectors.

The FIST program provides support at the departmental level for augmenting basic infrastructural facilities including Equipment, Networking & Computational facilities, Infrastructure and Maintenance for conducting research in basic or applied science areas. The scheme is currently operating in a competitive mode through a four-level support and each level depicts a different quantum of support that is provided depending upon the type of organization as well as its existing R&D profile and future research vision. Depending on the level, the total financial support is limited to Rs 1.50 Crore, Rs 3.0 Crore, Rs 10.0 Crore and Rs 20.0 Crore for Level 0, Level I, Level II and Level III, respectively. The selection is through a peer review mechanism and visit to the organization, if necessary.

The program provides support in six subject areas (Life Sciences, Physical Sciences, Chemical Sciences, Engineering Sciences, Earth & Atmospheric Sciences, Mathematical Sciences) and Post Graduate Colleges.

Similar to previous years, this year also the FIST Program was announced at the DST website for inviting fresh proposals from the potential departments from Universities and other Academic Institutions across the country. The last date of submission of proposals was 31st May 2020. A total of 837 Proposals were received through online mode in the current year in different subject areas Life Sciences, Physical Sciences, Engineering Sciences, Chemical

Sciences, Earth & Atmospheric Sciences, Mathematical Sciences and PG-Colleges have been received online from departments of universities and academic institutions exclusively. The screening and presentation meetings in seven subject areas were organized in the current year.

Since the initiation of the program in 2000, nearly 2912 S&T departments and PG colleges have been supported/recommended. 2912 S&T departments and PG colleges have been supported/recommended with a total investment of about Rs 2970 crores spread over ~650 academic institutions, since the commencement of the program in year 2000. About 480 PG Science/ Engineering/ Medical Colleges have undergone rejuvenation of teaching and research facilities since initiation of the program.

FIST Program has been instrumental in establishing state-of-the-art facilities for performing high end research and have thus benefited academicians and researchers across the country. The Program has made significant research impact in many departments across the country to carry out advanced research in contemporary areas of science and technology. The researchers are benefited so that their potential is tapped for scientific advance and innovation.



Fig. Micro Raman Spectroscopy facility at Department of Physics, IIT Indore

The realm of the FIST Program has produced scientific infrastructure in many prestigious medical/ veterinary/ paramedical institutions in the country like All India Institute of Medical Sciences, New Delhi; Sanjay Gandhi Post Graduate Institute of Medical Sciences, Lucknow; Postgraduate Institute of Medical Education and Research, Chandigarh; Maulana Azad Medical College, New Delhi; University College of Medical Sciences, Delhi; Mahatma Gandhi Institute of Medical Sciences, Wardha; JIPMER, Pondicherry; Christian Medical College, Vellore; Cancer Institute, Chennai; All India Institute of Speech and Hearing, Mysore; Institute of Post-Graduate Medical Education & Research, Kolkata etc.

Over the years, the FIST Program has played a pivotal role in strengthening of both the teaching and research infrastructure in different academic and research institutions and changed the infrastructure landscape of these organizations, across the Nation.

1.1.2 b) Promotion of University Research and Scientific Excellence (PURSE)

“**Promotion of University Research and Scientific Excellence (PURSE)**” is a proactive measure of DST to build the research capacity of performing Indian Universities. The main objective of the scheme is to pro-actively support for strengthening the R&D base of the performing Universities. It is formulated on the basis of 10 years aggregate publications and h-index towards creating and nurturing the research ecosystem among performing universities in the country.

The support under PURSE is provided to acquire research facilities, research man-power cost, augmentation of computational facilities, establishing research infrastructure, acquiring research consumables, fund for travel, organizing workshops and conferences, contingencies and maintenance of the facilities. Total investment of Rs 1220 crore was planned for performing Universities identified under PURSE, so far an amount of Rs 950 Cr has been made available to the performing Universities this scheme.



Fig. High Performance Thin Layer Chromatography (HPTLC) at University of Kerala established out of DST PURSE



Fig. Capillary DNA Sequencer System at Bharathiar University, Tamil Nadu established out of DST PURSE

In PURSE Scheme, as suggested by the Third Party Evaluation, introduction of I_{10} index of faculty members in the University, along with the h index and Mission mode based restructuring of PURSE Universities to focus on thrust areas which align with National priorities of Excellence in Manufacturing, Waste processing, Clean Energy, Water and Start up India has been used to formulate the new criteria for selection of Universities under PURSE. Based on the Third Party Evaluation, the Department has announced new call to invite the proposals under PURSE in August 2020. The Tenth Meeting of Programme Management Board on PURSE was organized in December 2020 to review the ongoing universities under PURSE and also to shortlist the applications received against the call of PURSE. The selection of Universities under PURSE with the revised criteria as suggested by the Third Party Evaluation is under process.

1.1.3 Sophisticated Analytical Instrument Facilities (SAIF)

Sophisticated analytical instruments are vital for pursuing research in many areas of modern science and technology. Although, research infrastructures in different Universities/institutes have been augmented and modernized in the last two decades, many institutions in the country still lack the existence of specialized facilities to carryout both basic and advanced research in contemporary areas of Science and Technology. These sophisticated instruments are expensive and are seldom provided through individual project mechanism. Moreover, these instruments are of inter/multidisciplinary utility and thus it is desirable to use them on sharing basis for their optimum utilization. Considering these aspects, the Department of Science & Technology (DST) has set up Sophisticated Analytical Instrument Facilities (SAIFs) in different parts of the country under its Sophisticated Analytical Instrument Facilities Programme to provide the facilities of sophisticated analytical instruments to the research workers in general and specially from the institutions which do not have access to such instruments to enable them to pursue R&D activities requiring such facilities and keep pace with developments taking place globally.

At present 15 SAIFs are being supported by DST at IIT, Chennai; IIT, Mumbai; CDRI, Lucknow; Punjab University, Chandigarh; NEHU, Shillong; IISc., Bangalore; AIIMS, New Delhi; Gauhati University, Guwahati; C.V.M., Vallabh Vidyanagar; STIC, Kochi; Shivaji University Kolhapur; IIT Patna; IEST Shibpur; M.G. University, Kottayam and Karnataka University Dharwad.



Fig. Students viewing their samples with Tecnai G²-20 Transmissions Electron Microscope at SAIF AIIMS, New Delhi

SAIFs are equipped with instruments such as X-ray Diffractometers, Thermal Analysis Systems, Transmission Electron Microscopes, Mass Spectrometers, Nuclear Magnetic Resonance (NMR), ICP etc. to meet the need of research workers. SAIF facility is accessible to all the users from various academic institutes, R&D laboratories and industries, irrespective of whether they belong to the host institute or not.

Major Highlights of year 2020-21

The first meeting of this reconstituted Steering Committee was held in month of Nov 2020

through virtual mode. Thirteen SAIF Centres projected their requirement via a presentation to the Committee. The Committee has reviewed performance of all the centres and recommended new instruments for strengthening of R&D infrastructure to Seven SAIF centres. The Steering Committee recommended COVID Relief package to the SAIFs centres to cope with the losses they faced and keep the facility running. Steering Committee has recommended “COVID Relief Package” to the SAIFs in managing their recurring expenses during Pandemic time. The Steering Committee also has recommended conversion of SAIF Centre at Shivaji University Kolhapur; IIT Patna; IEST Shibpur; M.G. University, Kottayam and Karnataka University Dharwad, to a regular SAIF centre where DST will keep on strengthening the R&D Infrastructure facilities at the centre.

The facilities at SAIF are meeting analytical needs of researchers, scientist and industries for material characterization including qualitative/quantitative analysis, structure determination, surface topographic studies etc. Approximately 2,000 research papers were published with the support provided by the SAIFs during the year and about 30,000 users from Pan India, belonging to all sectors have utilized and benefitted from the facilities at SAIF. An average of 90,000 samples were analyzed by the 15 SAIF centres. A series of webinars were organized by SAIF centres on topics related to Nuclear Magnetic Resonance, Transmission Electron Microscopy, and Scanning Electron Microscopy. Approximately 30 such webinars were hosted by SAIFs during this year.

DST sponsored Sophisticated Analytical Instrument Facility (SAIF) at Panjab University, Chandigarh has developed Disinfection devices in response to the situation arising out of Covid-19 pandemic. In series of such devices, the SAIF Centre has designed and developed a device for the disinfection of currency notes and an “Ultraviolet Sanitization Chamber” for disinfection of articles and papers. The unit is installed at entry gate of the SAIF Centre to disinfect the samples coming for analysis. This in-house fabricated device is also supplied to different offices/departments of Panjab University and Chandigarh Administration such as VC office, Registrar office, IG office Chandigarh police.

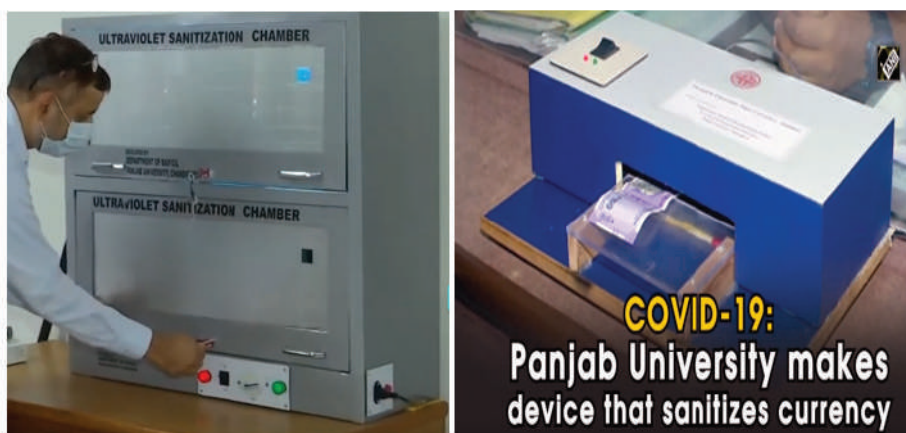

1.1.4 Sophisticated Analytical & Technical Help Institutes (SATHI)

For intensifying the base of S&T infrastructure and manpower, S&T led innovation and start-ups, technology development and futuristic areas of S&T, DST is setting up a shared, professionally managed services and strong S&T infrastructure facilities. This new initiative is known as **S**ophisticated **A**nalytical & **T**echnical **H**elp Institute (**SATHI**) program. SATHI envisages equipping with major analytical instruments to provide professionally managed common services of high-end analytical testing, variety of designing, prototype development, manufacturing, inclusion of business planner, testing and fabrication with efficiency, accessibility, open access policy and transparency of highest order under one roof to deal the demands of researchers, scientists, students, start-ups, manufacturing units, MSME, industries and R&D Labs and thus avoiding duplication and reduced dependency on foreign sources.

SATHI will foster a strong culture of collaboration between institutions and across disciplines to take advantage of developments, innovations and expertise in diverse areas. Till now three SATHI centres are running and more to be supported in coming days under R&D infrastructure division. Three SATHI facilities are hosted in first phase at (i) IIT Delhi, (ii) IIT-Kharagpur and (iii) BHU- Varanasi. Each SATHI facilities is supported with Rs. 125 crores spread over 3 years duration, starting from current FY 2019-20. During August 2020 a dedicated logo designed for SATHI program was launched by Secretary DST in presence of Director(s), IIT Delhi, IIT Kharagpur & VC of BHU, stakeholders of SATHI and other invitees convened on Microsoft Teams (Below pics for reference).



Dedicated building with suitable infrastructure, such as uninterrupted supply of utility like electricity, water, sanitation, internet connection etc at the available space of (more than 20000 Sq. ft., within single building location) are depicted below for all three SATHI facilities.



SATHI FACILITY – at IIT DELHI



SATHI FACILITY – BHU – VARANASI



SATHI FACILITY – IIT KHARAGPUR

During August 2019 website of SATHI facility (<http://crf.iitd.ac.in/sathi/index.html>) hosted at IIT -Delhi inaugurated and launched by both Director-IIT Delhi and Secretary-DST, Website of SATHI facility (<http://anandkanan.in/equipment/>) hosted at BHU- Varanasi inaugurated and launched by both Vice-Chancellor, BHU- Varanasi and Secretary-DST and Website of SATHI facility (<http://www.sathi.iitkgp.ac.in/>) hosted at IIT -Kharagpur inaugurated and launched by both Director-IIT Kharagpur and Secretary-DST for wide outreach and publicity (following Pics for reference).



Inclusive purpose of SATHI is generation/ creation of knowledge adopting best practices of such facility, expansion of different knowledge chain that starts from R&D to applied science then to translational research side and how to take forward to next stage to gain better societal outreach. Predominantly it would emphasize on testing, designing, prototyping, proof-of concept, manufacturing, insertion of business planner, start-ups, MSME, related engineering industries and their back & forth connectivity from R&D to industry and then to boost indigenous presence comprising all level together at local and global scale. Perceptibly, this would encourage & ensure to create a National Network of Laboratories and testing facilities, tightly linked to global standards. Hence higher efficacy through (T2C2) focused Viz: Technology, Testing, Certification & Compliance, approach will boost-up the manufacturing clusters / industries.

1.2 State Science & Technology Programme

The Department of Science and Technology (DST), government of India is nurturing Centre-State S&T cooperation through State S&T Programme (SSTP). Through this programme DST provides budgetary support to State S&T Councils for their S&T human resources and some infrastructure besides funding support for location specific research through liaison with Central/State academic institutions & laboratories, technology development and demonstration. The programme also supports studies and surveys on local S&T related issues etc. As a result of the support, the State S&T Councils perform activities to strengthen the bottom of the pyramid of State S&T landscape viz. awareness, creation, capacity building etc., the R&D ecosystem and the innovation ecosystem in the State.

In the year 2020-2021, Annual Meeting of SSTP was conducted virtually during June 18 to July 1, 2020 to review the progress of the various State S&T Councils in the country. Around (number) States & Union Territories Councils participated in the Conclave and discussed the future course of actions to be taken for S&T development in States.

1.2.1 Significant achievements of some of the State S&T Councils under the State S&T Programme during 2020-21

Arunachal Pradesh State Council for Science & Technology (APSCST)

- The Council has initiated establishing Rural Appropriate Technology Demonstration Centre (RATDC) at Kimin, Papumpare district of Arunachal Pradesh. The centre aims to impart skill training and provide economic sustainability to the rural population of the state. Procurement of instruments, training of the technical staff, cultivation of citronella, and technology transfer from respective CSIR Institutes are currently being carried out.



The future prospects will involve training for the farmers, entrepreneurs, and women of the state on different aspects of entrepreneurial skills using science and technology intervention for economic sustainability.

- The Centre of Excellence (CoE) in Bio resources and Sustainable Development at APSCST selected unexplored wild edible and ethno medicinal important plant species for nutritional profiling and phytochemical characterization. The CoE enlisted 35 alpine species from state among which eight taxa seem to be new records for Arunachal Pradesh. The bacterial isolates of the alpine areas of the state have been identified using the 16s rRNA techniques. The phylogenetic analysis of isolates found it similar to important psychrophilic microbes recorded from Himalayan glacial regions.
- The council also undertook soil nutrient profiling of the agricultural field of Kimin area to identify beneficial bacterial diversity and for their plant growth-promoting activities (PGP).
- To meet the energy requirements of Kimin General Hospital, Papumpare district a technology demonstration on Geothermal energy for heating and cooling system was taken up by the Council.
- Study on Traditional alcoholic beverage “Black Apong, Chang” for its Preservation and Commercialization was undertaken in collaboration with Chemistry Department of Dibrugarh University, Dibrugarh, Assam. Efforts are being made to preserve this beverage up to 8-12 months by using other stabilizing agents such as potassium sorbate, sodium benzoate etc., control alcohol production within 11-12% (v/v) by fermenting ~130-140 hours and reduce colloidal instability, caused mainly by interactions between polypeptides and poly-phenols.



- Rainwater Harvesting System was set up at Arunachal Pradesh Science Center to encourage and sensitize the local populace on the importance of water conservation as well as to demonstrate the technology.

Assam Science Technology & Environment Council (ASTEC)

- The Assam Remote Sensing Application Centre (ARSAC) at ASTEC has developed a Web-based GIS application for Rashtriya Uchattar Siksha Abhiyan (RUSA) for planning and information.
- The Council conceptualized, Designed & Developed of a pedal propelled vehicle to collect and dispose of household solid waste in municipal areas considering ergonomic & usability factors in association with Department of Mechanical Engineering, Assam Don Bosco University.



- 3D printing & doodling a platform for students to run their ideas into reality; Mind-Bending a science and mathematics-based Puzzle competition; Mathematics made easy an interactive session with renowned mathematician and demonstration of Mobile Science was conducted.



- Environmental Information System Hub to collate and disseminate information on the status of the environment of the state and its related issues. Further, the hub was involved in skilling students through its Green Skill Development Programme (GSDP). Under the National Green Corps Programme, plant diversity centers, environment, and climate Cells were set up at schools.



- Development of traditional technology (location specific), indigenous goods industry by Geographical Indication (GI) registration, Food Processing Technology, application of Remote Sensing, and Geographical Information System (GIS) in Natural Resource Management are the major activity sector of the council. RS & GIS-based mobile application was developed for specific governance application, such as Crime GIS on a pilot basis.
- Patent Information Centre (PIC) at ASTEC supported filing of 7 patents to inventors. PIC extended support to the inventors/innovators in registering their Intellectual Property (IP) and created awareness on IPR.

Haryana State Council for Science, Innovation & Technology

- HSCSIT developed protocols for large-scale multiplication of Sugarcane, Sarpghandha, Banana, Bamboo, Brahmi, Gladiolus, Eucalyptus, Dahlia, Potato, Strawberry, Mehandi, Stevia and Aloe Vera at Centre for Plant Biotechnology, Hisar.



- The Council established a Renewable Energy Test Centre (RETC) at Deenbandhu Chhotu Ram University of Science & Technology to provide testing facilities to test Solar Thermal Gadgets, promote use of solar thermal systems for various applications and develop entrepreneurs for manufacturer of Solar Thermal Systems.



Fig. Thermal Performance Test Set-up

- The Patent Information Centre (PIC) at HSCSIT supported filling of 34 trademarks, 7 patents, 4 Industrial designs, 3 copyright applications and organized 20 workshops.

Uttarakhand State Council for Science And Technology (UCOST)

- UCOST in collaboration with Get Innovative Solution, Dehradun has installed a new innovative Magnetic Waste Reduction Machine (100kg capacity) at RSC Dehradun. The machine destroys any organic waste collected at source without using any power/fuel. This revolutionary machine works on the principle of low temperature pyrolysis process at temp of 350 to 400 degree driven by magnetic technology for destruction of non-segregated rejected waste, domestic waste and specific industrial waste. It has a capacity to reduce the output of destructed waste in the ratio of 1/300 times.



- At Technical Resource Centre (TRC), Kaleshwar customized techniques were designed for product development and it's safe and prolonged storage. Modern food processing machines i.e. Automatic Conveyor Sealer, Cold Storage, Fruits & Vegetable dehydrator, Inkjet Batch coding machine, Nut Decorticator, Oil-Press machine, Fruits & Vegetable Washing machine and vacuum packaging machines were instituted for use by community. A total of 14 high value products were developed and launched under the brand name 'Mountain Beam' from nutritionally rich traditional crops of Uttarakhand.

- A field-testing kit for water analysis (Semi-quantitative tests for Turbidity, pH, Hardness, Chloride, Iron, Nitrate, and Residual Chlorine, and Bacteriological Test) was developed.

Bihar Council on Science & Technology (BCST)

- The Council developed COVID-19 dashboard for planning and decision support to take appropriate strategic measures to curb COVID-19 in Bihar.
- The Council also undertook the challenge of *Parali* burning, a major threat to environmental pollution. The surveillance of *Parali* burning activities were mapped regularly by Bihar Remote Sensing Application Centre using Satellite images, for administration to take appropriate remedial action. The initiatives resulted in reduction of environmental air pollution. The centre was also involved in surveillance of sand and stone mining of the state using Remote Sensing & GIS, the surveillance activity assisted in curbing illegal mining and improving the revenue of State Government. The Centre started a new initiative to create an inventory of fishery resource i.e. ponds, lakes, waterlogged areas and other water bodies and forest/ tree cover of the Bihar. This will help in creating resource based livelihood opportunities.
- The Council also encouraged 10 grass-root innovators for documenting their innovations.

Madhya Pradesh Council Of Science & Technology (MPCST)

- The Council developed various GIS based technologies for modernization of the activities of various departments of Madhya Pradesh a crucial step towards Digital India. MPCST is the nodal agency for preparation of GIS based Master Plans of Madhya Pradesh (MP) in collaboration of Town & Country Planning Department, Government of MP. Madhya Pradesh is the first State in India to complete first Draft Master Plan based on AMRUT Guideline.

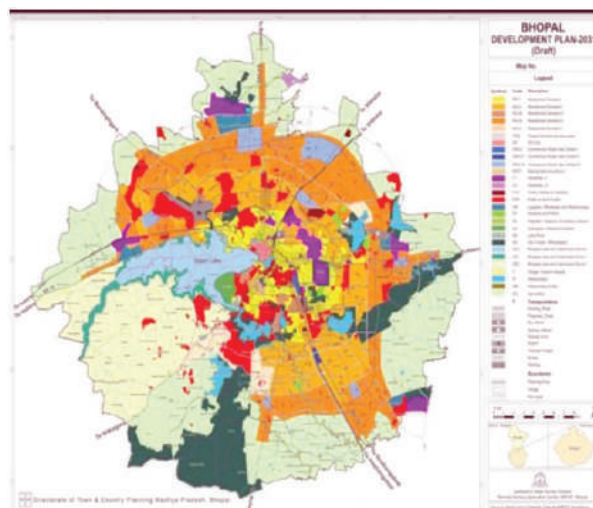

Fig. Bhopal Development Plan 2031

- The Council has created Ground Water Quality Map using GIS technique for all the districts of Madhya Pradesh.
- The Council has initiated mapping of Desertification and Land Degradation for monitoring vulnerability assessment and creating combat plans.

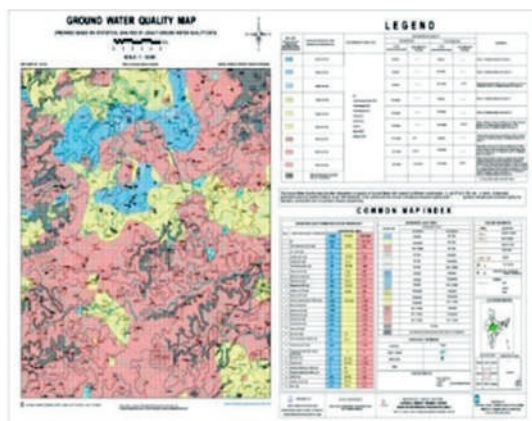

Fig. Ground water quality map

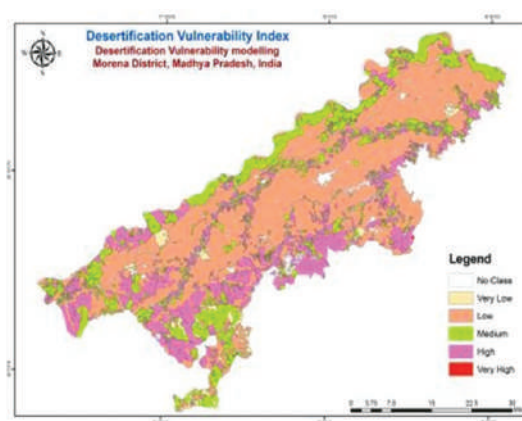

Fig. Desert Vulnerability Index of MP

Gujarat Council on Science & Technology

- Under its science popularization scheme GUJCOST initiated setting up of Five Regional Science Museums at Rajkot, Bhuj, Bhavnagar, Patan and Vadodara. It also established 18 Design Labs to create facilities for students and faculties for creative and innovative thinking.



- The Council also established supercomputing facility at 26 R&D Institutes to support upcoming area of big-data analytics. The facility was used during COVID 19 for surveillance and analysis of healthcare facility in Gujarat.
- Vikram Sarabhai Chair was established by GUJCOST during the centenary year celebration for interdisciplinary research and innovation in emerging areas of Science and Technology at IIT, Gandhinagar. This Chair will promote international collaborations and facilitate exchange programmes.
- GUJCOST developed a strong network of Community Science Centres in every district with involvement of 3000 School Science Clubs across the state to engage, educate and empower children and citizen at the interface of science technology and society.

Karnataka State Council for Science and Technology (KSCST)

- Under Village Information System programme a guideline to generate cadastral, settlement maps along with soil & water parameters using high resolution satellite images was developed. The Council completed mapping of five Gram Panchayaths covering 13 villages across Kodagu, Udupi, Mysore and Belagavi districts.
- E-Learning centres (virtual laboratories) were established by KSCST in 21 high schools across backward talukas of Karnataka to demonstrate the potential of E-Learning in improving the quality of school education through IT enabled software & tools. KSCST also deployed digital contents and 3D experiments based on state syllabus.
- KSCST assessed hydrological and physical status of traditional water harvesting systems in Karnataka using geo-spatial technologies and suggested measures for its restoration & rejuvenation.

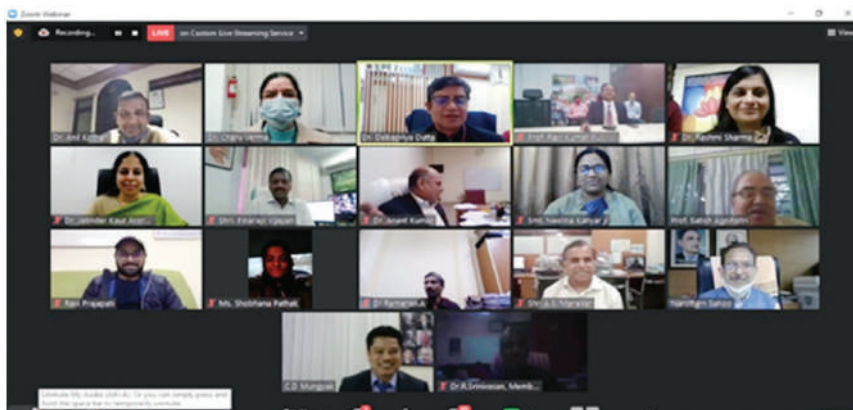

Fig. Kalyani in Rangasthala, Chikkaballapura taluk before and after rejuvenation

- Karnataka Geoportal has been extended to the National Data Registry Services.

State S&T Ministers Conclave (SSTMC)

To extend this dialogue of cooperation, State S&T Ministers Conclave (SSTMC) was organized on 23rd December 2020 at sixth India International Science Festival (IISF). The theme of this year's dialogue was 'Post COVID-19 Livelihood Opportunities-Rebooting the System' in order to bring out strategic action plans at state level to create livelihood opportunities. The conclave was attended by 7 State Ministers from Bihar, Goa, Madhya Pradesh, Puducherry, Rajasthan, Telangana and Uttar Pradesh and four Representatives of the State Ministers from Kerala, Punjab, Mizoram and Himachal Pradesh. The event also had participation of Secretaries of State Department of Science and Technology and Senior Officials of State S&T Councils of 28 States and UTs. The Conclave was inaugurated by Dr Harsh Vardhan Hon'ble Minister of Science and Technology, and resulted in suggestions from State Ministers for new areas of cooperation.



1.3 Policy research Programme

Policy Research Programme (PRP) (earlier 'Policy Research Cell') under Policy, Coordination and Programme Management (PCPM) division in Department of Science and Technology (DST) is mandated to promote STI policy research in the country and gather evidence-based input for policy making. In this regard, the department has established Centres for Policy Research (CPRs) in national academic institutes across the country and launched a policy fellowship programme (PFP) with the following key objectives:

- Strengthening the Policy Research Mechanism for facilitating evidence-based planning approaches.
- To generate critical mass of the policy researchers through the support of STI- Fellowships.

During the current year, three CPRs have been supported under the programme at 1) Indian Institute of Technology Delhi, 2) Punjab University and 3) Indian Institute of Science, Bangalore. Similarly, the fourth cohort of policy fellows have been awarded with the DST STI Fellowships in policy domain during the year.

1.3.1 Centres for Policy Research:

DST-CPR at IIT Delhi:

The DST - CPR at IIT Delhi was established in the FY 2013-2014 and has been contributing on policy research in different S&T sectors. In the FY 2019-20, the CPR was engaged in several research activities.

- A study on the 'Dynamics of co-evolution of grid and off-grid space in India: understanding the implications for entrepreneurs and rural electrification' explores the interaction between the expanding central grid and micro/mini grids and examines the implications of this relationship on rural electrification. It is observed that grid expansion has, to a

certain extent, disrupted micro/mini grids business but entrepreneurs have also come up with innovative and sustainable solutions as a response to this stress. The study argues that a healthy complementary relationship between the grid and micro/mini grids would be the best way forward for sustainable rural development.

- A study carried out on 'Too Much and Too Late: India's Renewable Energy Policy Evolution and its Implications for Indigenous Manufacturing' has found that India's Renewable Energy (RE) paradigm has undergone a substantial shift since RE first found a place in the official plans. Earlier, RE was conceptualized as the solution to rural energy access issue, specifically, the fuelwood crisis, in India's rural areas. Under this paradigm, the main focus of RE policy was utility scale grid connected solar with adoption of ambitious targets. Further, the shift was not gradual but rather abrupt and sudden. The substance and the nature of the paradigm shift has had a crucial impact on the development of indigenous solar manufacturing. The sudden adoption of ambitious RE targets prevented India time to develop its indigenous manufacturing like China did. Thus, the swift RE paradigm shift led India to focus too much on deployment while making it too late to build its solar manufacturing.
- The CPR has submitted three articles for publications & two reports have been brought out,

DST-CPR at Punjab University, Chandigarh:

The Centre has carried out evidence-based studies in the areas of Promotion of Public Private Partnership (PPP) for R&D; Identifying Areas of Policy Gaps for Stimulation of Private Sector Investment in R&D; Evidence Based Approaches for Identifying and Promoting Areas for Generation of Intellectual Properties and published findings in the form of Books, Reports and Research Papers. More than 20 conferences/workshops/seminars/symposiums have been organized in which officials/scientists of NITI Aayog, different Funding Agencies, O/o PSA, UGC, AICTE, Universities, National Research Laboratories and representatives from Industries (small, medium and large scale) and Industry Associations share their experiences.

In addition, the Centre has created an a) Industry-Academia web portal of Chandigarh region, b) Medical Device Innovation Cluster, c) Contributed significantly in drafting 'University Business Linkage Programme' for UGC and organized hands-on-training in the fields of 'Patent Search and Filing'. A few of the recommendations have been carried forward at the national level. Detailed information can be accessed from the Centre's website (<https://cpr.puchd.ac.in/>).

In one of the studies on Creation of 'Comprehensive PPP for R&D Web-portal', the centre has reported that World over, Public-Private Partnership (PPP) in R&D is being perceived as an important and effective tool to enhance the innovation index of the nation. The handshake

between the public sector (Academia and the government) and the private sector (primarily industries) is a win-win situation for both the entities. In India, there are magnitude of PPP in R&D programmes implemented by the public sector (DST, CSIR, BIRAC etc.) as well as the private sector (financial institutions and industry associations) as mentioned below .

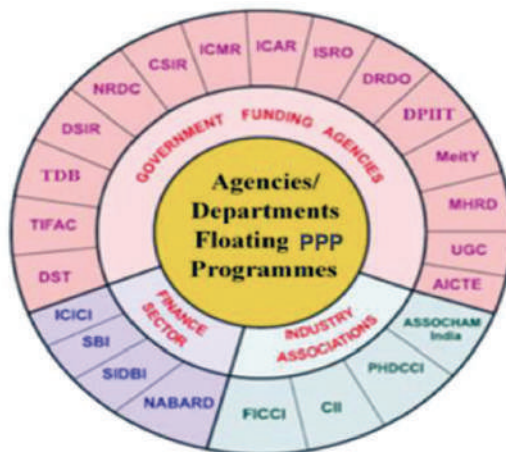

Fig. Agencies/ Departments Floating PPP Programmes

DST-CPR at Indian Institute of Science, Bangalore:

The DST - CPR at IISc Bangalore is mainly focused to investigate the Scientometric studies in which the following critical objectives has been targeted to address:

- Studying policies and mechanisms that can help increase the research impact of Indian institutions and thereby improve their position in global rankings
- Critically examining the different funding mechanisms and their efficacy in raising the research impact of Indian institutions

The CPR through its core research mandate in Scientometric Analysis of Indian STI ecosystem, has contributed to policy debates and decision making in areas such as Open Access to Scholarly Knowledge, Research Assessment & Evaluation Frameworks and Standardization of STI measurement indicators. More specifically, the centre has contributed to major policy-level decision making, including but not limited to, in the upcoming Science, Technology and Innovation Policy, India's Open Access Policy and India's engagement with OECD-Committee on Science and Technology Policy through the Office of PSA and DST.

The centre has published around 9 research papers, 3 reports and trained 5 interns through internship programme.

1.3.2 STI Policy Fellowship Programme

Apart from the CPR activities, DST has also been supporting the STI policy fellowship to highly motivated young professionals. The policy fellowship is being offered at three levels:

Senior Policy Fellows, Post-doctoral Policy Fellows and Young Policy Professionals. The 4th Cohort of the DST-STI policy fellowship was awarded to 15 fellows at different levels. All the policy fellows are being assigned with a defined research topic related to STI policy domain. The progress of work of the policy fellows of 3rd cohort of the PFP was evaluated and their fellowship was continued for the next. The process of inviting applications for the 5th cohort of the PFP has been initiated. The policy fellows awarded through the earlier cohorts have been doing significant contributions in the STI policy domain in the country.

1.3.3 Formulation of the 5th National STI Policy

As India and the world reorient in the present context of the COVID-19 crisis, a new Science, Technology, and Innovation Policy (STIP) was initiated at this crucial juncture during mid-2020. For India to march ahead on a sustainable development pathway to include economic development, social inclusion and environmental sustainability for achieving an “Atmanirbhar Bharat”, a greater emphasis may be needed on promoting traditional knowledge systems, developing indigenous technologies and encouraging grassroots innovations. The emergence of disruptive and impactful technologies poses new challenges and simultaneously greater opportunities. The COVID-19 pandemic provided a compelling opportunity for R&D institutions, academia and industry to work in unison for sharing of purpose, synergy, collaboration and cooperation.

The new Science, Technology, and Innovation Policy aims to bring about profound changes through short-term, medium-term, and long-term mission mode projects by building a nurtured ecosystem that promotes research and innovation on the part of both individuals and organizations. It aims to foster, develop, and nurture a robust system for evidence and stakeholder-driven STI planning, information, evaluation, and policy research in India. The objective of the policy is to identify and address strengths and weaknesses of the Indian STI ecosystem to catalyse socio-economic development of the country and also make the Indian STI ecosystem globally competitive.

The new STI policy revolves around the core principles of being decentralized, evidence-informed, bottom-up, experts-driven, and inclusive. Also, it aims to bring in the concept of ‘dynamic policy’ with a robust policy governance mechanism incorporating features such as implementation strategy, periodic review, policy evaluation, feedback, and adaptation, and most importantly, a timely exit strategy for various policy instruments.

STIP 2020 policy formulation framework involved 4 detailed tracks of activities and a coordination mechanism through a centralized secretariat. The STIP 2020 secretariat is coordinated, supported, and guided by Office of PSA, NITI Aayog and DST. The formulation process, by design, envisioned as a very inclusive and participative model with intense interconnectedness among different tracks of activities.

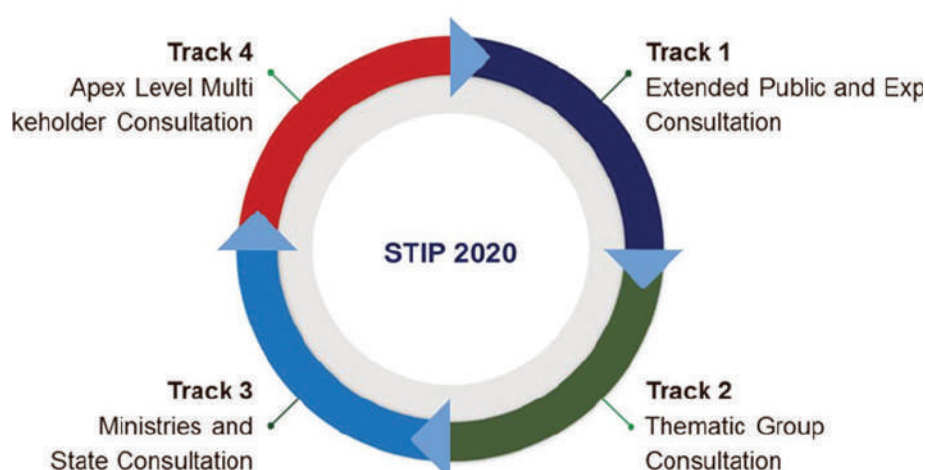

Fig. Four Interlinked Tracks of STIP 2020 Formulation Process

Track-I involved extended public and expert consultation with larger public participation. Track-I aims to capture the aspirations of a larger set of stakeholders and create a repository of public voices that will act as a guiding force for the drafting process. There are six unique activities under this track, designed carefully keeping the limitations (access, reach, digital services, language barriers and last-mile connectivity) of different stakeholder groups in mind.

Track-II had focused experts-driven thematic group consultations to feed evidence-informed recommendations into the policy drafting process. Twenty-one (21) thematic groups have been constituted for this purpose with 150+ experts drawn from government, academia, industry, civil society organizations and think tanks.

Track-III connected ministries, departments, and states to this policy process through a designated nodal officer. This track involves extensive intra-state and intra-department/ministry consultations. The 'State/UT Consultations' focused on strengthening the regional STI ecosystem and creating efficient means of STI Policy Governance at the state level that can lead to the creation of state STI Policies and action plans in tandem with the national STIP 2020.

Track-IV draws upon the apex-level multi-stakeholder engagement at the national as well as global levels. This track is ex-officio in nature, involving institutional representatives from governments, academia, industry, and civil society organizations. The Track-IV apex-level consultations have focused deliberations planned with (i) young scientists and technologists, (ii) civil society organizations with special focus on farmers and traditional businesses, (iii) scientific ministries, departments and agencies, (iv) socio-economic ministries and department, (v) state governments, and (vi) global partners.

A draft STIP policy document version has been finalized through the above detailed 4 track process of consultations beginning from May 2020. The process so far involved nearly 300

rounds of consultations with more than 40,000 stakeholders well distributed in terms of region, age, gender, education, economic status, etc. The draft STIP document is now kept for public and inter-ministerial consultation inviting comments/feedbacks

1.4 Centre for Human and organizational Research Development (CHORD)

Centre for Human and Organisational Resource Development (CHORD) division formerly National Science & Technology Management Information System (NSTMIS) continued its efforts of generating and making available information on resources both manpower as well as financial devoted to scientific and technological (S&T) activities by conducting national surveys both through in-house as well as sponsored studies.

1.4.1 S&T Resource Studies

National Survey on resources devoted to S&T activities, 2017-18 has been completed. Based on outcome of this survey, the new publications “Research and Development Statistics, 2019-20”, along with the abridged version “R&D Statistics at a Glance 2019-20”, and “S&T Indicators Tables, 2019-20” were brought out. These publication serves an evidence base for the policy formulation in the S&T sector. Further, the latest set of S&T indicators thus developed is provided as a country input for the forthcoming UNESCO S&T Statistics and the Global Innovation Index reports. The salient findings of this survey are:

- The Gross expenditure on R&D (GERD) in the country has been consistently increasing over the years and has nearly tripled from Rs. 39,437.77 crore in 2007- 08 to Rs. 1,13,825.03 crore in 2017-18. It is estimated to be Rs. 1,23,847.70 crore in 2018-19.

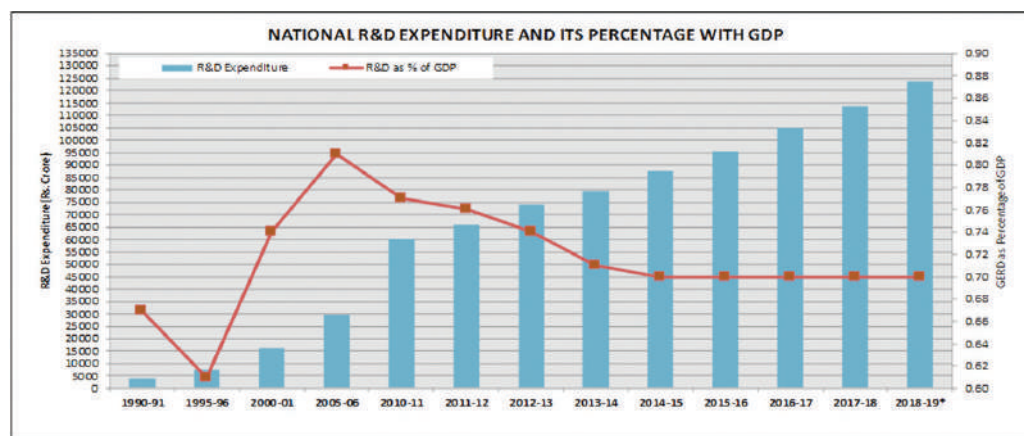

Source: NSTMIS, Department of Science & Technology, Government of India.

- India's GERD as percentage of GDP remained at 0.7% during the years 2017-18 and 2018-19 respectively.
- India's Gross Expenditure on R&D (GERD) increased to 63.2 billion PPP \$ in 2017-18 from 50.3 billion PPP\$ in 2014-15. It is estimated to be 68.8 billion PPP\$ in 2018-19.

- India accounted for 2.9% share in World GERD during 2017-18.
- World GERD increased to 2192.38 billion PPP\$ in 2017-18 from 1859.13 billion PPP\$ in 2014-15 . It is estimated to be 2323.92 billion PPP\$ in 2018-19.

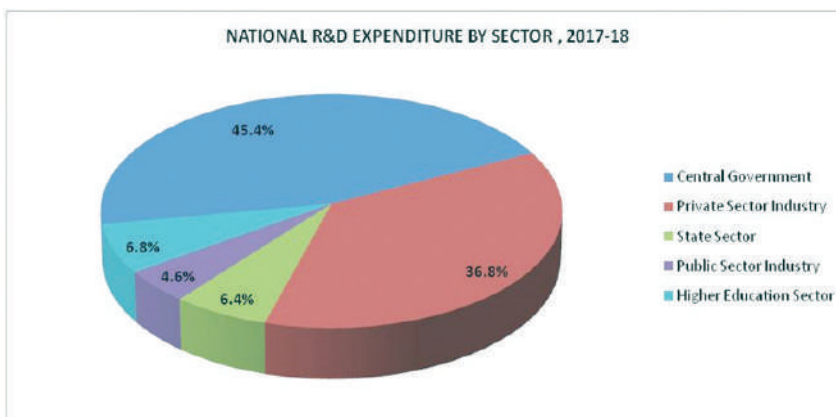

Source: NSTMIS, Department of Science & Technology, Government of India

- Gross Expenditure on R&D (GERD) is mainly driven by the Government sector comprising of Central Government 45.4%, State Governments 6.4 %, Higher Education 6.8% and Public Sector Industry 4.6% with Private Sector Industry contributing 36.8% during 2017-18.
- During the year 2017-18, 93% of the R&D expenditure incurred by Central Government sources came from 12 major scientific agencies.

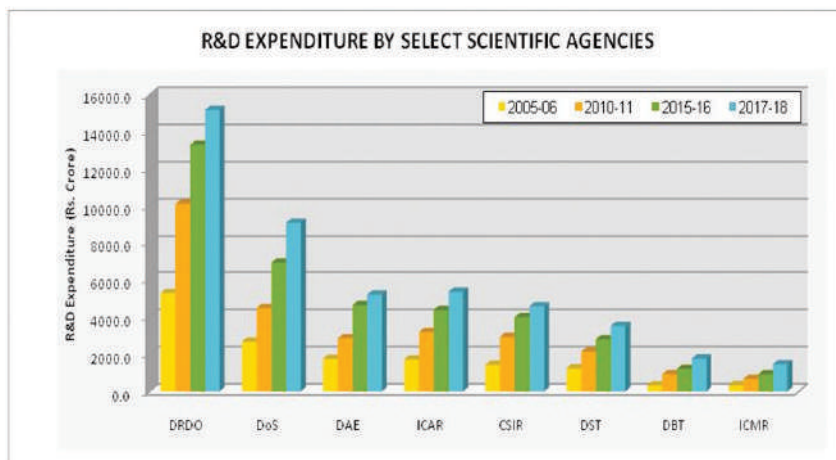

Source: NSTMIS, Department of Science & Technology, Government of India.

- Amongst the 12 Central Government major scientific agencies, DRDO accounted for the maximum share of 31.6% of R&D expenditure followed by DOS (19.0%), ICAR (11.1%), DAE (10.8%), CSIR (9.5%) and DST (7.3%), DBT (3.7%) and ICMR (3.1%), MoES (2.3%), MEITY (0.8%), MoEFCC (0.5%), MNRE (0.1%) during 2017-18.

- India stands in contrast with select developed and emerging economies with nearly 60% participation in GERD being made by the government including Higher Education Sector. Though participation of Higher Education Sector in GERD by India is quite low among the select countries.

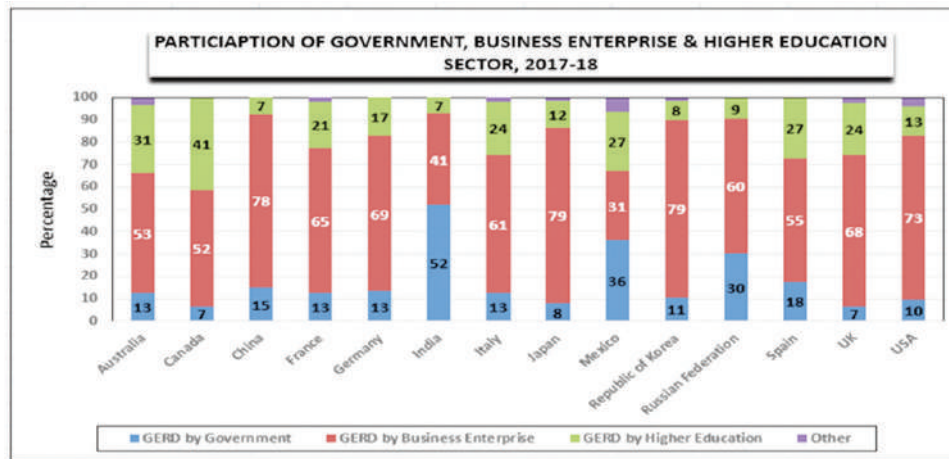

Source: NSTMIS, Department of Science & Technology, Government of India.

- In most of the developed and emerging economies, the participation of Business Enterprises in GERD is generally more than 50%. In fact it is more than 70% for China, Japan, Korea and USA.
- During 2018, India was ranked at 3rd, 5th and 9th in scientific publication output as per the NSF, Scopus and SCI database respectively. It is primarily due to varying methodological choices adopted by different citation databases. India is ranked ahead of many developed and developing countries including BRICS except China.

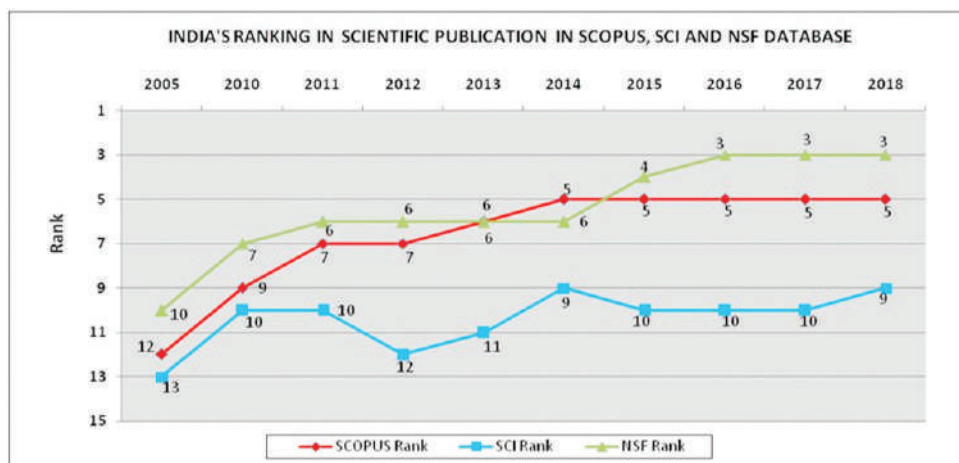

Source: NSTMIS, DST Commissioned Study (SCI ; SCOPUS Database), 2019 and NSF database, Science and Engineering Indicators, 2020

- A survey entitled 'India Innovation and Systems Survey 2019' in collaboration with UNIDO, Austria is in progress. The survey attempts at understanding innovation from the systems perspective. It aims to develop innovation indicators so as to understand the role of innovation and knowledge creation activities with the growth and benchmark the performance of the national innovation system. Five meetings of the Technical Advisory Committee (TAC) were held pertaining to selection of sectors/ industries for the system of innovation surveys and the dimensions of the firm level innovation survey, finalization questionnaires, population of the survey, sampling frame and size, data collection approach and flash survey approaches to validate the survey questionnaire.

1.4.2 Index Monitoring Cell (IMC)

Division has been assigned the responsibility of IMC, DST to provide inputs on latest S&T Indicators - for the global indices such as "Monitoring of Network Readiness Index" and "Global Competitiveness Index" being coordinated by Cabinet Secretariat, NITI Aayog, Department of Telecommunication, etc.

S&T Policy

The Division has framed two Draft Policy Documents: **Scientific Social Responsibility (SSR) and Scientific Research Infrastructure Sharing Maintenance and Networks (SRIMAN) and** after detailed deliberations with experts and stakeholders in the S&T sector.

SSR Policy primarily involves the ethical obligation of knowledge workers in all fields of science and technology to voluntarily contribute their knowledge and resources to the widest spectrum of stakeholders in society, in a spirit of service and conscious reciprocity. **SSR Policy 2020** has been approved by the Empowered Technology Group (ETG) and the Cabinet Note on SSR Policy 2020 has been sent for approval of the Cabinet.

SRIMAN policy primarily focuses on access and sharing apart from addressing issues such as procurement, maintenance, disposal, capacity building etc., for effective utilization of public research infrastructure in all scientific departments and research organizations in the country. Presently, the policy is under advance stage of approval process.

Information System/Database Activities

With a view to disseminate information on sponsored research and development (R&D) projects for the benefit of different stakeholders, NSTMIS since 1990-91, has been continuously engaged in compiling information on extramural R&D projects funded by various central S&T agencies and publishing an annual **Directory of Extramural R&D Projects**. The latest directories "**Directory of Extramural R&D Projects**" for the years **2017-18 and 2018-19** is under advance stage of compilation and printing.

NSTMIS Sponsored Studies

As a part of its outreach research programme, NSTMIS has sponsored several research

studies/projects to various stakeholders' viz. research institutions, universities, colleges, NGOs and consultancy organizations spread across the country.

The **Program Advisory Committee (PAC)** of experts for implementation of NSTMIS Scheme met during the year to review the progress of on-going projects and recommended 7 new projects related to core activities of the NSTMIS scheme. Further, meeting of Expert Committee on Bibliometrics (ECB) was held to review the progress of ongoing projects in the area of bibliometrics. At present, there are more than 70 on-going projects in the scheme. List of select projects approved by the PAC for support were in areas as below:

- Bibliometric Analysis of Global and Indian Contribution in Pharmaceutical Research
- Study of Stimulating Research in Indian Universities for Socio-Economic Development in India
- Assessment of Demand and Supply Pattern of Industry Human Capital in Agribusiness Sectors
- A study on Emerging Technology Adoption for Sustainable Agriculture in India during 2015-2019
- Design and Development of Centralized Database on Scholarship / Fellowships awarded in S&T Sector
- Impact Assessment of the Mega Food Park Scheme of Ministry of Food Processing Industries
- Study of meeting the demand and supply of quality electronic engineers in Technical field
- A study of innovation performance of Technology Incubation Centres located across Technical Institute of Karnataka
- To study the career aspirations of rural Engg. Graduates & its fulfillment extent of entrepreneurship and the impact of socio economic growth of rural hamlets of Rayalaseema Region
- Characterizing the scope, opportunities challenges & future trends in Technology Entrepreneurship Education in India

Some of the select sponsored studies completed during the year were:

- A Comparative Study of India's Research Performance in Scientific and Technology Areas of Clean Energy and Water (2007-16): A Scientometric Analysis
- Exploratory study on linkages between Technology and Trade.

- Evaluation of Impact of DST-FIST Programme
- Assessment of Gender Mainstreaming Programs for Women in Science

The completed project reports/studies are available in public domain through a **web-based digital repository** (<http://www.nstmis-dst.org/NSTDRepository.aspx>).

1.4.3 International Collaboration

The Department actively participates and contribute in the UNESCO Institutes of Statistics (UIS) and Organization for Economic Cooperation and Development (OECD) meetings for the development and revision of standards/concepts/definitions used for collection of Science Statistics and development of Science, Technology and Innovation Indicators. The department also provided information for the country on Science & Technology Indicators to UNESCO Institute for Statistics for the Global database on S&T Indicators and other related publications such as UNESCO Science Report etc.

1.5 Training Of Scientists and Technologists Working In Government Sector

Department of Science & Technology, in consultation with DoPT, other Scientific Departments and various organizations initiated an ambitious project of Human Resource Development namely “National Programme for Training of Scientists & Technologists working in Government Sector” for scientific and technical personnel during the X Plan to meet the challenges of national development and international competitiveness in S&T area. Considering the efficacy of the Scheme, the Department decided to continue it in the XI, XII Plan and for financial years 2017-18, 2018-19, 2019-20 & 2020-21 as well. Training imparted to Scientists & Technologists strives to achieve better understanding of professional requirements, enhancing professional knowledge and skills needed for better performance of individuals and organizations in the profession of science and technology, creating awareness of latest technological, economic and social developments and infusion of scientific temper in the society, generating responsiveness to the challenging needs of the democratic system and expectations of the citizens from the scientific and technological developments, providing structured forum for peer to peer interaction, experience sharing and exchange of views among the scientific community for better networking and synergy.

Target groups for the training are “Scientists/ Technologists holding scientific posts/ working in scientific ministries/ departments of Govt. of India and State Governments, Autonomous Institutions/ Public Sector Undertakings of Central/State Governments, Research and Development Institutions/ Research Laboratories of Central/ State Governments, Central/ State Universities, State Science & Technology Councils.” In view of the COVID-19 pandemic, 38 online training programmes were approved under this scheme during 2020- 21. About 850 scientists will benefit from these training programmes.

1.6 KIRAN

KIRAN (Knowledge Involvement in Research Advancement through Nurturing) embraces women-exclusive schemes of DST with the mandate to bring gender parity in S&T through various mechanisms. KIRAN is a holistic approach which addresses various challenges faced by women scientists in STEM education and career. KIRAN is expanding its wings and supporting women from all walks of life to build their career in STEM fields. The new initiatives under KIRAN are further strengthening the objectives of this scheme and started support from the young age through 'Vigyan Jyoti' and also started mentoring of institutions for transforming them towards more inclusive and sensitive approach through 'GATI'. Vigyan Jyoti and GATI are the main highlights of KIRAN for 2020-21 which are expected to be milestone in the journey towards equality. The achievements of various programs under KIRAN during the year 2020-21 are as follows:

Vigyan Jyoti

Giving emphasis on the Sustainable Development Goal of Gender Equality, it was impressed upon by the Government of India to envisage "National Transformation and Global Leadership through S&T Jobs and Opportunities". Thus, with a view to address under representation of women in Science Technology Engineering and Mathematics (STEM) in the country, Department of Science & Technology introduced new scheme under the name Vigyan Jyoti. As a first step, the scheme is targeted to initiate valuable interventions at school level for meritorious girl students, particularly from Class IX to Class XII, in order to enchant, engage, enrich, encourage and empower them to qualify and pursue STEM courses in reputed institutes in India specially fields where women are underrepresented. The scheme was officially launched on the occasion of National Science Day 2020 by the Hon'ble President of India.

The scheme started in the year 2020 in association with Navodaya Vidyalaya Samiti (NVS) an autonomous institution of MHRD, having a network of Jawahar Navodaya Vidyalayas (JNVs) across the country. In the first phase 58 JNVs have been selected in different districts of the country to implement the scheme. Out of 58 districts 8 districts have predominantly tribal populations. All the 58 JNVs have been associated with relevant Knowledge Partners such as IIT, NITs, IISERs, National R&D labs, Central/State Universities so as to provide them with required scientific resources and assistance. In each district, 50 meritorious girl students of Class XI from JNV and other govt. funded schools located in vicinity to JNV were selected for year-round activities such as Student Parent Counselling, Interaction with role models, ATL workshops, Science Camps, Lectures/Special Classes, Visit to Knowledge Partner (KP)/Labs/Industries etc. Overall around 2900 girls are going to be benefited with Vigyan Jyoti interventions.



Parents Counselling



Visit to Atomic Mineral Directorate (DAE), Nagpur

Despite the pandemic and lockdown situation, during the year 2020, around 550 online special classes/lectures were conducted covering basic and complex concepts of Physics, Chemistry, Mathematics and Biology which are important to qualify entrance examinations. More than 150 lectures, from eminent scientists/role models were also organized. Further, four (4) science camps, 22 visits to KPs/Industry/Lab, seven (7) ATL workshops and 58 student parent counselling sessions were organized. To give further aid to the selected students, resource material relevant for competitive examinations has been also distributed to the students.



Distribution of Resource Material to students under Vigyan Jyoti

One notable achievement of the scheme during 2020 is its partnership with IBM India which has offered to provide additional resources under this scheme in the form of Learning Management System (LMS), bringing in role models from technology sector for interaction with participants etc. Vigyan Jyoti is further extended to 100 districts including 13 aspirational districts in second year and now it will cover students of Class IX-XII. With this expansion around 10000 meritorious girls will be enrolled under Vigyan Jyoti.

Gender Advancement for Transforming Institutions (GATI)

To improve gender parity in Science & Technology (S&T) has been a priority for the government of India as women constitute only about 16% in S & T workforce. To address this

challenge the Department has started 'Gender Advancement for Transformation Institutions (GATI)' program in pilot mode to transform institutions for more gender sensitive approach and inclusiveness with ultimate goal to improve the gender equity in S&T domain. The GATI program was launched by Hon' ble President of India on the occasion of National Science Day on February 28, 2020.

GATI aims to develop a charter, and self-assessment and accreditation framework to support gender equality in STEMM (Science, Technology, Engineering, Maths, and Medicine) in India. GATI is inspired from the Athena SWAN gender equity charter and accreditation framework operated by Advance HE, UK, since 2005 which is now adopted by several countries in the world. Under the pilot programme, around 25-30 Institutions of National importance, National Research Laboratories, Universities and other Higher Education Institutions (HEIs) will participate. DST will facilitate mentoring of selected institutions to build their capacities on GATI framework for improving gender equity at all levels

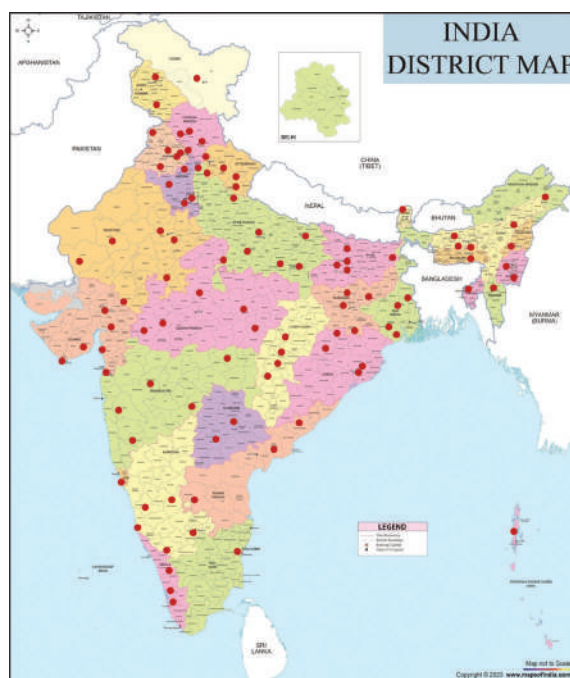

Vigyan Jyoti Scheme covering 100 Districts of 35 States/UTs

Human Resource Development

Women Scientists Scheme: WOS-A provides opportunity for research in basic and applied sciences and open throughout the year but this year submission of new proposal was suspended due to pandemic. However, proposals under WOS-B have been invited as it is once in a year call-based programme and its call for 2020 was started before pandemic. Still the call was extended till 31 May 2020 to give little ease to the applicants. Further, WOS-C call was also kept on hold due to feasibility issue.

Women Scientists Scheme-A (WOS-A) provides opportunity to women scientists who had a break in their career for research in 5 subjects (Physical & Mathematical Sciences, Chemical Sciences, Life Sciences, Earth & Atmospheric Sciences and Engineering & Technology) of basic and applied sciences. The grant has been released in around 600 ongoing projects and 122 new projects during 2020 in WOS-A. WOS-A programme has covered 28 states of the country. Women Scientists have published around 400 Research Papers in SCI Journals and 4 patents have also been filed.

Women Scientists Scheme-B (WOS-B) is fellowship for research in S&T based societal interventions. WOS-B programme encourages women scientists to analyse the challenges existing in their vicinity and provide S&T solutions to overcome these issues. They are also expected to train marginalized section of society for better livelihood generation. This year project proposals with specific location interventions addressing issues in rural/urban areas were invited from women scientists/technologists in four theme areas: Agriculture, Food and Environmental Challenges (AFEC), Health Care and Nutrition (HCN), Energy and Water & Waste Management (ER&WWM) and Engineering & IT Solutions and Artificial Intelligence (EIT&AI). Division received a total of **1107** proposals against this call. Screening process has been completed and Subject Expert Committee Meetings are being organized for final selection of society based projects/evaluation of proposals is completed in three stages. Further, release has been made in 52 ongoing projects under WOS-B.

Women Scientists Scheme-C (WOS-C), The program provides opportunity to women with mid-career break and having qualifications in S&T to pursue their career in Intellectual Property Rights (IPR). It prepares them towards self-employment by providing on-the-job training in the area of IPR. Training for the 11th batch concluded in 2020. Total of 111 women completed the 11th batch of training. Out of the total women trained in 11th batch, about 60% of the trained women scientists are actively pursuing their career in the area of IPR and are working in leading IPR attorney firms, IP departments of govt. agencies, MNCs and KPOs.

Indo-US Fellowship for Women in STEMM (WISTEMM)

WISTEMM program provides opportunities to Indian women researchers, scientists and engineers in their early or mid-career stages for international collaborative research opportunities in premier institutions of USA to enhance their research capacities and capabilities. Second batch comprising of 20 women visited leading institutions across the United States of America. Despite COVID-19 pandemic, some women had to curtail their duration but most of them were able to complete their research work.

Division has organized an interactive workshop with the second batch of WISTEMM awardees after their return to know about their experiences on both professional & personal fronts, challenges faced due to pandemic, research highlights, outcome of collaborative work, future plan carved etc.

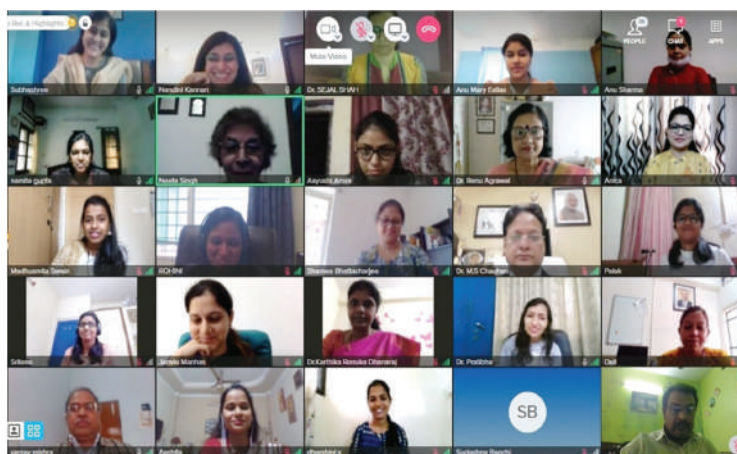

Workshop with WISTEMM Awardees

Mobility

Last year two (2) Mobility fellowships were awarded to women scientists working in Government organizations at permanent positions. Both have successfully completed their first year of research work.

S & T Infrastructure Development

CURIE (Consolidation of University Research for Innovation & Excellence in Women Universities)

Under “CURIE” (Consolidation of University Research for Innovation and Excellence in Women Universities) Nine (9) Women Universities in the country have been supported women universities for improving R&D infrastructure and establishing State-of-the art laboratories in order to create excellence in S&T domain. In 2020, CURIE support has been extended to Bhagat Phool Singh Mahila Vishwavidyalaya, Sonapat (Haryana).

CURIE-Artificial Intelligence (AI) Facility: DST has established AI lab in 6 CURIE beneficiary universities with the goal to foster AI innovations and set up AI-friendly infrastructure to prepare skilled manpower for AI-based jobs in future during 2019. All the six universities have established AI facilities in their premises and started AI based course curriculum in various UG & PG programmes. They have also started Certificate courses in AI and established Students AI club for various activities. In 2020, CURIE-AI program has supported institutions to establish high end facilities to encourage research in the AI domain. These universities are- Indira Gandhi Delhi Technical University for Women, Delhi, Avinashilingam University for Women, Coimbatore and Shri Padamavati Mahila Vishwavidyalayam, Tirupati for next phase.

Handholding meetings: A hand holding meeting was **also** conducted with the Vice-Chancellors of CURIE beneficiary Women Universities on August 26, 2020 with aim to know the progress made in establishment of Artificial Intelligence lab facilities under CURIE

programme. The VCs and CURIE Nodal Officers of five women universities have participated in this virtual meeting and made presentation.

Ease of Doing Research in COVID-19 Pandemic

The year 2020 brought several difficulties in life specially for women. The KIRAN Division has taken some special measures in pandemic era to motivate women scientists and to make their professional life easier. The interventions are as follows:

Handholding of PIs: Due to lockdown and closure of institutions, there are several queries in PI's mind about project implementation, financial obligation, release of fellowship etc. The Division took proactive mode and organized Seven (7) interactive virtual meetings under WOS-A and WOS-B programmes for handholding of PIs. Around 190 women scientists have participated in these meetings and discussed the challenges faced by them at work front. DST officials resolved several technical, administrative and financial queries of women scientists related with their projects. Apart from this, a session on how to prepare Utilization Certificate and Statement of Expenditure, Bharatkosh, PFMS and other formalities for next release of grant was also conducted in each meeting.

Grant release: DST has prioritized fellowship release as most urgent and in sync with this KIRAN Division has relaxed few formal procedures for release of grant in ongoing projects with permission of finance. Due to lockdown Institutions were closed and PI were not able to go Institutions even after lockdown period, therefore, Division has relaxed condition of duly signed Utilization Certificate and Statement of Expenditure with condition for its submission later on and released the grant on the basis of provisional Statement that also to be submitted through email only. Several hundred PIs benefitted with this relaxation and received their fellowships on time.

Project Extension: As a proactive measure Division has issued Office Memorandum for extension of duration by six months in the projects which are completing their tenure during March 2020 to December 2020 without any additional cost. The OM is available on WOS portal which can be used by PIs without any formal process as done in normal course.

Go online: Division has asked PIs to submit their documents through portal or via email and avoid surface mail to keep them safe under pandemic. The Division has also organized all the meetings at virtual platforms only. E-mail become preferred mode of communication in the pandemic time.

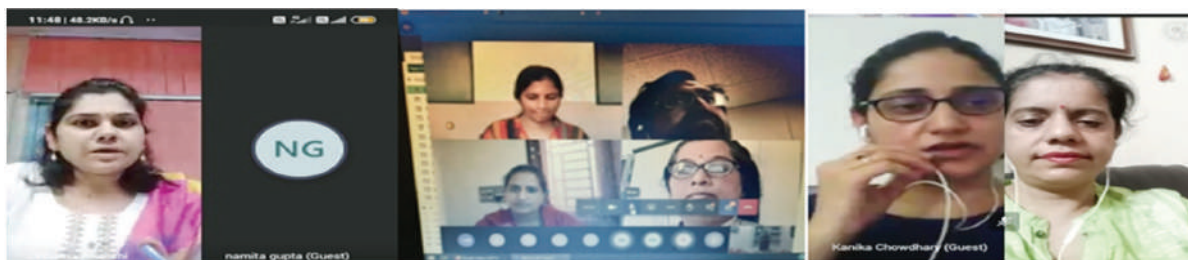

Women Scientists attending Interaction Meet

Other Activities

Workshop in R Package: Division is bound to conduct workshops/training in some new areas of research to upgrade skills of women scientists. This year a core-skill workshop has been supported 'Introductory R for Data Science' which was organized by National Institute of Plant Genome Research (NIPGR), New Delhi on December 14-17, 2020 in collaboration with University of Cambridge UK. The workshop was aimed to provide an introduction to R designed for women scientists with no programming experience and bridging the digital gender divide. The course curriculum of this workshop included how to use R and R Studio IDE and cover the basic syntax of the R programming language in order to create scripts and use functions to perform specific operations on the data; data loading from file to memory; dataframes-the most popular data structure in R; advance ways to visualize and manipulate data. More than 50 Women scientists have participated including PIs of WOS-A.

Lecture on Gender Equity in STEM: KIRAN Division has organized a lecture on 'Gender Equity in STEM: India and U.S. a comparative study on challenges and strategies for organizational change' delivered by Dr. Nandini Kannan, Executive Director, IUSSTF, New Delhi. More than 100 scientists and policymakers have participated in this lecture and learned international practices on gender equity.

1.7 INSPIRE

"Innovation in Science Pursuit for Inspired Research (INSPIRE)" Scheme of the Department of Science & Technology, GOI aims to share with youth population of the country the excitements of creative pursuit of science and attract talent to the study of science at an early stage and build the required critical human resource pool for strengthening and expanding the Science & Technology system and R&D base.

The year 2020-21 started with the Covid-19 challenge. Despite the severe disruption in official work due to lockdowns and reduced attendance, it was ensured that work related to this large-beneficiary base scheme did not suffer. Multifaceted steps have been taken to reach out to the students and research fellows to address their financial distress in the COVID-19 period. The major steps taken to provide relief during this period include:

- Fellowship for an additional six months to INSPIRE Fellows who are at their final stages of submission of their thesis, if their Ph.D. work was adversely affected because of the lockdown.
- INSPIRE Scholarship For Higher Education, and INSPIRE Fellowship timelines are extended for uploading the necessary requisite documents for award/release of scholarships/fellowships.
- During the COVID-19 pandemic, JRF to SRF up-gradation online Assessment Meetings were permitted without compromising the up-gradation norms.

- Scholarship/Fellowship was released uninterruptedly to the INSPIRE Scheme beneficiaries.
- To facilitate beneficiaries, INSPIRE Division has started an e-Helpline for addressing the issues of INSPIRE-SHE scholars. Because of the e-Helpline, e queries were answered/resolved promptly.

1.7.1 Scholarship for Higher Education (SHE)

SHE aims to enhance the rate of attachment of talented youth to undertake higher education in science intensive programs by providing scholarships and mentoring through summer attachment with leading researchers. The scheme offers 12,000 (10,000 Direct Mode + 2000 Institutional Mode) Scholarships every year @ Rs 0.80 lakh per year for undertaking Bachelor and Masters level education in natural and basic sciences for the talented youth in the age group 17-22 years. The main feature of the scheme is mentorship support to carry out research during vacation period for every scholar. During 2020-21, against direct mode 16,317 SHE scholarship applications were received and 10,190 INSPIRE scholarships have been offered to the selected candidates, based on their performance (top 1%) in class 12th examination of State/Central School Education Examination Boards and through competitive examination basis, for pursuing academics at undergraduate /integrated post graduate levels in basic and natural sciences (Figure 1). Out of the awarded/offered INSPIRE SHE scholars 45% are Female (Figure 2). Under the Direct and Institutional mode, 15332 and 3201 ongoing Scholars received their Scholarship for continuing their undergraduate /integrated post graduate degree courses in basic and natural sciences at various IIT's, IISER's, NISER's etc. respectively. Besides this 630 KVPY scholars were offered fellowship to pursue B.Sc. and M.Sc. in basic and natural sciences and 1069 KVPY scholars received their fellowship to continue to pursue B.Sc. and M.Sc. in sciences

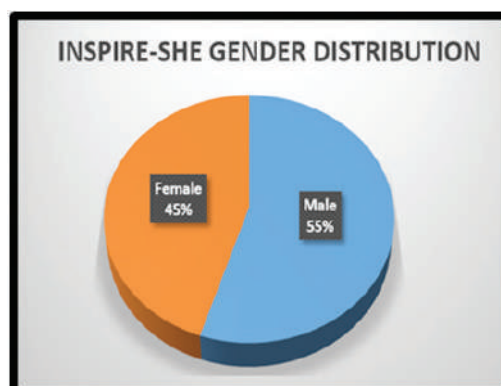
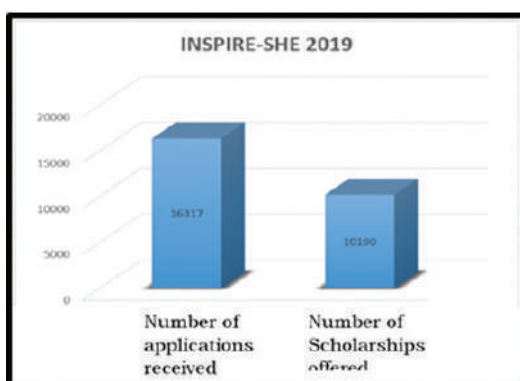

1.7.2 Opportunity for Research Careers (ORC)

ORC aims to attract, nourish and retain talented young scientific human resources for strengthening the R&D foundation and base. It has two components. The first component i.e.,

INSPIRE Fellowship, in the age group of 22-27 years, offers 1000 Fellowships every year for carrying out doctoral degrees in both basic and applied sciences including engineering and medicine. The second component i.e. INSPIRE Faculty Fellowship, in the age group of 27-32 years, offers 100 post-doctoral research fellowships for 5 years in both basic and applied sciences including engineering and medicine.

INSPIRE Fellowship: The first component of ORC is offered to students having secured 1st Rank in Basic & Applied Sciences including engineering, medicine, agriculture, veterinary at the University/ academic institute of national importance i.e. IITs, NITs, IISERs level examination as well as Inspire Scholars having secured 70% marks in aggregate at the MSc level who are eligible for admission to the PhD Program in any recognized university/ academic institutions in the country. The Fellowships are tenable maximum 5 years (2 years as JRF and 3 years as SRF) or completion of PhD, whichever is earlier to pursue full-time PhD program. The Fellowship amount including the contingencies is equivalent to CSIR-UGC NET Fellowship and is governed from time to time as per GoI norms & regulations. The Level-I result of INSPIRE Fellowship Call 2019 was announced. Out of 2017 received applications, 1739 applications were cleared for level 2 evaluation for award of INSPIRE fellowship. So far about 303 students are offered/awarded the INSPIRE Fellowship and are pursuing their Ph.D. at the university/ academic institute of national importance. Out of the awarded/offered INSPIRE Fellows 69% are female and 31% are male (Figure 3). About 26% INSPIRE Fellowship beneficiaries are SHE Scholars who have joined doctoral degree programs in science and technology after availing 5 years INSPIRE Scholarship. Three hundred and twenty-two INSPIRE fellows were promoted from Junior Research Fellowship to Senior Research Fellowship after evaluation of the research work carried out by them. Besides this, 10 INSPIRE Senior Research Fellows and 3 UK Fellows have been selected for short-term Research Internship Program at the various Laboratories/ Universities of UK and India respectively through Newton-Bhabha Ph.D. Placement Program of DST and UK. Considering the COVID-19 Pandemic, 18 INSPIRE Senior Research Fellows and 3 UK Fellows selected last year were permitted to avail the Newton-Bhabha Ph.D. Placement Program during 2021-22.

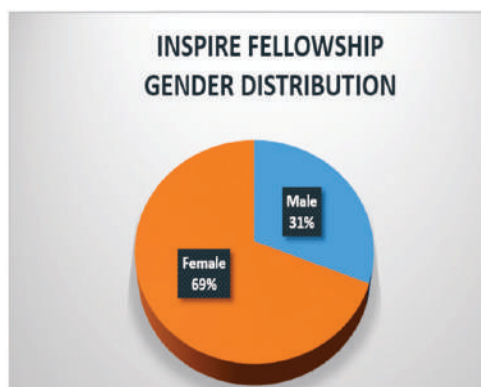

Inspire Faculty Fellowship, the second component of Opportunity for Research Careers (ORC) provides opportunities to the post- doctoral researchers in the age group of 27-32 years for 5 years INSPIRE FACULTY FELLOWSHIP in both basic and applied sciences area including engineering, agriculture, veterinary and medicine. It aims at following:

- To provide attractive opportunities to young achievers for developing independent scientific profiles and launch them in fulfilling long term careers.
- Expected to augment high quality scientific manpower for scientific and educational institutions, specially the Central and State universities.
- While the vertical migration among students in different INSPIRE components would be encouraged, the Scheme would also provide opportunity to students for lateral entry into this component.
- This component would provide an independent research opportunity and not a guarantee for position beyond 5 years.

During the year 2020,681 INSPIRE Faculty Fellows received their fellowship and are pursuing the post- doctoral research through contractual and tenure track positions for 5 years in both basic and applied science areas including engineering, agriculture, veterinary and medicine. During the year, 99 INSPIRE Faculty Fellowships were offered the fellowship (Figure 4). Out of the awarded/offered INSPIRE Faculty Fellows 23% are female and 67% are male.

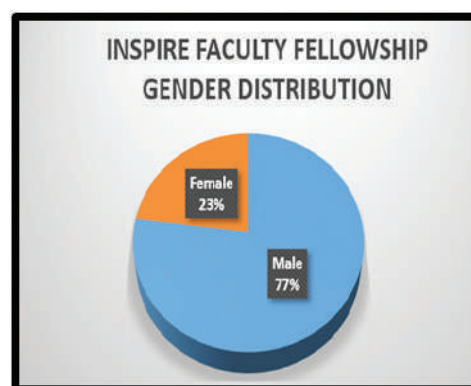
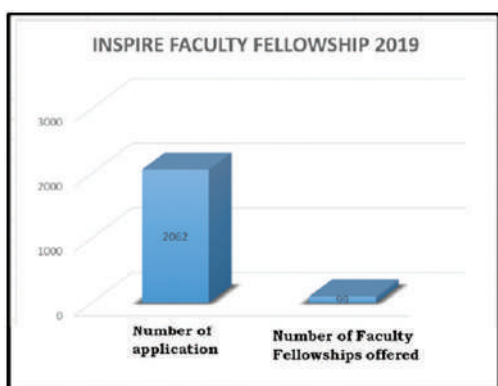

1.8 INSPIRE AWARDS - MANAK

INSPIRE AWARDS-MANAK (Million Minds Augmenting National Aspiration and Knowledge) is a national programme implemented by the Ministry of Science & Technology in which the thrust is on 'Original ideas' having potential to address societal needs through Science & Technology especially in context of National flagship Programmes such as Swachh Bharat, Digital India, Swasth Bharat, Make in India, Energy, Environment, Sanitation etc. Under the Scheme, 10 lakh ideas will be targeted from 5 lakh schools across the country every Year.

1) **Entries received under INSPIRE-MANAK 2020-21:**

COVID-19 led to a temporary interruption of day to day functioning of schools in India, who are entrusted with the responsibility to submit nominations for INSPIRE Awards – MANAK. It was absolutely necessary to be agile and find alternative solutions to maintain continuity of the flow of ideas and innovations from the schools and hence, the MANAK team came up with a proposal of conducting capacity building workshops on ideas and innovations through virtual mode. The underlying drive was year on year an eager wait that students illustrate ahead of the annual INSPIRE Awards – MANAK and therefore it is vital that the ideas which students generate after a careful and creative thought process, find a window for dissemination, as always and in no way should the pandemic come between the students and the program.

- a) The massive drive, had a huge impact on the nominations received in the year 2020-21 for INSPIRE Awards-MANAK. Received **6,53,000 entries** from 36 States & UT.
- b) The entire set of 6,53,000 ideas and innovations were reviewed and adjudicated within a period less than two months, by virtue of another IT applications and involvement of nearly 400 experts spread across different parts of the country.
- c) Processed all the received entries and **53021 entries** Shortlisted for District level from 36 States & UT and uploaded on the E-MIAS for the further processing.
- d) Throughout country about 96 percentage of Districts participated, with 50.70% girls and 49.3% boys representation.
- e) Almost all states have higher rural participation than urban.

2) **Awareness Activities under INSPIRE –MANAK 2020-21**

a) **Massive campaign on capacity building of school teachers**

The workshops featured on enriching teacher's knowledge on ideas and innovation and to develop a culture of innovation and creativity at the school level. Nearly 200 **online workshops** (8th June to 9th October, 2020) were organized as a part of awareness campaign of INSPIRE Awards-MANAK programme 2020-21, where **close to 40,000 participants** (teachers, block education officers and district education) from a majority of States and UT's in the country, including participation from difficult areas.

- b) Two State level meeting of State Nodal officers were organised for the implementation of the programme wherein the progress of aforesaid workshops were also reviewed such that more and more districts could be motivated to participate and enhance their awareness of the program.

- c) NIF collaborated with renowned Indian author Chetan Bhagat and boxing legend MC Mary Kom and disseminated their video message urging students to participate in the program, thereby strengthening the awareness campaign. The message has gain maximum leverage on Social Media (Facebook, Twitter, Instagram, WhatsApp) and it was also shared with 6.5 Lakh schools through email and SMS campaigns. Additionally, developed **three video spots** for the awareness of INSPIRE –MANAK and disseminated with all functionaries (School, Districts and States).
- d) To reach the last mile of country developed **6 radio spots (Hindi & English)** of one minute by renowned voice over artist and veteran news anchor Shri Shammi Narang for one month INSPIRE Awards-MANAK Campaign on **41 radio stations of Vividh Bharti**.
- e) Popular news channels had come forward and voluntarily urged students to participate in the annual INSPIRE Awards – MANAK program during their prime time news.

3) Organizing DLEPC/SLEPC under 2019-20:

Development of MANAK Competition APP to conduct online D/S/NLEPC

Due to COVID-19 pandemic, physical exhibition was not possible. Hence, In line with current circumstances and directions of the government to avoid public gatherings, NIF developed a user friendly APP for organising online D/SLEPC.

Online:

Organizing of online SLEPCs/DLEPCs of 2019-20. A total of one SLEPC and 4 DLEPC were conducted till 21st December 2020.

Offline:

Organizing of SLEPCs/DLEPCs of 2019-20. Total **27 State Level** Exhibition and Project Competitions (*Andhra Pradesh, Andaman Nicobar island, Arunachal Pradesh, Bihar, Chandigarh, Chhattisgarh, Daman and Diu, Dadra & Nagar haveli, Delhi, Goa, Gujarat, Jammu and Kashmir, Jharkhand, Karnataka, Kerala and Madhya Pradesh, Maharashtra, Meghalaya, Mizoram, Nagaland, Odisha, Pondicherry, Punjab, Rajasthan, Sikkim, Uttar Pradesh and Uttarakhand*) and **210 District Level** Exhibition and Project Competitions was conducted in all over country.

4) Organised Mentorship Programme for State Level Awardees of 2019-20:

Converting ideas into prototype is equally challenging. Students selected at the state levels start preparing for the NLEPC but face several challenges while converting their ideas into models/prototypes. To help develop prototypes and to showcase them in the

best possible form before the NLEPC committee, the students need consistent guidance and handholding. NIF Organised 20 mentorship programme online and offline (Offline Four + Online 16) to State Level Awardees, where about 350 students from 21 states participated.

1.9 SwarnaJayanti Fellowships Scheme

Twenty three years back, in 1997-1998 **SwarnaJayanti Fellowships Scheme** was initiated by the Government to commemorate 50th year of India's independence. Swarnajayanti Fellowship Scheme envisages providing special assistance and support to selected number of young scientists, with excellent track record aged between 30 to 40 years. The vision of this scheme is to enable outstanding Young Scientists and Faculty members to pursue research in frontier areas of science and technology. The fellowship is scientist specific and not institution specific, very selective and has close academic monitoring. The selection process is competitive and the candidates are selected through a three-tier rigorous screening process involving 6 Subject Area Committees, National Core Committee and Empowered Committee.

The support from DST includes a fellowship of Rs. 25,000/- per month in addition to the salary drawn from their parent Institution and certain amount as research grant for five years, while the project submitted by the selected Fellows is being considered for funding by the Science & Engineering Research Board (SERB) as per SERB norms, for recurring and non-recurring heads. Projects with innovative research idea and potential of making impact on R&D in the discipline are selected for funding. Scientists selected for the award are allowed to pursue unfettered research with a freedom and flexibility in terms of expenditure as approved in the research plan.

The exposure through Swarnajayanti Fellowship Scheme has enabled the Fellows in achieving higher scientific recognition. In the initial decade of the implementation of the scheme it has been observed that around 60% of the Swarnajayanti Fellows were nominated and awarded the Shanti Swarup Bhatnagar award. In the year 2020 itself out of 14 Shanti Swarup Bhatnagar awardees, 6 are Swarnajayanti fellows (**Dr. Jyotirmayee Dash-Chemical Science, Dr. Subi Jacob George- Chemical Science, Dr. Suryendu Dutta-Earth & Atmospheric Science, Dr. Amol Arvindrao Kulkarni, Engineering Science, Dr. Rajesh Ganapathy- Physical Science and Dr. Surajit Dhara- Physical Science**).

The output of each Swarnajayanti Fellow can be seen in terms of their publications (on an average 12 papers per project in reputed journals) and the number of research personnel awarded PhD with their guidance. The research papers arising out of Swarnajayanti Fellowship Scheme are often published in various International and National journals of high repute. Although many Swarnajayanti Fellows have published papers with foreign co-authors earlier, recently a fully Indian authored paper was published in Nature by Dr. Nissim Kanekar; a Swarnajayanti Fellow. Some of the awarded fellows have been successful in

filing patent for the technical process that they have developed through their project awarded under Swarnajayanti Fellowship, a few of which were commercialized as well.

Since the implementation of the scheme 206 fellows have been selected for the award of the Swarnajayanti Fellowship with the following breakup:

Sr No	Broad Area	Fellows Selected
1.	Chemical Sciences	40
2.	Earth & Atmospheric Sciences	12
3.	Engineering Sciences	42
4.	Life Sciences	43
5.	Mathematical Sciences	24
6.	Physical Sciences	45
7.	Total	206

Out of these 206 candidates, 1 candidate of Engineering Sciences who was shortlisted in 1998-99 and another candidate from Physical Sciences shortlisted in 1999-2000 did not avail the fellowship.

The following table summarizes the process of selection in each discipline in current year:

Broad Area	Applications received	Screened-in for Presentations	Selected for presentation National Core Committee (NCC)	Nominated by NCC
Chemical	39	11	4	4
Earth & Atmospheric	19	5	2	2
Engineering	94	12	4	3
Life	73	13	6	4
Mathematical	09	3	3	3
Physical	43	10	5	5
Total	277	54	24	21

The list of fellows selected for SwarnaJayanti Fellowship for the year 2019-20 is as follows:

S.No	Fellows Detail	Discipline
1.	Dr. Angshuman Nag Indian Institute of Science Education and Research-Pune	Chemical Sciences
2.	Dr. Dibyendu Das Indian Institute of Science Education and Research- Kolkata, Mohanpur	Chemical Sciences
3.	Dr. P. Anbarasan Indian Institute of Technology-Madras, Chennai	Chemical Sciences

S.No	Fellows Detail	Discipline
4.	Dr. Ekambaram Balaraman Indian Institute of Science Education and Research- Tirupati	Chemical Sciences
5.	Dr. Vijayakumar S. Nair Vikram Sarabhai Space Centre, Thiruvananthapuram	Earth & Atmospheric Sciences
6.	Dr. Sambuddha Misra Indian Institute of Science, Bengaluru	Earth & Atmospheric Sciences
7.	Dr. Suryasarathi Bose Indian Institute of Science, Bengaluru	Engineering Sciences
8.	Dr. Chandra Shekhar Sharma Indian Institute of Technology-Hyderabad,	Engineering Sciences
9.	Dr. Prabhu Rajagopal Indian Institute of Technology-Madras, Chennai	Engineering Sciences
10.	Dr. Gopaljee Jha National Institute of Plant Genome Research, Delhi	Life Sciences
11.	Dr. R. Mahalakshmi Indian Institute of Science Education and Research-Bhopal	Life Sciences
12.	Dr. Biman B. Mandal Indian Institute of Technology-Guwahati	Life Sciences
13.	Dr. Sandeep Eswarappa Indian Institute of Science, Bengaluru	Life Sciences
14.	Dr. Anup Biswas Indian Institute of Science Education and Research-Pune	Mathematical Sciences
15.	Dr. Hariharan Narayanan Tata Institute of Fundamental Research, Mumbai	Mathematical Sciences
16.	Dr. Mahesh Kakde Indian Institute of Science, Bengaluru	Mathematical Sciences
17.	Dr. Rajesh V. Nair Indian Institute of Technology-Ropar, Rupnagar	Physical Sciences
18.	Dr. Vanchiappan Aravindan Indian Institute of Science Education and Research-Tirupati	Physical Sciences
19.	Dr. Basudeb Dasgupta Tata Institute of Fundamental Research, Mumbai	Physical Sciences
20.	Dr. Rejish Nath Indian Institute of Science Education and Research-Pune	Physical Sciences
21.	Dr. Sanjib Kumar Agarwalla Institute of Physics, Bhubaneswar	Physical Sciences

RESEARCH & DEVELOPMENT

2.1 International Cooperation Division (ICD)

Salient Activities during the Year

Indicative trends in fostering international bilateral cooperation and partnerships during 2020-21 have been as follows:

- Active bilateral S&T programs of cooperation with more than 46 countries including dedicated program for Africa, ASEAN, BRICS, EU and neighboring countries;
- Dissemination of information and networking through bilateral workshops; symposiums and exhibitions;
- Facilitation of bilateral advanced schools and training programs including participation of young student researchers in international meets;
- Bilateral, multilateral and regional R&D joint projects including multi-institutional networked projects;
- Industrial and applied R&D projects involving industry participation with Canada, Finland, France, Germany, Israel, Italy, Russia, Spain, South Korea, Sweden and USA;
- Co-investment of resources including funds for symmetric joint research projects and strategic joint initiatives with Australia, Israel, Japan, Portugal, Russia and United Kingdom.
- Execution of Africa-India S&T Initiative Program through strengthening of African Centers of Excellence in select scientific areas by twinning with Indian institutes.
- Promotion of Technology Acceleration and Commercialization through India-Ethiopia Innovation program.
- Support to bi-national S&T Centres under institutional framework- Indo-French Centre for Promotion of Advanced Research, Indo-German S&T Centre, and Indo-U.S. S&T Forum;
- Mobility through research fellowships and visitation programs for Indian and foreign young scientists and researchers (HOPE Meeting; Lindau Nobel Laureates meetings; Fellowship & Internship programs with Australia, France, Germany, S. Korea, UK & USA;
- Implementation of India Science & Research Fellowship (ISRF) for scientists from eight neighboring countries to undertake R&D work in India;

- Proactive engagement and participation in international advanced research facilities like FAIR and DESY in Germany, Indian beam-line facility at KEK Japan, CERN in Geneva, Elettra in Italy, and Rutherford Appleton Lab in UK.
- International partnerships for joint research and technology development in areas of national priority through engagement with Industry Associations, like Technology Summit with CII and Global R&D Summit with FICCI.

Special COVID-19 Initiatives

Department of Science & Technology (DST) initiated process for the international scientific cooperation against COVID -19 with several countries. The joint proposals were invited in collaboration with Australia, BRICS, Croatia, Italy, Portugal, Slovenia, Serbia and the United States. Discussion on possible collaboration was made on various aspects of COVID-19 (basic science, therapeutics, diagnostics, biomedical devices, disinfectants, bioinformatics etc), following have been the developments in this regard:

- Indo-Australia COVID Call: under the AISF Round 13: The priority areas for AISRF Round 13 - COVID-19 collaborative research projects were (i) antiviral coatings, other preventive technologies, (ii) data analytics, modelling, Artificial Intelligence applications and (iii) screening and diagnostic testing. A total of 03 projects were recommended for support out of 29 received.
- BRICS COVID call: A total of 84 projects proposals were received under the BRICS COVID call in which India is a partner. India is a partner in 6 projects out of 12 recommended for support. These projects aim to develop drugs, vaccines, diagnostic kits, genome sequencing, epidemiological studies and application of artificial intelligence for treatment and prevention of COVID-19 virus.
- Indo-US Science and Technology Forum (IUSSTF) announced two new COVID-19 initiatives and the response to these calls was overwhelming with over 500 applications from bi-national teams. The two initiatives are as follows:

COVID-19 Indo-US Virtual Networks: Enabling teams of Indian and U.S. scientists and engineers currently engaged in COVID-related research to carry out joint research activities. The top 08 team teams, representing leading researchers from top Indian and U.S. Institutions, will be pursuing cutting-edge research in areas that include studies on pathogenesis and disease management in COVID-19, antiviral coatings, immune modulation, tracking SARS CoV-2 in wastewater, disease detection mechanisms, reverse genetics strategies, and drug repurposing.

COVID-19 Ignition Grants: Supporting, through the United States–India Science & Technology Endowment Fund (USISTEF), promising joint U.S.-India S&T based entrepreneurial initiatives providing innovative, out-of-the-box solutions to COVID-19 chal-

lenges. Finally¹¹ will be working on solutions that include novel early diagnostic tests, antiviral therapy, drug repurposing, ventilator research, disinfection machines, and sensor-based symptom tracking.

- A total of 98 projects received under India-Serbia, India-Slovenia, and India-Portugal joint calls are under the evaluation process.

2.1.1 International S&T Cooperation 2020-21

International Cooperation Division of the Department has the mandated responsibility of (i) negotiating, concluding and implementing Science & Technology Agreements between India and partnering countries; (ii) providing interventions on S&T aspects in international forums. This responsibility is carried out by the Division in close consultation with the Ministry of External Affairs; Indian Missions abroad; S&T Counsellors in Germany, Japan, Russia and USA; stakeholders in scientific, technological and academic institutions; sister scientific government departments; and with various industry associations in India.

Guiding Principles for International S&T Cooperation

DST is able to strategically leverage 'international collaborative advantage' by building chosen international alliances and partnerships with selected countries that can have perceptible yields, such as:

- Leverage international alliances which can value-add to national programs and missions;
- Gaining global competitiveness through bilateral collaboration;
- Accelerate institutional and human capacity building through international exposure and linkages;
- Connect Indian research with global efforts in frontier areas of S&T and in addressing global challenges;
- Participation and access to mega-science projects and international advanced research facilities;
- Promote eco-system of innovation and techno-entrepreneurship through collaboration with countries high on innovative index to provide value addition to various national initiatives;
- Adoption of new paradigms of innovative practices by developed and emerging economies in the Indian ecosystem;
- Enable applied and industrial R&D through industry-academia connect program aimed at creating new IP, process, proto-types or products;

- Connect Indian innovation model to gain access to markets in developing countries;
- Use soft prowess of S&T to build and develop bilateral relationship and people-to- people contact through capacity building and fellowship programs.

Spectrum of Cooperative Activities undertaken

During the year, DST undertook a spectrum of international cooperative activities such as: (i) bilateral S&T Joint Committee Meetings and ministerial missions; (ii) bilateral and international workshops, webinars and symposiums; (iii) joint research projects; (iv) multi-institutional networked R&D projects; (v) establishing virtual joint laboratories; (vi) training programs; (vii) access to advanced research facilities abroad & participation in international mega-science projects; (viii) continue support to bi-national S&T bodies; (ix) fellowships and visitation programs for both Indian and foreign researchers; (x) participation of young student researchers in international meets; (xi) promoting academia-industry partnerships for industrial R&D on bilateral level; and (xii) Technology and R&D summits, technology fairs, S&T exhibitions.

New Programme of Cooperation

Renewal of India-European Union Agreement on Scientific and Technological Cooperation for next five years (2020-2025)

India and European Union have renewed its Agreement on Scientific and Technological Cooperation for next five years (2020-2025) by exchange of Note Verbale between two sides. In the last 5 years, the level of co-investment on India-EU Research Technology Development Projects for addressing societal challenges such as affordable healthcare, water, energy, food & nutrition has been stepped up resulted in several technologies, patents development, their gainful utilization, joint research publications, sharing of research facility and, exchange of scientists and students from both sides.

Programs of Cooperation in Science, Technology and Innovation were concluded with Brazil, Mexico and Slovenia. These documents provided an opportunity to develop cooperation in identified themes in a given period.

Joint S&T Committee/ Council Meetings were held with Belgium, Belarus, Finland, Germany, Hungary, Japan, Korea, Russia, ASEAN, BRICS, and EU during Year 2020-2021 to review ongoing cooperation as well as to explore new cooperation in the emerging areas of Science & Technology (S&T) like cold chain technologies, 5 G, quantum computing and fostering the cooperation by involving, academia, industries and start-ups besides review of the ongoing cooperation.

Joint projects/Joint Workshop/ Seminars

The virtual webinars/conferences/workshops/ seminars were organized in the field of wind

energy, smart grid, genomic sequencing, biodiversity and traditional knowledge, epidemiology and mathematical modelling of the COVID-19, Cyber-physical systems, cyber security, quantum technologies, artificial intelligence, green economy, sustainable development, health sciences, advanced manufacturing, design, aerospace, water resources, integrated water resource management, Transport Innovation and Safety, Circular Economy on various Waste to Resource, groundwater management, technology transfer and intellectual property rights (IPR), governance management and institutional arrangements, celebration of the International day of older persons, and traditional knowledge with various countries like Belgium, Chile, Germany, Iran, Italy, Japan, Mexico, Peru, Russia, Spain, Sweden, UK, ASEAN and BRICS countries. Approximate 150 eminent speakers from prominent Indian and abroad institutes/ universities and more than 1000 participants have attended these events.

2.1.2 Bilateral Research Projects and Programs

Africa

Department of Science and Technology is working with World Bank to strengthen Africa's Centers of Excellence (ACEs) established by the World Bank in various countries of Africa using regional perspective. The ACEs are in the broad areas of Science, Technology, Engineering and Mathematics (STEM) including Agricultural and Health Sciences under a project funding format. India was one of the first countries to collaborate with these ACEs as a knowledge provider through twinning mode with selected IITs and national laboratories. About 8 joint virtual workshops were conducted in select research areas.

Australia

Under Australia India Strategic Research Fund (AISRF) – Round 12, three projects were recommended for support in the areas of food processing; storage & distribution; and climate change mitigation and adaptation. , A total of seven technical persons have been trained, 2 patents were filed and 4 papers have been published in reputed journals under the ongoing project entitled “Large Area Opto-Electronics for Australia and India: From Materials to Advanced Devices” by IIIST Trivandrum, IIT Bombay, IIT Kanpur and JNCASR.

Austria

India – Austria cooperation primarily involves the student, faculty and researcher exchange operated by DST – Federal Ministry of Education, Science and Research (BMBWF) Austria. A joint call on multi-disciplinary subjects was launched and 29 joint projects were received for exchange visits. After the joint evaluation, 12 projects were recommended for implementation in Cell Biology, Environmental sciences, biomaterials etc.

Belgium

The 5th Meeting of India-Belgium Joint Committee on Science and Technology was held on 18th January 2021 on Astrophysics & Astronomy, Materials Science and Computer Science Geodynamics, Biological Sciences, Polar research, Marine modelling. DST and Federal Public Planning Service Science Policy (BELSPO) of Belgium reviewed outcomes of previous networking call and the themes of future calls. It was agreed to develop future collaboration in Geology, Marine/Coast's, Cybersecurity, Remote Sensing and Atmospheric Research.

Benin

DST along with MEA has been implementing the S & T cooperation initiative with Africa. This includes the institute strengthening, besides Fellowship Programme, technology transfer etc. Towards strengthening the Institute of Mathematics and Physical Sciences (IMSP) Benin, a discussion meeting was held on October 28, 2020 with IMSP and C-DAC Bangalore to initiate collaboration in Big Data Analytics, High-Performance Computing, and Operations Research.

Brazil

A new Programme of Cooperation for 2020-23 in the field of Renewable energy including low carbon technologies; Earth system sciences including ocean sciences and climate change; Innovation and entrepreneurship; Information and communications technologies; Sustainable use of biodiversity; Biotechnology and human health and Agriculture was concluded between the Department of Science and Technology (DST), and the Ministry of Science, Technology, Innovation and Communications (MCTIC).

Bulgaria

A total 16 joint India-Bulgaria projects were supported in the areas of Information and communication technologies; Materials and Material Sciences; Physics, including laser science and technology, nuclear physics, astronomy and space and technology research; Chemical Sciences o Renewable energy; Earth science, geophysics, climate studies, oceanology and environmental protection, including waste management; Biotechnology, agriculture and food technology; Healthcare, biomedical appliances, bioethics, pharmacy and traditional medicine; and Social studies related to science and technology.

Czech

Under the India-Czech bilateral Agreement on Scientific, Technical and Industrial Cooperation, a joint call was announced and received the proposals under the Work Plan for the Year 2019-2022 which was signed between the DST and the Ministry of Education, Youth and Sports (MEYS) of the Republic of Czech during the visit of Hon'ble President of India to Czech on September 7, 2018. A total of 20 high ranking joint proposals were supported out of 187 were received against this Call.

Prof. Ajay Sood, an Indian scientist is nominated for the R&D Council of the Czech Republic by the Government of India on request of the Republic of Czech.

Egypt

An India-Egypt Call for proposal was launched in Feb 2019 and 131 joint research proposals have been received. Both countries agreed to support 25 joint projects which are initiated.

Germany

Under the Indo-German programme, there are two broad categories to support student and faculty exchanges and other to have research collaborations a higher scale, both operated by DST-DAAD and DST-DFG, respectively.

A total of 63 joint projects were received under the DST-DAAD call for academic exchanges across the science and Engineering disciplines. After joint evaluation, 16 projects were recommended for support by DST and DAAD on various fields of mutual interest, viz., cancer cell therapy, Engineering materials and computer aided imaging for biomedical applications etc., for further support

DST and DFG (German Research Foundation) launched a call for basic research in Physics, Chemistry and Mathematics and received 65 joint projects. After the joint evaluation, 4 projects on Sodium-ion batteries, motivic algebraic topology, stabilized cluster assemblies for new materials etc., have been recommended for implementation.

Hungary

Under Indo-Hungarian Inter Governmental S&T Cooperation Programme, a joint call for proposals was announced by the Department of Science and Technology (DST), Ministry of Science & Technology, Government of India and National Innovation Office, Budapest (Hungary) for inviting joint research projects on the mutually agreed areas: i) Biotechnology, including agriculture and food industry ii) Information and communication technologies iii) Renewable energy and iv) Water management and water cleaning A total of 95 proposals were received against the call and 11 proposals were recommended for support for next three years. A prototype for organic pollutant degradation using ceramic fiber and activated carbon block immobilized green BiOBr/BiOI/Ag (optimized material) was developed to treat the textile water and pharmaceutical industry waste under the project entitled “Green synthesis of novel BiOX (X = Cl, Br, I) and BiOXs composites, their immobilization on activated carbon fibers/ ceramic paper and their applications as recyclable photocatalysts”. Non-woven material of varying densities from polyester and polypropylene fibers, multi-walled Carbon Nano-tubes (MWCNT) have been synthesized and characterized under the another ongoing project titled “Harnessing the robust, scalable, and highly porous nonwoven metamaterials with interface engineering aided carbon nanotubes for oil spill clean-ups”,. These have a potential to be used for oil-spill clean ups.

Israel

Under the Indian Israeli Joint Research Cooperation Programme (IIJRC)-2020-2022, a joint call was announced in the areas of (i) Advanced materials for next gen solar energy utilization and storage(ii) Quantum devices for sensing imaging and communication. A total of 08 projects were recommended for support out of the 54 received. In the project titled “Exploring bone marrow MSCs derived exosomes as a potential treatment for Diabetes Mellitus type1”, mesenchymal Stem cells and their derived exosomes have been successfully isolated and characterized for treatment of Diabetes Mellitus type1. One patent has been filed in the project titled “Dissecting autism trajectories in longitudinal electronic health records”. A family of authenticated encryption called COMET that uses 64 bit block cipher with optimum level of security was designed under the project titled “Constructions of Pseudo random functions and their applications to Cryptography”.

Japan

Under the India-Japan Cooperative Science Programme 2020-2022, a total of 20 joint research projects and 4 joint seminars were recommended for support out of 139 joint projects and joint workshops received in the areas of Physical and Chemical Systems; Fundamental Science, Engineered Materials Systems; Engineering and Processes Natural Systems; Biology and Life Sciences, Global Systems; Earth-Space, Marine, and Environment and Mathematics and Computational Science. A total of 98 projects were received for the year 2021-23. These are under evaluation process.

During Indo-Japan Joint committee meeting, new activities and science and technology cooperation programmes were proposed in the areas of Neutrino Physics & Astrophysics, Quantum Technology, Nano Technology, Hydrogen economy, India-Japan Centre for Excellence, Women in STEM and research initiative for elderly aid and for Sustainable Development Goals (SDGs).

Mexico

A Programme of Cooperation (POC) on Science and Technology for 2020-2022 was signed between the Department of Science and Technology (DST), Ministry of Science & Technology, of the Indian Republic and the National Council for Science and Technology (CONACYT), of the United Mexican States in the areas of watersheds management; Food Sovereignty; Environment; Sustainable cities; Natural risks and disasters; Sustainable and relevant housing, culturally and environmentally; Health; STEM education; Energy transition; and, interdisciplinary sciences.

Norway

Under India-Norway S&T cooperation, the projects are supported on specific themes involving research activities and scientific exchanges as recommended by Joint Committee.

A joint call was launched on Nanoscience and Technology and sub-themes, under which 58 joint projects were received. The joint evaluation between DST and RCN (Research Council, Norway) yielded 7 successful projects on Emerging nanomaterials, Stem cell laden smart Biomaterials and Alloy development for additive manufacturing etc., which are under implementation now.

Poland

An Indo-Polish Joint call for Proposals was issued by the Department of Science and Technology (DST) and Polish National Agency for Academic Exchange (NAWA), Poland for inviting joint research projects on the mutually agreed areas of i) Natural Sciences ii) Engineering and Technology iii) Medical and Health Sciences and iv) Agricultural Sciences. A total of 19 joint proposals were recommended for support out of 215 received.

Portugal

An India-Portugal S&T call was launched under a 4 million Euro India-Portugal Memorandum of Understanding (MoU) to invite joint research proposals in the areas of Biotechnology; Ocean Science & Technology; Human Health; Material Sciences including Nanotechnology; Chemical Sciences; ICT; and solutions against COVID-19. A total of approximate 450 proposals have been received and under the evaluation process.

Russia

The first DST-FASIE Call for Joint Innovation by Startups and SMEs was launched. Approximate 30 Indian and Russian companies applied on both sides for co-innovative and commercialize STI interventions for societal and economic impact in multiple directions. Online exchanges between Technology Parks on both sides were also facilitated to promote Technology Enabled solutions from both sides. The proposals received under the India-Russia Technology Assessment and Accelerated Commercialization program are under the evaluation process.

The eleventh meeting of the India-Russia Joint Working Group on cooperation in Science and Technology was organized through online platform on 17th December Co-chaired by Head-International Cooperation Division, DST and Deputy Director, Department of State Scientific and Scientific-Technical Policy of Ministry of Science and Higher Education from Russian side. Both sides discussed and finalized Roadmap for cooperation in Science, Technology and Innovation (STI) between Indian and Russia. The Working Group confirmed the necessity to create a new program of cooperation in science, technology and innovation. The sides also agreed to develop a joint plan for Bilateral activities to be undertaken in 2021-22 and to launch joint call for proposals.

South Africa

Supported 25 ongoing joint projects in the areas of indigenous knowledge systems,

Agriculture Biotechnology, Astronomy etc. An India-South Africa Joint call for proposals under the collaboration was announced in July 2019 in the area of Biotechnology, Advanced Materials including Manufacturing and Renewable Energy. In total 82 joint proposals were received against the Call. Based on scientific merit, national priority of both the countries and scientific strengths of the project coordinators, both sides have jointly agreed to support following **10** proposals.

A review workshop of India South Africa flagship Astronomy programme was organized on 12-13 January 2021 to review the outcome and plan for future activities. About 50 Astrophysicists from both sides has participated in the workshop.

Sri Lanka

A Call for new applications for Joint Research project was made. Total 193 applications are received against the call which included 179 Research proposals and 14 workshop proposals areas of Renewable Energy, Metrology, Waste Management, Robotics and ICT were received from both sides against the Joint Call for Research proposals. These proposals are under review.

India has offered S&T Fellowships (fully funded by GoI) to some select neighbouring countries. 15 Sri Lankan scientists have been awarded the fellowship in last 4 calls and 9 has availed the fellowship and 5 were expected to visit in this year. Under 6th ISRF call, out of 70 applications, 03 applications are received from Sri Lankan researchers. The ISRF applications are under review.

Sweden

Under India Sweden S&T cooperation, there are two channels operated by both countries, one with basic R&D support and other focussing on more applied research with Swedish Research Council, Swedish Ministry of Education and Research and Swedish Ministry of Enterprise and Innovation (Vinnova) respectively.

A total of 20 joint proposals were recommended for support out of 108 received on additive manufacturing, bio-inspired materials, cloud based intelligent information systems etc, Under DST-Swedish Vinnova a new programme on industrial R&D programme started this year and a joint call was launched on Smart cities, clean technology and Internet of Things and their impact, focussing on more industrial R&D. A total of 4 successful projects have been recommended for support out of 33 project received.

United Kingdom

An India-UKIERI (UK India Education & Research Initiative) call for joint workshop proposals in Cyber Physical System, Water Management, Affordable health care, Advanced Manufacturing and waste design. Based on scientific merit, national priority of both the countries and scientific strengths of the project coordinators, total 16 proposals were recommended for support out

of 92 received. Only 4 workshops (one Physical and 3 virtual) workshops are organized. Supported 54 ongoing joint research projects.

An India UK showcasing workshop is in March 2021 to review the outcome of 54 India UK research partnerships and plan for future activities.

United States

The US-India Strategic Energy Partnership Ministerial dialogue (SEP): Bilateral dialogue on DST's engagement in SEP was held on 17 July 2020 on virtual platform. It covered range of topics including Energy efficiency; energy security through oil and gas development and trade; renewable energy development; sustainable and inclusive growth promotion; advance clean energy research; and cooperation in civil nuclear energy. Secretary- DST presented the ongoing PACE-R activities (Smart Grid) and future areas of collaboration such as clean coal technology and carbon capture use and storage.

Planning & Strategy Group was formed in coordination with National Science Foundation (NSF) and DST for the G2G engagement for exploring Science and Engineering Research Collaborations in Artificial Intelligence, Smart and Connected Communities, and other Industries of the Future.

Bilateral Industrial R&D Programme:

The bilateral Industrial R&D programmes are supported by DST and implemented through Global Innovation & Technology Alliance (GITA). Presently the active bilateral programmes are with seven leading countries including Canada, Finland, Israel, Italy, Republic of Korea, Spain, Sweden and UK. The industrial innovators from the two countries are encouraged to submit an application for the development of innovative product and technologies across a host of focus sectors selected as per the societal and technological needs of both the countries. The bilateral programmes, besides enhancing the commercialisation prospects of the developed products and technologies due to a wider market reach, act as a significant and sustained source of knowledge and IP transfer to the country. Some success stories of the completed projects include – (i) Planning of Addition of Renewable And Electric Vehicles And Its Integration (PARVATI) under the India-Canada Collaborative Industrial R&D programme; (ii) Development and Clinical Evaluation of Affordable Surgical Device Based on MIMs Technology for Treating of Glaucoma in India under the India-Israel Collaborative Industrial R&D programme, (iii) Design and Development of Robotic Endotrainer, (iv) Next-Generation Robust Reconfigurable Fixed-wing UAV with Wing Morphing Concept for Ship-Deck Operations, (v) Design and Development of Autonomous Amphibious Unmanned Aerial Vehicle and UAV Mountable Water Sampling Devices for Water Based Applications, under India-Republic of Korea Joint Applied R&D Programme; and (vi) Efficient Planning And Scheduling Of Rapid Bus Transportation under India-Spain Programme of Co-Operation on Industrial R&D.

India-Israel Industrial R&D And Technological Innovation Fund (I4F) : The India-Israel Industrial R&D and Technological Innovation Fund (I4F) is a cooperation platform between the Department of Science and Technology (DST), Government of India, and the Israel Innovation Authority (IIA), Government of Israel, to promote facilitate and support joint Industrial R&D projects between companies from India and Israel, which would lead to successful commercialization and benefit for both countries. In the three years of its operation, the programme has successfully seen the launch of six calls for proposal and nine projects have been awarded with funding support i.e. 18 companies from both the sides have leveraged the benefits of this fund to develop cutting edge technological products for the global market. The fund invites applications in sectors focusing on the respective expertise, mutual interest and societal needs of both the countries such as Energy, Water, Agriculture, ICT and Healthcare etc. One project titled Energy Efficiency in Agriculture Pumping with Smart Ground Water Management through Monitoring and Targeting Ground Water Aquifers has been completed under I4F.

The Department of Science and Technology (DST) and the Centre for the Development of Industrial Technology (Secretariat of State for Research, Development and Innovation, Ministry of Economy and Competitiveness, Spain) announced a joint R&D call in order to develop a joint mechanism to promote and fund innovation-driven research and technology development between S&T stakeholders of both countries as well as to encourage partnerships and business-led R&D&I projects in areas of mutual interest. The joint projects were invited in the areas of Food & Agro Technologies; Cleantech (Energy, Environment and Water); Manufacturing Technologies, Smart cities (Sustainable cities & Transport Networks); and Electronic Systems Design & Manufacturing (ESDM). A total of 06 proposals were received under this call and are under the evaluation process.

2.1.3 Multilateral and Regional programmes

India-ASEAN S&T Cooperation program

The 7th meeting of the ASEAN-India S&T Development Fund (AISTDF) was chaired by the Secretary, DST on 10th November 2020 to review the on-going Science, Technology and Innovation cooperation between India and ASEAN Member States. A new STI initiatives under ASEAN India S&T Cooperation, calendar of events and activities for 2021, Statement of Accounts of AISTDF for FY 2019-2020 and extension of the validity of the AISTDF till 31st March 2025 were approved during the meeting.

The ASEAN-India Innovation Platform (Idea to solution) for developing databanks of available technologies & Innovations for pooling and sharing among ASEAN MS and India have been launched. Information on 7079 abandoned patents had also been uploaded in Social Innovation databank and about 33 Indian Innovations have been mapped which could have potential for deployment in ASEAN Member States. About 200 innovations from India have been uploaded at Research Innovation databank. There have been contributions from

Brunei (25), Malaysia (5), Philippines (2), Singapore (6), Thailand (34), and Vietnam (5) at this databank. More than 350 innovations had been uploaded at product innovation databank which could be shared and commercialised in ASEAN Member States.

17 new collaborative R&D proposals out of 215 received in the abroad areas of Bio-medical devices, Food and agricultural sciences and Cyber Physical Systems and Artificial Intelligence were sanctioned for a period of 2 years duration and 47 Research and Training Fellowships were awarded to ASEAN professionals for carrying out their research work at various Indian Institutes.

Bay of Bengal Initiative for Multi Sectoral Technical & Economic Cooperation (BIMSTEC)

The text of the MoA for establishing BIMSTEC Technology Transfer Facility has been finalized for conclusion between BIMSTEC member countries (i.e., Bangladesh, Bhutan, India, Myanmar, Nepal, Sri Lanka and Thailand). The MoA is likely to be adopted in next BIMSTEC Summit in Sri Lanka in first quarter of 2021.

BRICS STI- Cooperation

Union Minister for Science & Technology Dr. Harsh Vardhan led the India during the virtual 8th BRICS Science & Technology Ministers meeting on 13th November 2020. The Indian side welcomes the participation of BRICS scientists in some of key flagship initiatives such as Cyber Physical System, and VAJRA. *BRICS STI Declaration 2020* and *Calendar of BRICS STI 2020* were adopted for the activities to be carried out under BRICS framework programme. These would include joint calls, thematic workshops, training, networking among young scientists; sharing of research infrastructures, participation in each other mega science programme etc. Hon'ble Minister highlighted India's efforts for the development of vaccine development and invited the BRICS minister to India for next meeting. India assumed the BRICS Chairmanship in January 2021.



Hon'ble S&T Minister Dr. Harsh Vardhan at 8th BRICS Minister Meeting



Secretary, DST led the India in the 10th virtual meeting of BRICS Science, Technology, and Innovation (STI) senior officials meeting on 12th November 2020. Secretary DST highlighted India's efforts in new emerging areas such as Cyber Physical System, Quantum computing technologies, national supercomputing mission, VAJRA, SERB-POWER and urged for the stronger collaboration among BRICS countries in these areas.

Russia as host, presented the progress report made under BRICS Science, Technology, and Innovation framework on behalf of all BRICS countries. This includes series of thematic workshops in the priority areas such as materials science & nanotechnology; ICT and HPC, Photonic, Ocean and Polar Sciences, Solid State Lighting, renewal energy, BRICS young scientist conclave etc. The Report on achievements in last five year (2015-2020) prepared under the BRICS STI MOU was also presented. The status report on BRICS COVID-19 call and new process to be adopted for next phase of collaboration was also presented. Further, the senior officials discussed and finalized the *BRICS STI Declaration 2020* and *Calendar of BRICS STI 2020* which was presented to 8th BRICS Science and Technology Ministers Meeting on 13th November 2020.

The 7th meeting of the BRICS Science, technology, and Innovation (STI) Steering Committee was attended by the senior officials from the BRICS countries on October 13, 2020 to discuss the agenda of the forthcoming meeting of BRICS S&T ministers and senior official meetings. The 8th BRICS S&T Ministerial meeting would be the adoption of the Moscow Declaration and BRICS STI cooperation. The committee recommended the publication of a report based on the outcomes of the last five years of STI cooperation, and development of the new framework and mechanism to deepen the BRICS collaboration.

BRICS Working Group meetings

India hosted the 3rd virtual working group meeting on Ocean and Polar Science and Technology. The main goal of the BRICS Ocean and Polar Science and Technology Working Group is to promote cooperation between BRICS member countries in the field of ocean and

polar science and enabling technologies through joint activities of government, universities, research institutions, and industry to generate new knowledge, train human capital, develop new technologies and applications, and improve public understanding of ocean and polar science.

The second BRICS Working Group meeting on 'New and Renewable Energy Sources and Energy Efficiency' was hosted virtually by the National Research University and the Ministry of Science and Higher Education of the Russian Federation on 14-15 October 2020. A total of forty-seven participants from all BRICS countries and speakers from selected joint scientific projects attended this meeting in the areas of new and renewable energy. Considering India's chairmanship of the BRICS next year, India offered to hold the next meeting of the BRICS Working Group on 'New and Renewable Energy Sources and Energy Efficiency' in India in 2021.

The 2nd meeting of the BRICS Working Group meeting on Nanotechnology and Material Sciences was organized online by India on October 1-2, 2020. The working group adopted the Terms of Reference (ToR) of the WG and also finalized the Concept Note for establishing the BRICS Virtual Centre on Nanotechnology and Materials Science. The WG also identified the priority areas in Nanotechnology for inclusion in the next BRICS call for proposals.

Indian experts attended the 2nd meeting of the BRICS Working Group meeting on 'Photonics' that was organized in virtual mode by Russia in October 2020. The working group finalized the Concept Note for establishing the BRICS Virtual Institute on Photonic (VIP). The WG also identified the priority areas in Photonics for inclusion in the next BRICS call for proposals.

India attended the 4th meeting of the BRICS Working Group on 'High Performance Computing (HPC) and ICT' that was organized in virtual mode by Russia in September 2020. The working group reviewed the progress of the on-going BRICS collaborative R&D projects and identified new areas of cooperation among BRICS countries in the areas of HPC and ICT. The WG also discussed the Concept Note for establishing an integrated Hub on HPC as BRICS facility for common use.

India participated and attended the 4th meeting of the BRICS Working Group on 'Science, Technology, Innovation Entrepreneurship Partnership' (STIEP) that was organized in virtual mode by Russia in October 2020. The working group discussed the mode and mechanisms for creation of BRICS Technology Transfer Centre and also networking of Technology Business Incubators of BRICS countries.

European Union

India-EU online workshop on wastewater treatment, reuse, and demonstrations of latest state of art affordable technologies in the Indian field conditions was held on 25-26 September 2020. The workshop was organized under one of the India-EU water projects supported by the Department of Science & Technology (DST) and the European Commission. In this

project, 25 research agencies are drawn from academic institutions, SMEs, NGO, civic bodies from India and Europe are working together. A total of 14 pilot plants for wastewater treatment including emerging pollutants, water harvesting for groundwater recharge have been envisaged under the project. More than 150 researchers; representatives from the industry; end-user like civic bodies, NGO; DST officials participated in these workshops.

Four India-EU research and deployment projects (PAVITR, LOTUS, PANIWATER, SARASWATI 2.0) were implemented. These projects are targeting the design, development, and deployment of wastewater treatment technologies suitable to Indian conditions. One of the projects is working on the development of a sensor for real-time water quality monitoring in the pipe distribution system and tanker water supply. About 30 demonstration pilot plants are being established across the country to test the feasibility of several technologies such as MBR, SBR, UASB, Constructed Wetland etc. The project consortium involves 130 top research organizations from Europe and India (IIT Bombay, IIT Madras, IIT Roorkee, IIT Kharagpur, AMU, CSIR-NEERI, etc.) industries, small and medium enterprises, NGOs, and other civic bodies from Europe and India. Directorate General of Research and Innovation of European Commission and DST are the implementing agency.

A mid-term review of four India-EU water projects was done on 9 November 2020 to assess the progress made. The joint review was done by the Experts nominated by India and the European Union. The overall scientific progress, especially concerning the design of the treatment system, was found satisfactory.

Shanghai Cooperation Organization (SCO) STI Cooperation

The Shanghai Cooperation Organisation (SCO) was founded in 2001 by Heads of States of six countries namely Russia, China, Kazakhstan, Kyrgyz Republic, Tajikistan and Uzbekistan. India was admitted as “Observer State” of SCO in 2005 and India became a full member of SCO by signing a Memorandum of Obligation (MoO) on 24th June 2017 at Tashkent, Uzbekistan. India is obliged to abide by the goals and principles of the Charter, the Articles of the Treaty as well as the International Treaties and documents adopted in the SCO framework. India is obliged to join 18 International Treaties under SCO Framework which includes Scientific and Technological cooperation.

At the fifth session of Heads of Ministries and Department of Science & Technology the SCO member-states in Moscow during 20-21 November 2019, India proposed to organize SCO Young Scientist Forum Conclave to harness creative and innovative potential of young talent. This proposal of India accepted by all SCO member states unanimously.

Human capacity building/ overseas exposure visits

SCO Young Scientists Conclave

The first-ever Shanghai Cooperation Organisation (SCO) ‘Young Scientist Conclave’ was

successfully hosted virtually by India during 24-28 November 2020. The Conclave was inaugurated by Dr. Harsh Vardhan, Union Minister for Health & Family Welfare; Science & Technology; and Earth Science. The conclave was attended by about 200 participants including 67 young scientists and students nominated from SCO member states. Twenty-two young scientists were given a certificate of appreciation for their innovative research work and innovation ideas on which they would like to work in collaboration with SCO countries. This five-day event of conclave provided opportunities to SCO young scientists to share their innovative idea and results in five thematic areas namely Agriculture and Food Processing; Sustainable energy and energy storage; Biotechnology and Bioengineering; Combating COVID-19 and Emerging Pandemics through research and innovation; Environmental Protection and Natural Resource Management.



Hon'ble S&T Minister and Mr. Vladimir Norov, Secretary General, Shanghai Cooperation Organisation during SCO young Scientists Conclave

Indian participation at 5th BRICS Young Scientists Conclave

19 Indian participants (17 young scientists and 2 young innovators) participated virtually in the 5th edition of the BRICS Young Scientist Conclave. It was organized by Russia during 21-25 September 2020. The BYS Conclave covered the three thematic topics: Ecology, Material Science and Artificial Intelligence. The “Science Stand-up Battle” was a video presentation of the research work of participants of BRICS Young Scientists Conclave-2020. Indian Young researchers won the 1st and 2nd positions in the “Science Stand-up battle” competition organized during the BYSC-2020

Research Training Fellowship for Developing Countries Scientists (RTF-DCS)

Fifty-four Fellowships were awarded to researchers from developing countries in various fields of Science & Technology. These Fellows from developing countries got attached to Indian research Institutes/Universities/Laboratories for carrying out their research work for a period of 6 months. All areas of Science, Technology and Engineering are covered under the scheme.

India Science & Research Fellowship (ISRF)

ISRF programme has provided opportunity to the young researchers from neighboring countries to get access to the state of art facilities available in the Indian institutes/universities. About 128 fellows from 8 countries has been awarded fellowship under this programme, about 103 fellows have availed the fellowship since 2015. 20 research papers were published during the ISRF calls from 2015-2019 and fellows also participated in various conferences/symposiums of their relevant fields. 70 applications on various research areas such as Life Sciences, Veterinary Science, Fisheries, Medicine, Dental Medicine periodontology, Agriculture, Geology, Chemistry, Mathematics, Physics, Computer Science, and Engineering etc are under consideration which would be implemented following lifting of travel restrictions.

Participation of Indian students in 70th Nobel laureates meeting in Lindau

The Department of Science and Technology and Lindau Foundation Germany have been engaged in cooperation for participation of talented Indian students in the Nobel laureates' meetings held every year in Lindau, Germany since 2001 onwards. The Nobel laureates' meetings are organized on Physics, Chemistry, Physiology, Medicine and Inter-disciplinary sciences. One discipline is chosen each year. Around 600 students from nearly 80 countries are attending and interacting with 40 Nobel laureates every year.

The 70th Anniversary meeting of the Nobel Laureates was planned for June, 2020. DST and Lindau have jointly selected 30 meritorious students in Interdisciplinary areas of Physics, Chemistry and Medicine, out of 270 applications received. However, the Meetings in June 2020 could not be held due to prevailing pandemic. The selected students for the year 2020 would be considered for 2021 meeting, scheduled to be held during 27 June to 2nd July 2021.

Ramanujan Prize 2020

The ICTP Ramanujan Prize of US\$ 15000 for Mathematics for the year 2020 was bestowed to a female researcher, Prof. Carolina Araujo, the Institute for Pure and Applied Mathematics (IMPA) in Rio de Janeiro, Brazil. The award was conferred by the International Centre for Theoretical Physics (ICTP), Trieste, Italy on 09 December 2020 in the virtual presence of Secretary DST, Indian Ambassadors to UNESCO and Italy. The award is a recognition of her work and contribution in the field of Algebraic Geometry. Prof. Araujo has also played a key role in promoting women in mathematics and in the organization of important mathematical activities.

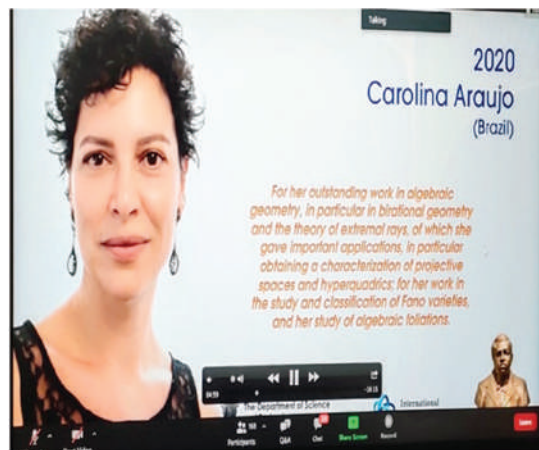

Other Engagements

Industry Academia Conclave

9th Foundation Day of Global Innovation & Technology Alliance (GITA) was held virtually on 26th November 2020. The theme of this year's celebration was "Atmanirbhar Bharat". Over 500 participants from India and abroad attended the event. Country sessions were organised with Israel, Sweden, Canada, and the Republic of Korea. While congratulating GITA for completing 9 years of operations Hon'ble Minister for Science & Technology, Earth Sciences mentioned that GITA has managed to carve a niche for itself serving as a catalyst for fostering innovation, generating awareness and interest in the industry to enable them to benefit from various Government funds being managed by GITA. Prof K Vijay Raghavan Principal Scientific Adviser to Govt of India and Prof. Ashutosh Sharma, Secretary, DST also addressed the participants. Three successful completed bilateral projects under India-Korea Programme, India-UL Programme and India-Canada Programme were felicitated on the Foundation Day.

Technology Summit

Dr. Harsh Vardhan, Union Minister of Science & Technology, Health and Family Welfare and Earth Sciences, Government of India, and Prof. Manuel Heitor, Minister of Science, Technology and Higher Education, Government of Portugal, addressed the inaugural session of the summit on 7th December 2020 in which the focus sectors were water-tech, agri-tech, health-tech, energy, climate change, cleantech, ICT, advanced technologies, and space-ocean interactions. Dr. Harsh Vardhan also inaugurated the high-technology digital exhibition on 7th December 2020 as part of the summit. The three days summit was attended by 2,200 delegates (200 from Portugal, 2000 from India & 64 from other countries) and had 85 speakers. Around 49 Indian industries and 11 Portugal industries showcased their technology in areas like water, health, energy, cleantech, and so on at the digital exhibition. Besides, 200 B2B meetings were held to share experiences.

The DST-CII India-Portugal Tech Summit has identified several opportunities for engagement amongst stakeholders at various levels while deliberations on the possibilities of scaling up solutions to address societal challenges facing the world have yielded positive results. The three-day summit witnessed a series of engaging and productive deliberations on matters that concern the socio-economic development, not only of India and Portugal but also of the world.

Global R&D Summit

The Global R & D Summit is an annual event organized by FICCI with DST. This year's virtual Global R & D summit 2020 is organized during November 25-28, 2020 with a theme "*Building Resilient Economies through Technology and Innovation: Development Partnerships in the New World Order*". The Summit brought together 80+ technology experts from around the globe to deliberate on it. FICCI has launched in The Summit the "**Science meets Industry**" series which will bring forth innovations that can be commercialized and scaled to achieve a larger socio-economic impact.

Vaishwik Bharatiya Vaigyanik (VAIBHAV) Summit

A global summit "Vaishwik Bharatiya Vaigyanik (VAIBHAV)" was organized by DRDO in partnership with DST, MOE, CSIR and with participation of academic organisations of India from October 2-31, 2020. It was a collaborative initiative to enable deliberations on thought process, practices and R&D culture with a problem-solving approach for well-defined objectives. The VAIBHAV initiative aims to bring out the comprehensive roadmap to leverage the expertise and knowledge of global Indian researcher for solving emerging challenges.

The advisory committee meetings were held during October 28-31, 2020 where the panellists of various verticals have presented the outcomes of the discussions results under various horizontals of the certain vertical. The advisory committee has given their insights on the outcomes and asked the panellists to submit their reports for preparing the new roadmaps for miraculous changes in S&T.

Portal for Indian Diaspora named Pravasi Bharatiya Academic and Scientific Sampark "PRABHASS"

After the successful completion of the VAIBHAV summit, on 31st Oct 2020, a new portal for Indian Diaspora namely **Pravasi Bharatiya Academic and Scientific Sampark "PRABHASS"** was launched. The DST was an active member of the steering committee of Vaibhav Summit and now, is an active member of the working group of PRABHASS. The working group meetings of "PRABHASS" were held for discussing the use of the PRABHASS platform to bring India based and foreign-based S&T experts together. The brainstorming sessions of the committee took place at times to discuss and process the valuable suggestions previously given by Indian diaspora during Vaibhav Summit. This virtual platform is a way forward to bring India based and foreign based S&T experts together.

India International Science Festival-2020 (IISF-2020)

The 6th edition of the India International Science Festival (IISF), 2020 was organized virtually during 22nd- 25th December 2020.

Dr. Harsh Vardhan, Union Minister of Science & Technology, Health and Family Welfare and Earth Sciences, Government of India inaugurated the 'Science Diplomacy' event which is introduced first time in this science festival. It was organised for spreading awareness and sensitize governance and policymakers to accept the concept of science and technology in diplomacy in the mainstream and give its due importance for nation-building. This conclave also provided an orientation of the national goal for 'Aatmanirbhar Bharat' in the context of international relations.

Overseas S&T Ministers and Diplomat Conclave: A virtual overseas Science and Technology Ministers and Diplomats Conclave focussed on ASEAN & neighbouring countries was organised as a part of the virtual India International Science Festival-2020 (IISF-2020) on December 23,2020. During the Conclave Ministers from Afghanistan, Cambodia, Indonesia, Myanmar, Philippines, Sri Lanka and Uzbekistan; Diplomats from Denmark, Italy, Netherland, Switzerland; Scientists and policy makers from Russia, Thailand and other countries deliberated upon the **R & D Strategy in Post COVID Era**. The common denominators for the scientific cooperation which emerged from the Conclave included the need to address societal challenges through application of science and technology in emerging areas such as Affordable Health care including vaccine diagnostic, Climate change adaptation, Agricultural science and Artificial Intelligence.

Bi-national Centres

Indo-French Centre for Promotion of Advanced Research (IFCPAR/CEFIPRA)

The 33rd meeting of Governing Body (GB) of CEFIPRA scheduled to be held on 20 March, 2020 at New Delhi, India was concluded through virtual mode due to the pandemic. The GB approved launch of a) DST-CEFIPRA Women Post-Doctoral Fellowship (DC-WPDF) for women scientists/researchers b) CEFIPRA Outstanding Project Award/PRIX Du projet Exceptionnel (PRIDE): PRIDE- CEFIPRA Award –for Indo-French joint projects that achieved significant breakthroughs/outstanding accomplishments instituted c) Resuming the CEFIPRA- European School on Nano-sciences and Nano-technologies (ESONN) fellowship programme for Indian doctoral students (capacity building) in the areas of Nanoscience & Nano Technology) 7th Annual Lecture series of CEFIPRA(2021) :- by eminent French expert on efforts towards COVID-19 mitigation

The 65th Scientific Council and 36th Industrial Research Committee meetings of CEFIPRA were held virtually on 27 May 2020 and 29 May 2020 respectively. During the meeting of Scientific Council, a total of ten project proposals were recommended for support in the areas of AI & Big Data, Science for Sustainability, Quantum Materials, Addressing Biological

Questions Using or Developing Mathematical, Computational or Physical Approaches, Life and Health Sciences, Earth and Planetary Sciences, Materials Science and Environmental Science under Collaborative Scientific Research Programme (CSRP).

Industrial Research Committee evaluated proposals received under the Industry Academia Research & Development Programme (IARDP) from various thematic areas of Machine Learning, Oenology, Nutrition, Ophthalmology and Affordable healthcare. Three innovative projects were recommended for support. Ongoing projects were also monitored during the meeting.

During the current year, approx. 200 publications and 14 patents resulted out of the projects supported under CSRP & IARDP.

New Call under CSRP was launched with thematic areas as a) Host-Microbe interactions in Health, Water & Agriculture; b) Habitability of the Earth & Planets; c) Marine Biology and Ecology & d) Chemical & Synthetic Biology for the deadline of 15 January 2021. Thematic areas identified for industrial seminars/workshops for this year were Natural products and cosmetics, Nano toxicology and Smart and digital manufacturing.

Three seminars were held during the year, one in France and two in India. Indo-French seminar on “Goa- Atlantic cooperation programme (GOAT)” was held in Brest, France in January 2020 with a goal to establish bridges between individual academics, scientists, and engineers. In support of that an MoU was signed between IIT Goa and various French institutions from Marine Science/Oceanography. Indo-French Seminar on “Optimization, Variational Analysis & Applications” was organized by Deptt. of Mathematics, Institute of Science, BHU, Varanasi” during 2-4 February 2020 and an Indo-French Seminar on “Small molecules activation for fuels and commodity chemicals production” was organized in Indian Association for the Cultivation of Science, Kolkata.

During the year, CEFIPRA organized its 5th meeting of the Standard Expert Panel (SEP) comprised of patent attorney from India, Counsellor for Intellectual Property from French Embassy in India, Senior Principal Scientist, Innovation Protection Unit- CSIR, Industrial Research Committee Members, on 17 June 2020. SEP was set up in 2016 to mentor and monitor the Indian & French project Collaborators on Intellectual Property (IP) rights and commercial potential of their joint projects. 20 Indian and French Collaborators from CSRP & IARDP attended the 5th SEP meeting via skype. Various issues related to Intellectual Property (IP) management were addressed and Collaborators were encouraged to file more patents, whenever patentable outcome is available under their joint research programme.

The Centre continued to facilitate the ‘Targeted Programmes’ for the national funding agencies such as DST from India, INRIA and CNRS from France thereby supporting collaborative scientific research in areas of national importance & of mutual interest. These programmes cover the domains of Big Data, Computer science for Biology and Life Sciences, Artificial

Intelligence, Cyber Physical Systems etc. Currently, 22 projects were being supported (5 ongoing + 17 completed). Further, under the 7th Call for proposals, two more projects recommended for support will be initiated. Under DST-CNRS Targeted Programme, 4 projects are ongoing in areas of Biodiversity, Ecosystems and Human-environment interactions, Detector and theory developments in nuclear and particle physics & Engineering and Systems Sciences. The Expert committee meeting to review the progress of ongoing and completed projects of DST-Inria-CNRS and DST-CNRS Targeted Programmes held in January, 2021 through videoconferencing.

In order to strengthen human resource development, under the existing Raman-Charpak Fellowship-2019, 25 Indian & 1 French PhDs & 4 French Masters' students were supported to work in Indian and French laboratories. Due to lockdown and restrictions on international travel, 16 Indian PhD students stranded in France were facilitated to return to India through Vande Bharat Mission of MEA, GoI. Two French students were facilitated for an early return to France. The Debriefing Session for the Raman-Charpak Fellows of batch 2018 was virtually organized on 02 July, 2020. 15 Indian students could do their Post- Doc in France after the fellowship. Together, 90% of the students have rated their fellowship experience as 'Excellent'.

Under, Technology Development Board (TDB)'s bilateral Programme with Bpifrance managed by CEFIPRA, one project is ongoing in the area of Medical devices between Panacea Medical Technologies Pvt Ltd, Bengaluru and DOSIsoft SA, Cachan, France. The project envisages the development of IMRT/IGRT based Treatment Planning System (TPS) for 6 MV Medical LINAC and its commercialisation for making the cancer treatment cost effective.

During the year it was continued to publish CEFIPRA newsletter "Ensemble" giving glimpses of activities of the Centre and 3 success stories of projects were published by Vigyan prasara on various media platforms.

The Indo-German Science & Technology Centre (IGSTC)

IGSTC continues to accelerate the Indo-German Research network through its programmes and schemes with a zeal and play a pivotal role in facilitating the area of collaborative research supporting various Indian & German institutes and industry. The flagship scheme of 2+2 currently supports 20 projects in various areas of the national priority for India and Germany. During 2020-21, IGSTC supported 20 joint projects in 2+2 mode in emerging areas of (i) sustainable energy (ii) advanced manufacturing (iii) biomedical devices and technology (iv) water & wastewater technologies (v) Smart Cities (vi) Sustainable Production (vii) Clean and Green technologies. Currently, ongoing IGSTC Projects involve 87 (eighty-seven) project partners from academia and industry from India and Germany with total project investment (both Indian and German) of estimated ₹ 120 Cr or € 15 million. Approximately 600 scientists, researchers, engineers from both countries are networked through this programme from its inception. Also, 250 research personnel at the level of post-doctoral, doctoral, masters and

bachelors are working on these projects creating capacity building of high-quality research manpower significantly.

For the recent IGSTC 2+2 Call 2019 in the overall thematic area of Bioeconomy with subtopics Future agricultural farming, Logistics in agriculture supply chain, Technologies for sustainable and improved agricultural production, 4 projects are recommended for funding.

Multi-WAP project partnered by IIT Madras, Chembiosens Pvt. Ltd., TU Braunschweig and Lionex GmbH to develop cost-effective, multiplexed label-free fiber optic array biosensor system for simultaneous detection of up to 7 or more waterborne pathogens that are prevalent in Indian sub-continent received a Phase 2 extension with funding to commercialize the successes built in Phase 1. One of the significant achievements is the development of the automated fiber bending machine to fabricate U-fiber optic probes with high consistency in the probe geometry and hence the reproducible sensitivity. One of the major success story of the projects was Incorporation of ChemBioSens Pvt. Ltd., a start-up company as a spin-off of the technology development activities at the Biosensors Laboratory at IIT Madras enabled by the IGSTC project funding on 23/10/2018 at IIT Madras Incubation Cell.

IGSTC conducted three web conferences at National Institutes of Technology (NIT) at Jalandhar and Andhra Pradesh and at Saintgits College of Engineering (Autonomous), Kerala. The web conferences focused on bilateral funding opportunities and industrial based future research collaborations. The webinar touched around 500 faculty members, research scholars and master's students. The outreach activity was primarily aimed for young faculty members to look for bilateral funding early in their research career.

IGSTC organized a virtual workshop "IGSTC Virtual Event: 2+2 Call 2020 in Additive Manufacturing" for promoting its Call 2020 on Additive Manufacturing on 12th November 2020. The event had a stellar speaker's line-up of eminent scientists from India & Germany that attracted more than 400 registrations and an active participants of around 150 people at any given time in the event.

The Indo-US Science and Technology Forum (IUSSTF)

The activities of IUSSTF are broadly grouped into four categories: (i) Scientific Networking; (ii) Innovation and Entrepreneurship; (iii) Research and Development & (iv) Visitations and Fellowships. A summary of IUSSTF's activities in 2020-21 is presented below:

Through a competitive grants program, the Fund selects and supports financially promising joint U.S.-India entrepreneurial initiatives that address the theme of "commercializing technologies for societal impact" by providing grants in two broad areas - *Healthy individuals* and *Empowering citizens*. The 10th Call for Proposals under the USISTEF Program was announced in September 2019. Following a rigorous, multi-tier, binational review process, five projects were selected for Award in October 2020.

In March 2020, IUSSTF and the U. S. Department of Energy signed a MOU to establish a framework of partnership and engagement toward the organization of a Solar Decathlon in India with the Indian Institute for Human Settlements (IIHS) and the Alliance for an Energy Efficient Economy (AEEE)-India serving as the implementation partners. In the 2020-21 challenge, 75 teams have registered from 102 academic institutions and will compete in one of the following four Divisions: Multifamily Housing, Educational Building, Office Building, and Community Resilience Shelter.

The “UI-ASSIST: U.S.-India collaborative for smart distribution System with Storage” project co-led by the Indian Institute of Technology, Kanpur and Washington State University, Pullman was awarded in September 2017 under the Indo-U.S. Joint Clean Energy Research & Development Centre program (JCERDC) Phase II. The Program, funded by the Department of Science and Technology, Government of India, and the U. S. Department of Energy, is implemented and administered by IUSSTF. This is a unique project bringing together researchers from academia, national laboratories, industry, and private companies as well as policy experts and utility regulators. An Annual Bilateral meeting was held July 21-24, 2020 to highlight the accomplishments of the UIASSIST project. The virtual meeting included workshops, a series of technical talks, an overview of the progress made under each of the 11 themes by the US and India leads, and a discussion of next steps.

Recognizing the importance of developing online ‘River Water and Air Quality Monitoring (WAQM)’ systems, the Department of Science and Technology (DST), Government of India, and Intel collaborated to initiate research in this area. *Four projects were identified for award in 2017-18* of which two were funded under ‘Air’ and ‘Water’ Quality Monitoring categories, respectively. Phase I (first three Years) of the Initiative was intended to support research across multiple vectors, integrated in a manner to develop complete technological solutions that would result in a fully functional demonstration at the test bed level. With Phase I slated to end in December 2020, the Project Monitoring Committee (PMC) met virtually to monitor the progress of the Projects in conformity with the outputs, milestones, targets and objectives, and assess the overall impact of the Projects.

The governments of the United States of America (through U.S Embassy) and India (through Ministry of New and Renewable Energy) established the Indo-U.S. PACEsetter Fund (PSF) to accelerate the commercialization of innovative off-grid clean energy access solutions by providing early-stage grant funding that would allow businesses to develop and test innovative products, business models and systems.

The Indo-US Science & Technology Forum (IUSSTF) organized a Virtual Interactive Workshop on November 9, 2020 to highlight the accomplishments of the 2nd Cohort of Awardees under the Indo-U.S. Fellowship for ‘Women In STEMM’ (WISTEMM) program supported by the Department of Science and Technology, Government of India (DST).

2.2 National Mission on Nano Science & Nano Technology

Nano Mission Program was initiated by Department of Science and Technology (DST) to foster, promote and develop all aspects of Nano Science and Nano Technology that have the potential to benefit the country technologically, in strategic areas and also for the society at large. One needs to promote Nano Technology to encash from research in this emerging area and to keep pace with developments taking place globally.

This is an umbrella Program which promotes basic research and focuses on Nano Technology adaptation and transfer to industry for use by masses. Nano Mission is continuously successful in its Phase II towards creating an ecosystem for Nano S&T research in the country. The support under Nano Mission, extends to create skilled human resources, projects related to Nano Science and Technology and building infrastructure of Nano S&T Labs at several Institutes spread across the country. The efforts of Nano Mission are evident through India's global ranking based on the publications in SCI Journals. It was 9/10th in 2001, became 6th in 2004-05, 3rd from 2013-14 and consistently holding this position thereon. The capability and capacity growth is evident from India's 16th rank in USPTO in 2016 patents. There is an unprecedented growth by 36.36% in the area of Nano S&T in number of patents granted in 2016 as compared to 2015 figures.

In recent years, Nano Mission apart from continuing basic R&D support, also changed its priority on creating suitable environment to attract technology relevant projects. This is being achieved through an active dialogue with the Industry either by co-funding partially the industry sponsored relevant projects in Nano S&T or by supporting incubators and start-ups in the area in close consultation with other Innovation Programmes in DST and other Departments/ Ministries. Also identifying feasible technologies and funding prototype development with Industrial involvement and transfer them to start-ups or collaborating industry.

The Nano Mission operates in the following verticals:

- Basic Research Promotion
- Infrastructure development for Nano S&T Research
- Nano applications and technology development
- Human Resource Development
- International Collaborations
- Nano Regulatory Aspects

The Mission is steered by the Nano Mission Council (NMC) with Bharat Ratna Professor CNR Rao as its Chairman. The Technical Programs of the Nano Mission are also being guided by two Advisory Groups, viz The Nano Science Advisory Group (NSAG) with Professor Ajay K

Sood as its Chairman and the Nano Applications and Technology Advisory Group (NATAG) with Professor V Ramgopal Rao, Director, IIT-Delhi as its Chairman.

Separate Committees comprising of Experts in the relevant areas are consulted regularly for evaluating and monitoring the supported projects twice during its implementation. Normally, the first monitoring is done after 15-18 months for a 36 months project, and 12-14 months for a 2 years project, where rating for the output is evolved and given for the progress of the project, in Nano Science and based on uniqueness of the work being done and patent filed or granted for projects in Nano Technology area.

Apart from these two Committees, Nano Mission also has a Human Resources and International Advisory Group (HR&IAG) that guides the Nano Mission in its National Post-Doctoral Fellowship Scheme and the International Collaborations for use of Synchrotron abroad. Apart from these 3 Groups, an Inter-Agency Advisory Group is also constituted to collaborate on major programmes like the NanoElectronics Networking and Research Applications (NNetRA), a major programme with M/o Electronics and IT (MeitY). Here 5 Institutions namely Indian Institute of Science-Bengaluru along with IIT-Mumbai, Kharagpur, Chennai and Delhi are being supported by MeitY, DST and the host Institutions, in the ratio of 1:1:1, with support of Rs 90.01 crore each.

The submission of projects under Nano Science or Nano Technology is done online using the e-PMS Application package of DST. Moreover, submission of projects in Nano S&T is now open throughout the year since 2019. Normally we plan to give the decision within 3-6 months on the project.

Under the Nano Mission we also organise two events every alternate year namely Nano India and an International Conference in Nano Science & Technology (ICONSAT) with the ICONSAT organised during March, 2020 just prior to the pandemic lock-down. The ICONSAT – 2020 was organized at S.N. Bose National Centre for Basic Sciences, Kolkata between March 5 – 7, 2020. From the overwhelming nominations submitted for Young and Senior Nano research awards categories, Nano Mission Council shortlisted 2 – Junior researchers and 1 – Senior for year 2020 Nano awards. The awards were given during the ICONSAT-2020 sessions. The conference had 6 Plenary lectures, 54 Invited lectures by Distinguished and Eminent International Scientists and prominent Nano Scientists from India. In addition, 340 posters presentation and 20 Industries participated and displayed their technologies. Nearly 500 participants benefited from the ICONSAT – 2020.

Nano-Science Projects (Basic Research Promotion)

Basic Research Promotion:

During the year 2020-21, we have had one meeting of the Nano Science Advisory Group (NSAG) so far, which was organized on a web based platform. In this meeting, the NSAG has recommended 2 proposals for support from a bunch of 5 proposals with positive comments..

Apart from the regular Schemes of Nano S&T, last year we had given a Special ‘Call for proposals” in three THEMATIC areas was made. These areas were:

- Nanotechnology for Agriculture – 116 proposals were received
- Nano for Energy and Environment – 199 proposals were received
- Quantum Materials with novel properties and applications – 59 proposals were Received.

During last year, the NMC in its 4th meeting on 10.03.2020, had finally recommended 3 projects each from the first 2 areas and 9 projects from the last area for support. During this year, we sanctioned financial support to the three projects in the area of Nanotechnology for Agriculture wherein part support to one of the proposals was also provided by Indian Farmers Fertiliser Cooperative Limited (IFFCO), who have set up a Centre for Research in Nanobiotechnology at Kalol in Gujarat.

The final recommendation of NMC came in June, 2020 after pursuing the presentation sent by the PI including the budget required under Capital and General head. The NMC had finally, recommended 03 proposals each for financial assistance under Nano Technology for Agriculture & Nano for Energy and Environment and 11 proposals under Quantum Materials.

Sanctions for the three proposals under Nano Technology for Agriculture has been released along with 4 proposals under Quantum Materials from reduced budget available under the Nano Mission.

Notable Achievements made in Nano-Science ongoing projects:

- Researchers from School of Biomedical Engineering, Indian Institute of Technology (IIT), Banaras Hindu University (BHU), India have invented a new Nanomedicine for the treatment of invasive ‘Triple negative breast cancer’. In this work, they have designed a unique polymeric nanomedicine with nanoscale influence, encapsulated water insoluble anticancer drugs, which can target easily to the Triple negative breast cancer and release the anticancer drugs in the physiological environment for a longer period of time. This nanomedicine is also useful for nano immune therapy, nano vaccination & for TB therapy.
- Researchers from School of Biomedical Engineering, Indian Institute of Technology(IIT), Banaras Hindu University (BHU), India have invented a new Nanomedicine for the treatment of invasive ‘Triple negative breast cancer’. In this work, they have designed a unique

polymeric nanomedicine with nanoscale influence, encapsulated water insoluble anticancer drugs, which can target easily to the Triple negative breast cancer and release the anticancer drugs in the physiological environment for a longer period of time. This nanomedicine is also useful for nano immune therapy, nano vaccination & for TB therapy

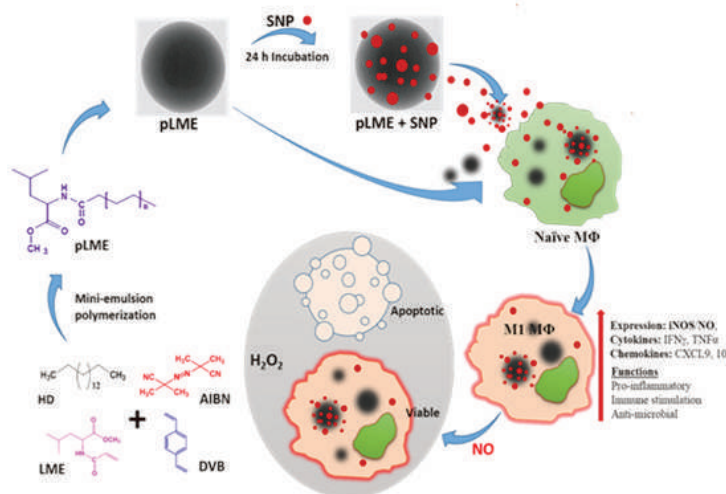

Fig pLME polymer nanocapsule that works as a nano-immune adjuvant with sustained drug delivery, cytoprotective and antibacterial properties. Schematic showing the synthesis, drug loading and their action mechanism on infected cells.

- Researchers at **IIT Kanpur** have demonstrated that a cancer antigen [CD33] targeted AAV vector is efficient in targeting myeloid leukemia cells. This targeted viral vector when used in conjunction with an inducible caspase 9 gene-based suicide gene therapy is superior in *in vivo* models of acute myeloid leukemia (AML). They have also developed an AAV and drug-loaded Polyketal nanoparticle dual hybrid vector system that has shown significant promise myeloid leukemia cells. Thus, this project has led to the development of new class of suicide gene delivery vectors which can be now extrapolated for preclinical and clinical gene therapy of AML as well as for other solid cancers [eg, hepatocellular carcinoma, breast cancer].

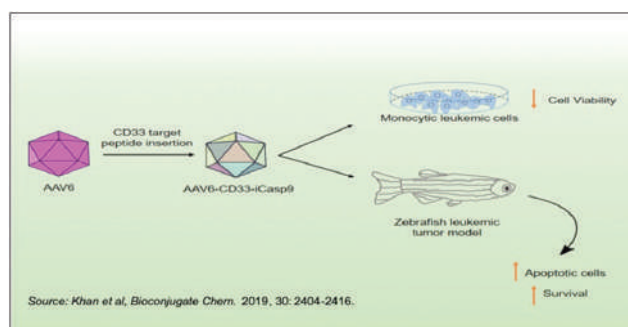
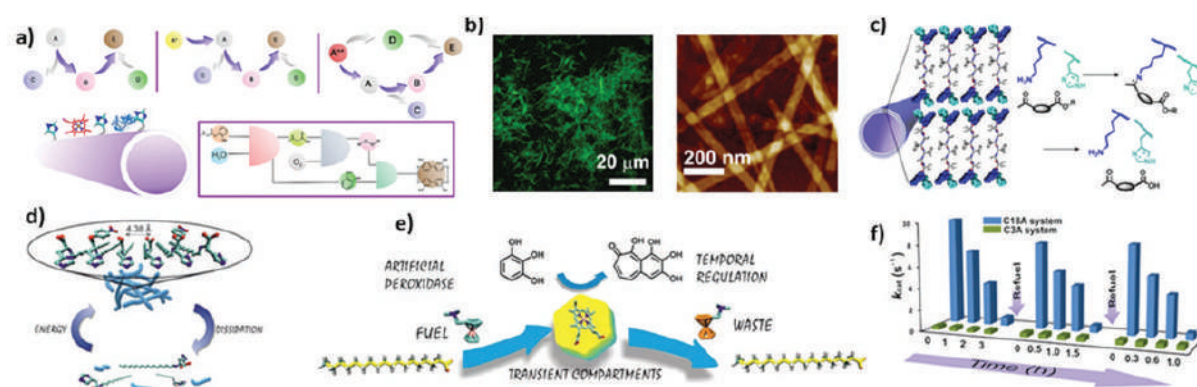

Figure- Development of a targeted suicide gene delivery system based on a Adeno-associated virus platform for potential application in AML.

- IISER, Kolkata**, developed short amyloid-based peptides having numerous active sites along with a native augmenter for exhibiting an enhanced catalytic potential towards hydrolysis reactions via covalent imine bond formation with the substrate. Further, the binding and catalytic potential of these minimal catalysts was exploited to entrap enzymes and cofactors that stimulate complex cascade reaction networks. They further created living matter-like nonequilibrium self-assembled chemical systems, which dissipate energy from the assembled state by utilizing cooperative catalysis. These simple chemical system mirror the microtubule filament formation, where fuel drives assembly and the accelerated catalytic activity at assembled state results in degradation of fuel and disassembly. Controlling the activity of these self-propagating minimal catalysts in a temporal manner was another pronounced challenge which was addressed through transient membrane-less protocells like nanostructures that can host enzymes or co-factors and temporally upregulate and downregulate the enzyme activity thus foretelling compartmentalized biochemical processes seen in living biology.



- At **IISER Mohali**, researchers have revealed the molecular details of aggregation and amyloid formation captured using a combination of techniques involving circular dichroism, fluorescence and Raman spectroscopy and atomic force microscopy (AFM) imaging. They also discovered the liquid-liquid phase separation phenomenon for the amyloidogenic IDPs they have been investigating in their lab. They showed unusual conformational expansion events coupled with solvation and fluctuations drive phase separation resulting in the formation of mesoscopic liquid droplets that can mature into nanoscopic amyloid fibrils associated with Alzheimer's disease. Their broader aim is to characterize the mechanistic, supramolecular and nanoscale features that distinguish functional amyloids from pathological amyloids. The results indicate that ions influence the aggregation kinetics as well as the nanoscale morphology by modulating the autocatalytic ampli-

cation processes. The combination of advanced optical spectroscopy and nano scale biophysics tools serves as a potent approach to study the molecular drivers of the formation of amyloids and their precursors to unveil the mechanism-morphology-function-disease paradigm.

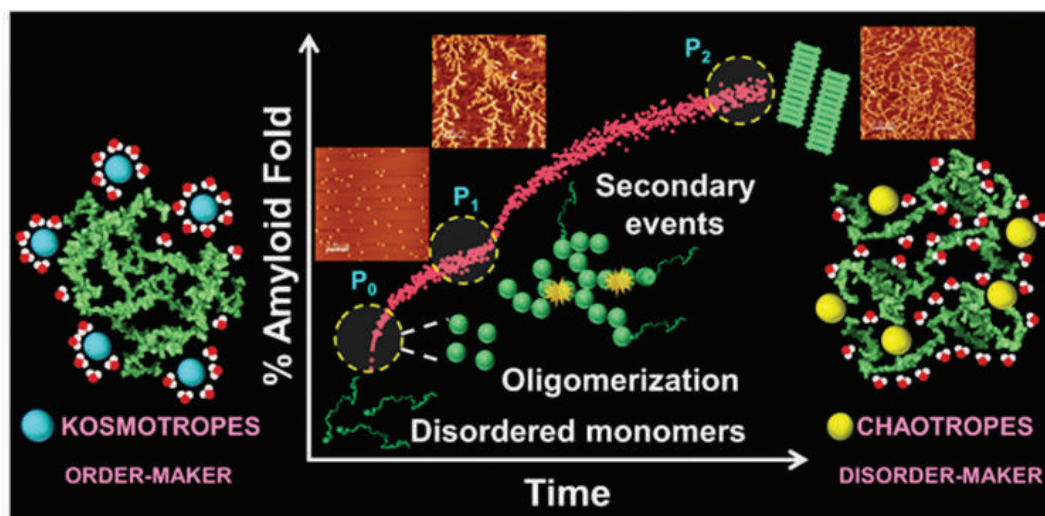

Figure- A schematic of the biphasic aggregation pathway via oligomerization and secondary events involving nanoscale morphological transition

- **At IISER Pune**, a broad synthetic heparan sulfate (HS)-tetra saccharide library is synthesized to evaluate binding affinity with selectins and develop the HS-nanovehicle to target inflammation in the brain. Microarray and SPR binding assay of structurally well-defined HS oligosaccharides shows that 2,6S and 2S-sulfation pattern and *N*-unsubstituted (NU) glucosamine form of HS tetra saccharides significantly enhances E- and P-selectin binding. To highlight the selective targeting, synthetic HS-tetrasaccharides are conjugated on multivalent fluorescent gold nano particles and measured the selectin over expressed endothelial cell-uptake mechanism. Hierarchical clustering of the cellular uptake assay with different degrees of selectin-expressed endothelial cells shows 2S-NU residues of HS as a powerful scaffold in P-selectin mediated nano vehicle delivery to the inflammatory site. Finally, the 2S-NU HS-conjugated nanovehicle shows selective homing of the nano particles in inflammatory endothelial cells in 3D-co-culture spheroids, thus providing a novel target for inflammation diagnostics in the brain.

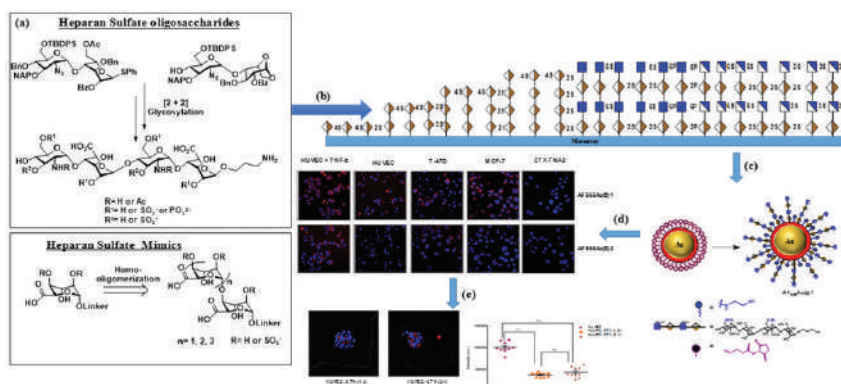

Figure. (a) Synthesis of heparan sulfate oligosaccharides and its mimics (b) Microarray and SPR analysis with selectins (c) Nanovehicle assembly with super active HS analog (d) inflammatory endothelial cells targeting via selectin in 2D and (e) 3D-coculture model.

- Regional Centre for Biotechnology, Faridabad**, engineered two different kinds of nanomicelles using Docetaxel, an anticancer chemotherapeutic drug. In one system, they synthesized a docetaxel-lithocholic acid-polyethylene glycol conjugate that can self-assemble into ~160 nm supramolecular nanomicelles. In another system, they engineered sub-100 nm nanomicelles from a combination of a bile acid phospholipid-docetaxel conjugate and PEGylated lithocholic acid. These nanomicelles showed better safety profile even at high dose and in multiple dosage regimens in mice, and outperformed the marketed formulation of Docetaxel (Taxotere) with prolonged circulation time and increase in tumor entrapment. Pharmacokinetic profile of this formulation is consistent across multiple species like mouse, rat, and rhesus monkeys. The nanomicelles reduced tumor growth and improved survival of mice in a breast cancer model.

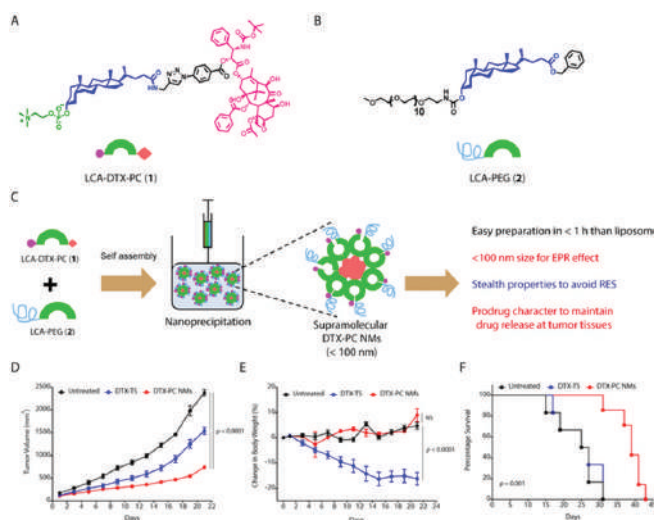

Figure -(A) Molecular structure of LCA-DTX-PC (1). (B) Molecular structure of LCA-PEG (2). (C) Schematic presentations showing preparation of nanomicelles. (D) Change in tumor volume, (E) Percentage change in body weight, and (F) Kaplan-Meier survival curve showing the effect of different treatments

Some noted patents filed are:

1. Suicide gene delivery vectors-Gene delivery vector and method there of-Application no. 201911019997 [complete **application filed -E-2/802/2020/DEL**][*additional validation of iCasp9 suicide gene in a different model system*]
2. A mesoporous anti-microbial nanocomposite and a method of preparation thereof, **Application No.: 202011031802, dated: July 24, 2020**
3. *Biocompatible nano-triblock-co-polymers and a process for their preparation, Application No.: 202011029248, (9th, July 2020).*
4. Temperature sensitive porous polymer film for biomedical applications and a method of its synthesis, **Application No.: 202011020948, May 18, 2020.**
5. A method of synthesizing carbon dots and a product thereof, **Application No.: 202011018557, Dated: 30th April, 2020.**
6. A novel hydrogel with high mechanical stability and a method of making the same, (Ref: **201811045481, TEMP/E-1/49511/2018-DEL, December 1, 2018. (The Patent Office Journal No. 23/2020, Indian Patent Office published on June 05, 2020).**
7. Poly-N-Acryloyl L-Leucine Methyl Ester Hollow Nanocapsules (pLME) for Drug Delivery & Antibacterial Properties: Method of Fabrication and uses (Ref: **TEMP/E1/35596/2017CHE, dated, 02/10/2017), Application No. 201741034846A- The Patent Office Journal No. 14/2019, Indian Patent Office published on 05-04-2019**
8. Method for synthesis of Nanoparticles using Biodiesel ,**Application no. 201811035292 , Filing date :19/09/2018, Publication date : 20/03/2020**

Nano Technology & Applications Research Promotion

During the year 2020-21, we have had one meeting of the Nano Application and Technology Advisory Group (NATAG) till now, which was organized on a web based platform on 30th June, 2020. In this meeting, the NATAG gave, in principle conditional approval, to 5 projects from the 11 projects invited for presentation. One of these proposals, after submitting the product specification, is now pending its approval and is the first project under Nano Technology for developing an instrument indigenously, a step towards AatmNirbhar Bharat.

During the year, as the lock-down began, the importance of masks, was recognized by the Nano Mission Secretariat, and it was decided to give a call for proposals for “New Nano Coating material” which can be easily applied on cloth for making masks which act as a hurdle for enabling virus to enter the breathe of any person or individual. Another Challenge was to “Develop appropriate light material for manufacturing PPEs”, which were now becoming essential for Health Professionals and related manpower.

The advertisement for “Call for Proposals” was floated on 4th April, 2020 with 30th April, 2020 as the last date of submission, along with a manufacturing partner, who will be responsible in mass manufacturing of masks and PPEs. We received 232 proposals, and an Expert Committee, which met 3 times within a month, recommended only 6 Industry-Institute proposals for support. Financial support has been given with release of first instalment to these projects. These were projects for a period of 12 months with a support between Rs 8 lakhs to Rs 24 lakhs with no support under “Capital” given. 5 of these projects were for making reusable masks which would destroy the virus from entering the breathing space and their first version was made available for consumption by general public from on-line web based marketing platforms like Amazon, Flip Kart etc. Some of them were distributed by the Institutions to the people living around the campus or in the open, free of cost, through an NGO which lectured these masses on the importance of wearing reusable masks during the peak period of the Pandemic. Apart from these 6 projects, 4 more projects recommended earlier were sanctioned in this financial year.

Apart from the regular Schemes of Nano S&T, last year we had given a Special Call for proposals in three THEMATIC areas was made. These areas were:

- Nanotechnology for Agriculture – 116 proposals were received
- Nano for Energy and Environment – 199 proposals were received
- Quantum Materials with novel properties and applications – 59 proposals were received.

During last year, the NMC had finally recommended 3 projects each from the first 2 areas and 9 projects from the last area for support. During this year, we sanctioned financial support to the three projects in the area of **Nanotechnology for Agriculture** wherein part support to one of the proposals was also provided by Indian Farmers Fertiliser Cooperative Limited (IFFCO), who have set up a Centre for Research in Nanobiotechnology in Gujarat.

Scientific highlights from Nano Technology projects

Nanoelectronics Network for Research and Applications (NNetRA) : The collaborative program with Ministry of Electronics and Information Technology (MeitY) and 5 participating premier Institutes towards establishing cross-Institutional collaboration to take the Nano Electronics research to technology readiness level (TRL-7 or higher) for possible industrial technology transfer, have successfully identified 17 projects out of 46 that can be nurtured further to bring up indigenous technologies a step towards Atma Nirbhar Bharat.

Selected research highlights from projects funded under Nano Technology scheme and from collaborative efforts:

- i. **Development of nanoparticles incorporated polymeric high flux (HF) hollow fibre nanofiltration prototype for desalination of brackish water**

FESEM of GO nanoparticles incorporated Hollow Fiber membrane

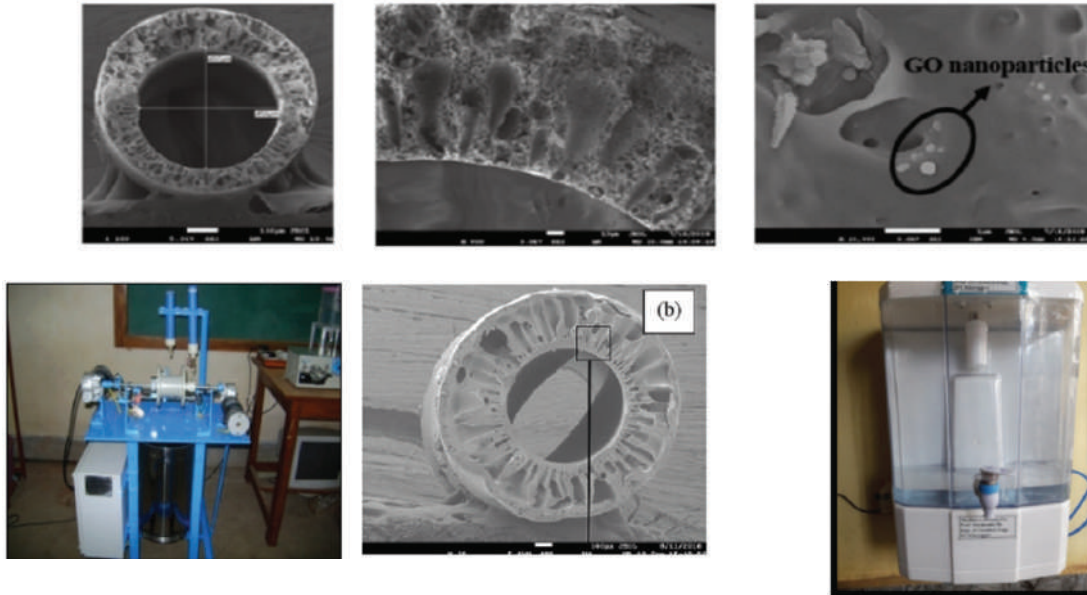

Task-II Development of Technology for spinning HF membrane incorporating identified nanoparticles (GO and polysulfane)

Projected specification of the filtration technique

- a. Filtration rate: 20-40 l/h
- b. Retention of dissolved solids: 60 – 80%
- c. Fabrication of multistage filtration unit to get total dissolved solids concentration less than 500 mg/l (potable) from brackish water with TDS minimum filtration area: 0.8-1 m²

ii. Bio-inspired Large Area Conformal and Flexible Sensor for Biomedical and Robotic applications

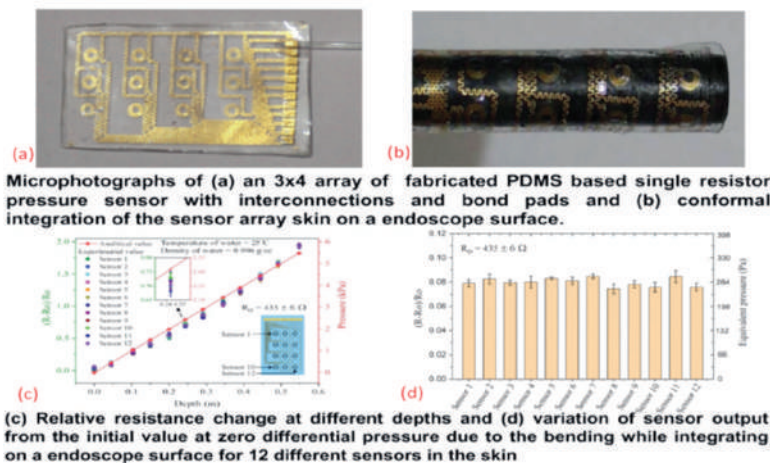

iii. Simultaneous monitoring of multiple cytokines via SERS signals using critically coupled optical perfect absorber sensor substrates



Figure 1: Various steps used for fabrication of the nanohole structures using shadow sphere lithography

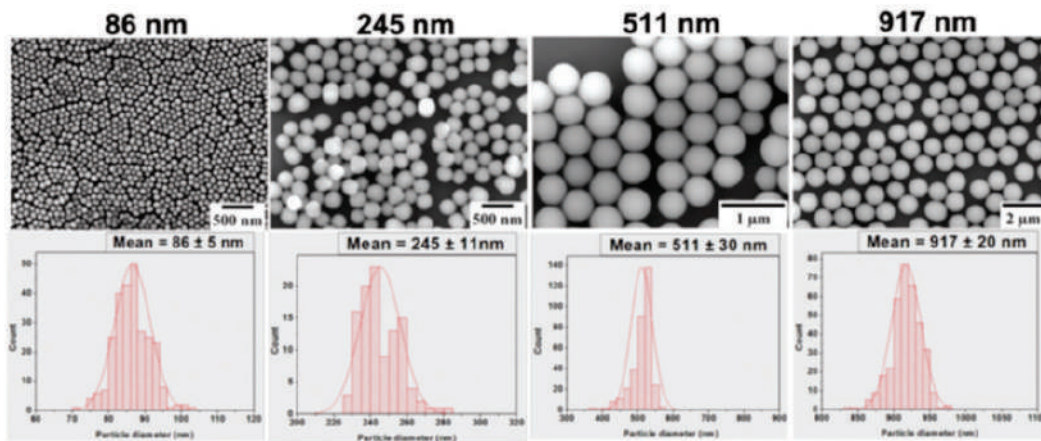

Figure 2: SEM images and corresponding size histograms for the synthesized silica particles

The observation from the results are as follows:

- Thickness and radius control can allow to tune the resonance excitons of the structure
- By single step metal deposition nanoholes can only be formed
- Size of the SiO₂ nano particle are strongly depend on water in the precursor

Applications:

- Nanohole structure can be used as plasmonic biosensors
- Help in tailoring the emission properties of quantum emitters

Achievements of some of the ongoing Thematic Units of Excellence are as follows:

Thematic Unit of Excellence on Computational Materials Science at IISc, Bengaluru

A phase field model was developed to study destabilization of cylindrical pores in membranes. Spinodal decomposition in ternary alloys was studied using an extended Cahn-Hilliard model.

The theory of precipitate growth was extended to multi-component systems, and a critical comparison revealed a good agreement between these results and those from computer simulations based on a phase field model of growth of a single, isolated precipitate in an infinite matrix in ternary alloys.

In the area of protein folding the TU focused on understanding the early stages of protein folding and addressed a controversial problem related to protein collapse. They are also developing coarse-grained models to study salt effects on biological systems. TU has succeeded in building a coarse-grained protein model to describe Hofmeister effects.

They have worked extensively on assessing nanomaterials for gas storage, well assisted studies of the properties of confined fluids for tribological applications and investigated the interaction of pore forming proteins with biological membranes.

TU has also carried out research in various areas such as thermoelectric, 2D materials, defects, catalysis, optical properties, topological materials, and image processing of structural materials using the first-principles approach and machine learning (ML).

They have also carried out research in development of methods for computation of solid-fluid interfacial free energy and also development of a more improved thermodynamic theory of gas hydrates, prediction of dissociation temperature of TBAB semi-clathrate using molecular simulations and study of mechanism of anti-freeze activity for Type-III Anti-freeze protein (SP).

- Number of Publications (only in 2019-2020) : 82 publications in reputed journals
- Patents filed/granted :NA
- Manpower trained : include project assistants and research associates :18
- Number of Ph.Ds. :17

Computational Studies on Novel Materials and Nanoscale Transport at Savitribai Phule Pune University

- Main aim of the project was to set-up a high performance computing facility in the western part of India for research in materials science. SAHASRAR High Performance computing cluster, comprising of 46 compute nodes (then the latest Haswell processor from Intel - 2 Intel Xeon E5- 2697-V3 2.60GHz, 35MB, 14 cores CPU, 128/256 GB DDR4 2133MHz memory), 2 GPU nodes (2 NVIDIA Tesla K20), and 400 TB PFS storage (with 8Gbps write and read (1:1) throughput, using SAS and NL-SAS hard disks) was installed under the project. Mellanox infinib and switches are used as backbone to the cluster. Data Center (DC) facility of tier II type, with two 88 KVA UPS, two 120KW water chillers in redundant mode, has been created to cater SAHASRAR.

- Accordingly, to the 18th Top Supercomputers-India list released by IISc, Bengaluru on July 21, 2017, SAHASRAR got entry at 24th position. The Peak performance of the cluster is 55.91 Tera Flops. List available at <http://topsupercomputers-india.iisc.ernet.in/jsps/july2017/index.html>.
- Most of the other research objectives have been fulfilled by the PI, co-PIs and their groups. The broad areas are listed below:
 - Electronic structure and other relevant properties like photocatalytic properties, optical properties, multiferroic or magnetic properties, X-ray photoemission spectra etc. of clusters, quantum dots, 1D and 2D structures of semiconductor materials are investigated using density functional based methods for applications in energy harvesting like materials for efficient solar cells and efficient water splitting. Transport in nano structures is studied for applications in devices like tunnel diodes.
 - Electronic structure of computationally newly designed 1D and 2D materials is analyzed using first principles methods to understand the underlying science, bonding amongst the constituents and sometimes also to explain experimental observations. Cluster assembly route to design new phases of 2D materials has been proposed. Few examples with important results are given in the attached file.
 - Nudged elastic band method coupled with kinetic Monte Carlo simulations, a model involving 170 mechanistic pathways is built with about 250 computationally expensive nudged elastic band calculations along with phonons for the transition and the initial state. To the best of our knowledge, our work is the first report of providing microscopic understanding of growth of small clusters on MgO support. These calculations have been possible only due to “SAHASRAR” set up from the Nanomission project.
 - Classical molecular dynamics simulations were employed to characterize structure and dynamics of ion transport in ionic liquid doped polymer membranes for application in fuel cells. The system sizes up to 140,000 atoms were investigated for several systems for long simulation time ~75 ns. These calculations were not possible without “SAHASRAR”.
 - The researchers and faculty here are now using the 733 TF system now installed at IISER Pune under National Supercomputing Mission (NSM) to carry on further R&D in the area which is computer intensive.
 - No. of Ph.D. Degree awarded : 08
 - No. of M.Phil. Degree awarded : 04
 - Technical personnel trained : 08 + several UG and PG students carried out their project work under the PI and co-PIs.

- Papers published only in cited Journals (SCI)69
- Invited talks given in National and International Conferences, symposia, etc. by the PI and co-PIs 45
- Papers/posters presented in National and International Conferences, symposia by the members of the research groups : 41, 7 of these received best paper/poster awards including in International workshops/conferences

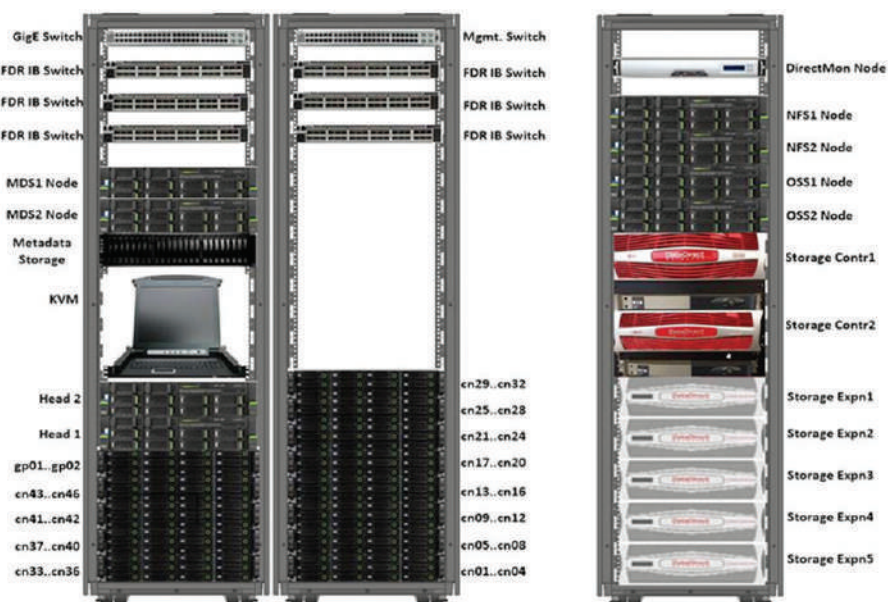

Schematic of the HPC facility SAHASRAR

Development of Lab-on-chip platforms for Efficient and Automated Farming (LEAF) at IIT Delhi

Electrochemical point-of-care sensors for soil nutrient assessment:

The project adopted a multi-disciplinary and multi-pronged approach to develop **indigenous** electrochemical sensors targeting agricultural applications capable of

- real-time and on-field deployment
- qualitative and quantitative analysis of range of macro-nutrients (Nitrates, Potassium and Phosphorous), micronutrients (Iron, Magnesium, Zinc, Calcium) and heavy metal ions (Cadmium,Mercury)
- working across a range of soil salinity (500 – 2500 ppm TDS levels) and soil pH (4.0 – 8.5)
- with a device-level reliability and reproducibility of~95%

- multiplexing and multi-variate analysis for improved accuracy

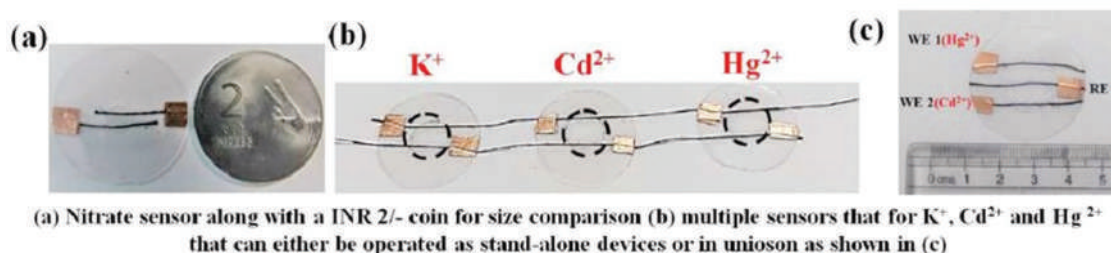

Such sensors are also affordable with an estimated bill-of-materials cost of INR 2 per sensor. The photo of the device-prototypes are shown below

Battery-operated, handheld water-desalination system (*Chakra*):

A battery-operated, hand-held portable water desalination unit called *Chakra* that can be used at household-level to desalinate ground water covering TDS range of 500 – 4000 ppm within 5 minutes. It removes dissolved salts in water such as Na^+ , K^+ , Mg^{2+} , Ca^{2+} , Cl^- , SO_4^{2-} and F^- , thereby making the water safe to potable purposes. The photo of the prototype is shown alongside.

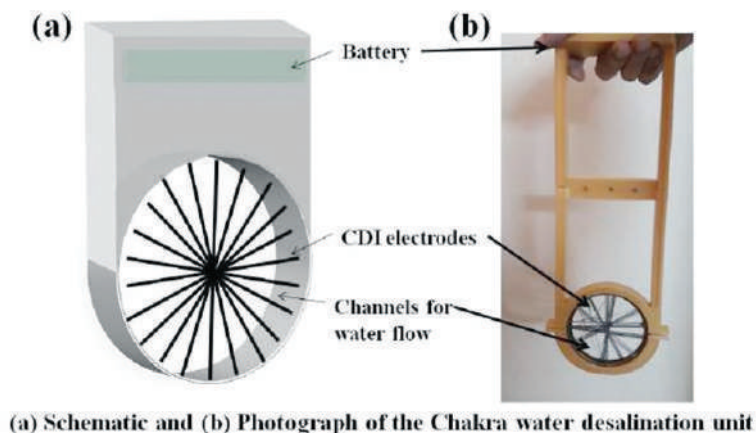

Development of an Application Specific Integrated Circuit (ASIC) for potentiometric measurement

An ASIC component was indigenously developed to integrate with the electrochemical sensors and provide inputs for measurement and process the output to deliver readable/decipherable outputs for the end-users.

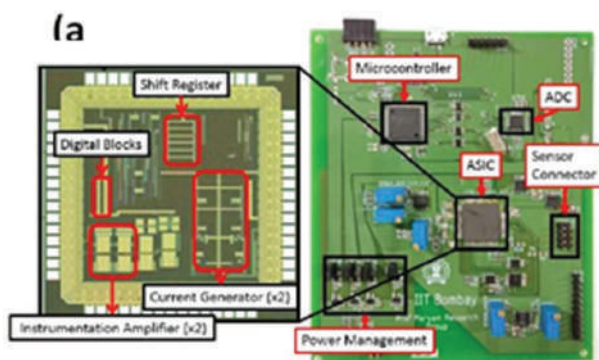

ASIC and PCB Design for potential measurement

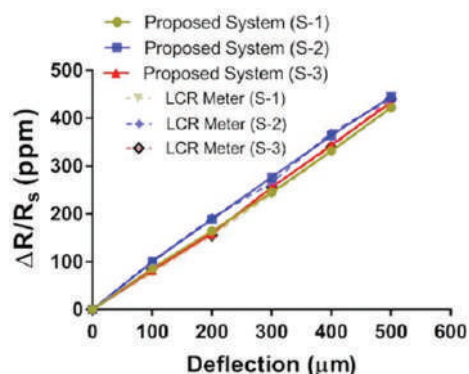

Measurement characteristics for proposed instrument with standard instrument for benchmarking and validation

Development of three electrode paper based pH sensor for agricultural applications

Affordable, paper-based electrochemical sensors for determining soil pH were fabricated, tested and validated with various types of soil.

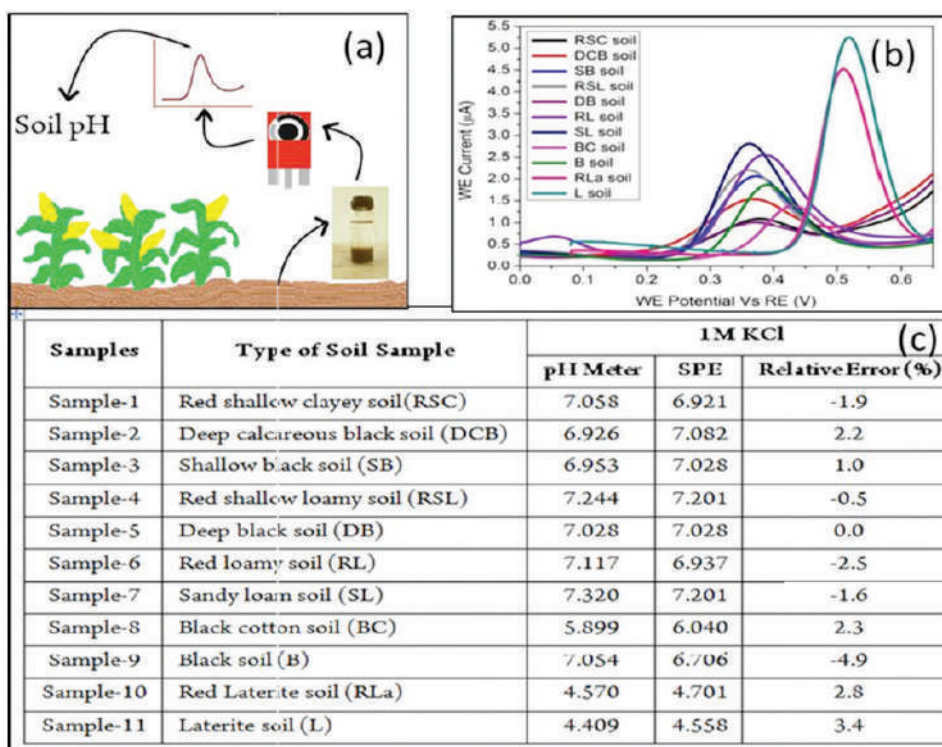

a) Methodology of soil pH sensing

b) Volumetric plots for different soil samples

c) Comparison of observed soil pH with the conventional glass electrode

PET based MEMS Platform for Gas Sensing

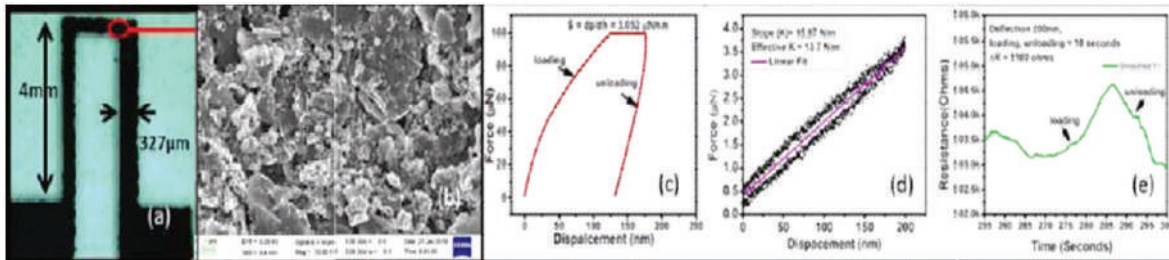

An optical image of piezoresistive PET cantilever, (b) along with the SEM image of the graphene nanoplatelet based piezoresistive layer, (c) Loading and unloading curve for piezoresistive composite film, (d) force versus deflection plot, (e) plot of change in resistance versus deflection for the PET cantilever.

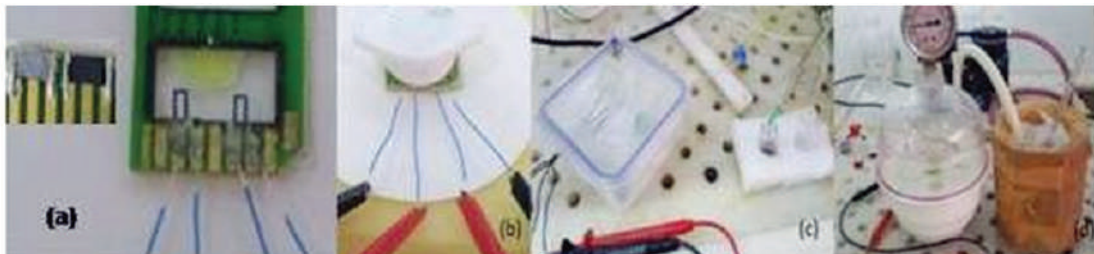

(a) PCB mounted PET chemiresistors and piezoresistive cantilevers with and without the ZnO- CuO sensing layer, (b) PCB mounted sensor with Teflon gas chamber; Sensing unit used for ambient (c) and evacuated (d) conditions with in-situ H_2S gas generation

Optical platforms for early-stage detection of plant pathogens

- Under the aegis of the DST Nanomission project, research was carried out to develop a Lab- on-Chip based photonic sensing platform. Various avenues were investigated to develop the different components necessary for such a platform and biosensing protocols were developed for the detection of different plant pathogens, that will be targeted for detection using such a composite platform. The various platforms investigated were:
- Optical fiber-based platforms (Straight, U-bent and D-shaped) were utilized for the development of bio-sensing protocols for the detection of viruses infecting Tomato and Chili plants using receptor functionalized Goldnanoparticles.
- Work was carried out on the development of polymer-based waveguides which will serve as the platform of choice for the biosensing protocols. An indigenous system was established to measure and process the signals being sent through the waveguides.
- A mechanism was established for the simultaneous optical and electrical reduction of Graphene Oxide for tuning its bandgap. This allows us to leverage the photodetection capabilities afforded by the reduced Graphene Oxide by integrating it with the polymer

waveguide, to measure the signals being transmitted in the waveguide and hence achieve a complete Lab-On-Chipsystem.

- Tetra-amine-porphyrin (TAP) has also been used as a sensor for the detection of nitrates and chloride compounds relevant for agricultural micronutrients and differentiating both on the basis of the optical spectrum pattern achieved.
- A Prism based Attenuated Total Internal Reflection (ATR) based Table top assembly has been developed by making use of Off-the-Shelf Components, for the detection of plant pathogens. An optical chip coated with receptor functionalized Gold nanoparticles was placed on top of the prism (based on the protocols developed for Chilli and Tomato Viruses) and the whole assembly can be used as a mobile detection module.

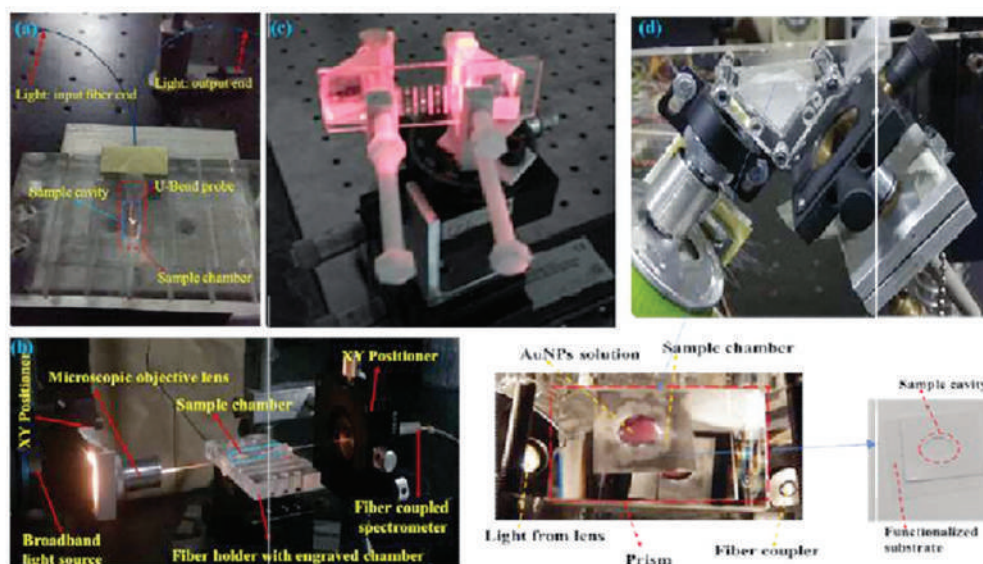

Experiment for (a)Tomato leaf curl virus detection using U-bent fiber probe, (b) tomato leave curl virus detection using D-shaped fiber probe, (c) light guiding in a polymer-based waveguide platform, (d) ATR-LSPR platform for Chillileaf curl virus detection.

1. Details of Scientific output

Journal Publications	29
Patents granted	1
Patents filed	6
Ph.D.s supported	8
Manpower trained (post-M.Sc.)	10

Thematic Unit of Excellence on Computational Materials Science at S.N.Bose Centre**Research: Computational Study of Hard and SoftMatters**

1. **Electronic Materials:** Electrons play the crucial role in controlling most of the properties of materials and providing the microscopic understanding. Understanding of electronic structure is therefore of immense importance in the field of materials research. Research has been carried out understanding electronic materials both in bulk and in nano form. A number of new phenomena has been observed and a number of new insights has been obtained. Some of the important findings are:
 - Understanding the novel magnetic behavior in quantum spinsystems.
 - Understanding of cooperativity and hysteresis in metal organic spin cross over compounds, which should lead to designing of spin-crossover polymers with large hysteresis loops operating at room temperature having application as memory devices.
 - Understanding mechanical degradation and improvement of formability of metals.
 - Understanding properties at interfaces and surfaces of oxides.
 - Electronic, Magnetic and Phase stability of binary alloy clusters.
 - Magnetism and its control in graphene through adatom and creation of open edges.
 - Computer simulation, and understanding of instabilities in ultra-thin nanowires.
2. **Complex Fluids and related Materials:** Complex fluids are composed of variety of components. These systems are not only pedagogically interesting, but also important in various applications. These systems can be easily tuned to study various non-equilibrium and dynamical aspects which have been the major focus of the activities. The primary tool in these investigations has been long time Molecular Dynamics simulations on large systems of complicated molecules. The important findings are as follows:
 - Microscopic reorientation mechanisms.
 - Dynamic heterogeneity and collective dynamics in complex systems & Non-equilibrium effects.
3. **Bio Materials:** Bio-macromolecules may provide unique systems which can be fabricated to design novel materials. One major endeavor has gone to this direction. The most important features of the bio-molecular systems are: (1) large number of atoms and (2) importance of electronic redistribution while ligand binding takes place. There has been focus on both the aspects.

(I) Total number of publications:120

(II) Man power training

Scientist-D: Academic (3) & System Administration (1)

Guidance of Students:

Ph.Ds Produced no: 16
Technical Personnel trained: 41 (36 PhD student + 5 Post-doc)

Infra-structure Development

A 75 Tflop Cray XE6m System with Three Compute (CPU) cabinet - Eight Chassis System with a total of 61 Compute Blades and 7808 compute cores/processors, connected through Gemini Interconnect (3D Torus) has been installed in May, 2014. The machine is now in fully running condition, with a utilization of about 90%. The following shows a picture of the machine.



Thematic Projects in Frontiers of Nano S&T (TPF-Nano) on Nanoscience for Clean Energy at IISER, Pune

Dr. Ogale and coworkers (*ACS Appl. Energy Mater.* 2019, 2, 6, 4450-4457) have developed Fe-MOF based Liion battery anode with excellent reversible capacity of 800mAhg^{-1} at 250mA g^{-1} and equally impressive rate performance (specific capacity of 500mAhg^{-1} at a high rate of 3Ag^{-1}). The LCO/ Fe- MOF anode full cell exhibited a fast charge and discharge, affording a specific capacity of 38mAhg^{-1} in 2 min of charging time and a very good rate performance (40mAhg^{-1} at 7A g^{-1}), with a robust stability upto 1000 cycles. A flexible device was fabricated using a free-standing LCO cathode and a Fe-MOF anode MWCNT composite and employed as a heat generating skin patchable complement for the transdermal drug delivery application.



Angshuman Nag and his group have been exploring metal halide perovskite nanocrystals for optoelectronic applications like solar cell, light emitting diodes, and photo detectors. In this work, they design novel materials, study their photophysical properties, then if the desired properties are achieved, then look for preliminary device applications.

Colloidal Metal Halide Perovskite Nanocrystals								
For defect tolerance	Bright			Bright			Can replace Pb	
Dopant ion	Adding Defect			Adding Defect			Plasmonic coupling	
25 Mn 54.94	26 Fe 55.85	27 Co 58.93	28 Ni 58.69	29 Cu 63.55	30 Zn 65.38	31 Ga 69.72	32 Ge 72.63	33 As 74.92
43 Tc 98.90	44 Ru 101.07	45 Rh 102.91	46 Pd 106.42	47 Ag 107.87	48 Cd 112.41	49 In 114.82	50 Sn 118.71	51 Sb 121.76
75 Re 186.21	76 Os 190.23	77 Ir 192.22	78 Pt 195.08	79 Au 196.97	80 Hg 200.59	81 Tl 204.38	82 Pb 207.2	83 Bi 208.98

HUMAN RESOURCE DEVELOPMENT

During the year following activities with major focus on Human Resources were supported:

- Support was also continued for Post-doctoral Fellowships to attract talented young researchers towards advanced research in Nano Science & Technology through the Jawaharlal Nehru Centre for Advanced Scientific Research, Bangalore. The NMC had approved the IV National PDF Scheme for 40 students in 5 years. However, due to the COVID lock-down several students had to return back and hence that data has been received now. We are likely to provide an Extension till 31.03.2021 for the IIIrd Phase to enable the Fellows to complete their NPFD under the PDF programme (III Phase) while we get the IV Phase approval..
- Similarly, support also continued for the Nano S&T Overseas Fellowship, that has been extended within the sanctioned cost till 31.01.2021, and all the 4 Fellows abroad have been safely brought back to India after completion of 1 year of this Fellowship. We are discontinuing this Fellowship after 31.01.2021, in view of many applicants not meeting the benchmark set by the Committee for selection.

- Ongoing PG Programmes: Support to 5 ongoing Post Graduate programmes [M.Sc./M. Tech in Nano Science & Technology] continued this year too at several institutions across the country. However, this programme has been discontinued from year 2018 onwards and we are settling the earlier supported cases.
- New Faculty Associateship programme 2019-20: Nano Science & Nanotechnology Visiting Associateship in 14 Institutions supported by DST and few Institutions supported by M/o Electronics and IT (MeitY) on a Pan-India basis is likely to be initiated in FY 2021-22 in a pro-active manner.

Inter-Ministerial Coordination

Nano –Regulatory Guideline

Nano GUIDELINES on Nano Pharma- Contributed extensively as Inter-ministerial Expert Committee Member (page 14) towards preparation & finalization of “**Guidelines for Evaluation of Nanopharmaceuticals in India**”, already released through DBT by Hon. Minister of S & T, on 24th Oct 2019.

(The guidelines apply to the nanopharmaceuticals in the form of finished formulation as well as API of a new molecule or an already approved molecule with altered nano-scale dimensions, properties or phenomenon associated with the application of nanotechnology intended to be used for treatment, in vivo diagnosis, mitigation, cure or prevention of diseases and disorders in humans. These guidelines had DCGI as a member and hence have been made in consultation with the regulatory authority for manufacturers, importers of nanopharmaceuticals and other stakeholders involved in research and development of nanopharmaceuticals.)

Nano GUIDELINES on Nano -AGRI- Furnished Technical Inputs as Inter-ministerial Expert Committee Member (page 55) towards preparation & finalization of, “**Guidelines for evaluation of nano-based agri-input and food products in India**”, March 2020 .

(These guidelines would help policy makers and regulators to frame effective provisions for future novel nano-based products in the agri-input and food sectors of India. These guidelines also provide suggestions to ensure human, animal and environmental safety considerations for these upcoming novel products.)

International Collaboration in Nano S&T

We under the Nano Mission have 4 International Collaborations with the following:

1. MoU with DESY, Germany for using the PETRA-III State-of-Art Synchrotron by Indian Scientists for experimentation.

2. KEK Photon Factory at Japan where we have built an experimental facility for conducting experiments by Indian researchers
3. MoU for sharing beam line at Rutherford Apsolton Laboratory in UK.
4. MoU with typical Synchrotron in various countries for specific experiments by Indian Scientists

PETRA-III Synchrotron of DESY, Germany at Hamburg

The Bilateral Steering Committee meeting of the Indian Beamline for Nano Science and Technology at PETRA-III, DESY, Germany – Phase II was held on Monday 22 June 2020.

The committee had discussions on the alternatives for utilization of allotted beam time. Since only few users could carry out their experiments before the lockdown due to COVID 19. However, because of the travel restrictions and lockdown due to COVID 19, many of the users could not use their allotted beam time. While only one user has used the FLASH experiment in the first phase of the project.

Since, we have to utilize allotted 658 beamtime hours during this period till 31.03.2021, and complete the required man hours in the 5 years of the project alternative solution was essential. Proposed to keep with allowed per-diem 4 scientists (preferably postdocs or students who have submitted their Ph.D. thesis) for 6 months stationed in the PETRA III beamline to carry out the experiments on behalf of the Indian users. PETRA III experiments can be classified into 3 categories of experiments, namely, 1) Powder and single-crystal X-ray diffraction at ambient, temperature-dependent, pressure-dependent environments, 2) Electronic structure determination, 3) Soft matter, nanomaterials, etc. Each of these requires a separate skill sets. In addition, we have more than one experiment on different beamlines being run concurrently, thus requiring more personals on the beamline at the same time. Stationed scientists will have experience in synchrotron experiments with different skill sets. The above temporary arrangement will also create trained manpower in the form of students and postdocs in the country and create experienced users of synchrotron, which is one of the important objectives of the project. The Steering Committee agreed to extend the project, within the sanctioned cost, till 31.03.2022 to enable India to use its beamtime hours.

The actual proposer will interact with the scientist stationed through video links during the experiment and will send the samples by courier service much before the experiment. This arrangement will not allow significant modifications of the experiment based on obtained data on the spot, which is important for many synchrotron experiments. The persons doing the experiments will be part of the publications based on these experiments. This arrangement is a stop-gap arrangement for six months only.

Also there were discussions on:

- How to integrate Indian community in Centre for Molecular Water Science (CMWS) initiative. The document of the same circulated with the member
- To join the Trilateral Summer School, RACIRI - with Russia, Sweden & German - with financial support from Nanomission.

KEK Photon Factory, Japan

The Bilateral Steering Committee meeting of the Indian Beamline, Photon Factory, KEK Japan was held on 23rd September 2020 at Japan. Committee had discussions on the Phase 3 of the India Japan Collaboration on the Indian Beamline up to March 2027 from March 2022. The project also has been extended within the sanctioned cost from June 2021 till 31st March, 2022 to enable Indian researchers to utilize their allotted time.

We also participated in the Indo-Japan Working Group meeting, where the Japanese supported the extension while waiving off the O&M charges for extension till 31.03.2022.

Present picture of the experimental Hutch

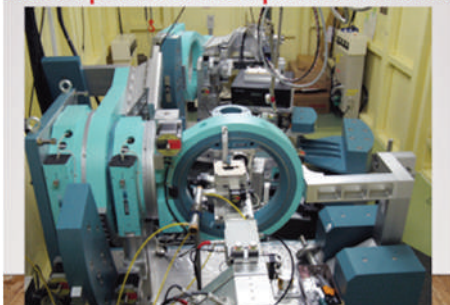

HIGH PRESSURE SETUP AT BL 18B



MoU with Rutherford Appleton Lab in UK

The Bilateral Steering Committee meeting of the India-Rutherford-Appleton Laboratory in UK was held on 28 October 2020.

Few highlights of the achievements under the collaboration:

- Total number of direct access proposals supported by Nanomission-25

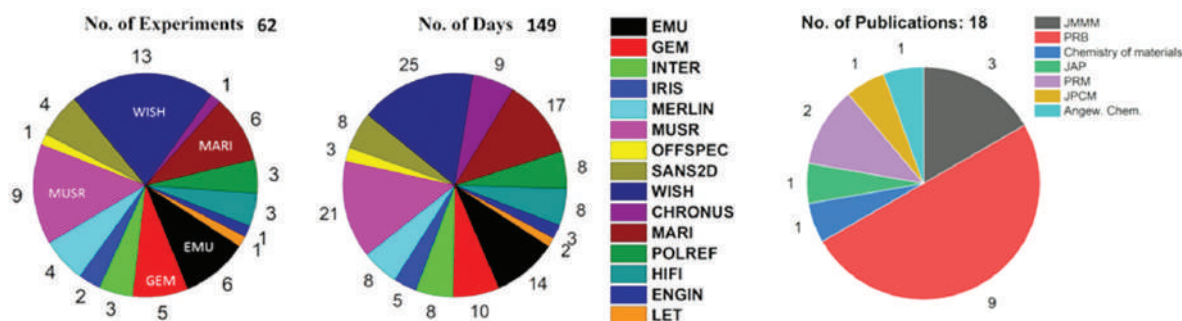



User Mapping for The Facility Across India

- One day science meeting was organized at Inorganic Chemistry, the University of Oxford, where Prof. C. N. R. Rao gave the prestigious RJP Williams Lecture 2018.
- India-RAL Neutron and Muon, the workshop was held in JNCASR Feb 5-6, 2019. Data Analysis of neutron scattering and muon spectroscopy.

Looking at the success of the Phase I the Committee desired that the discussion on the next phase of the project be initiated at the earliest opportunity to enable submission of the proposal to DST.

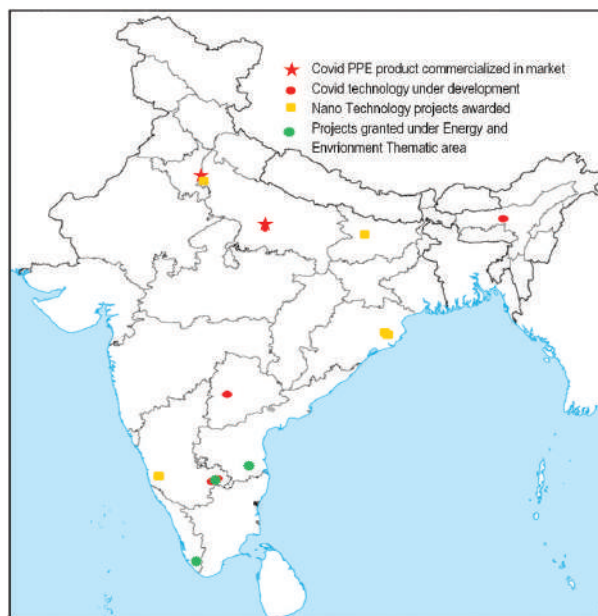

Pan India distribution of Nano Technology Projects – 2020-21

2.3 Mega Facility for Basic Research

This scheme is aimed to create mega science facilities and launch mega science projects in and out of the country to improve access to such state-of-the-art facilities for the Indian scientific community, especially from the academic sector. Because of technical complexities and requirement of large resources, such projects are manifestly multi-agency, multi-institutional and, most often, international in character. The Department of Science and Technology (DST) and the Department of Atomic Energy (DAE) have been jointly promoting most of such projects in the country. Under this scheme, several important developments took place during the year, which are described below project-wise.

Indian participation in Experiments at the Large Hadron Collider (LHC) at CERN, Geneva

Indian participation in Compact Muon Solenoid (CMS): Upgrade, Operation and Utilization

Indian scientists and research students continued their participation in the experiment. During the year, 14 research infrastructures were created which includes, Gaseous Electron Multiplier (GEM) detector assembly and testing set-up, Resistive Plate Chamber (RPC) detector assembly and testing set-up and Clean Room of Class 100, all three each at Panjab University and Delhi University, Silicon detector assembly Centre and Clean Room of Class 10000 at NISER, Precision Lightweight Mechanics Laboratory for CMS Tracker and High Granularity Calorimeter (HGCal) upgrade at IIT-Madras, Lab for HGCal upgrade and system testing set-up at IISER-Pune, Sensor Characterization Centre, Technology Computer-Aided Design (TCAD) Simulation lab for design, understanding and optimization of silicon detectors for radiation hard environment, GEM detector assembly, testing and characterization set-up and Data acquisition system (DAQ) at Delhi University.

During the year, 6 prototypes were developed which includes, GEM detector prototype of size 10 cm x10 cm (shown below) and Front-end DAQ for CMS Phase-II Forward Calorimetry at Panjab University, Prototype of Imaging detector using GEM and GEM prototype detector at Delhi University, Mechanical Modules of glass and silicon wafers for CMS Phase-II Tracker at NISER and CF-AI Tracker spacers, Tracker bridges and HGCal baseplates at IIT-Madras.

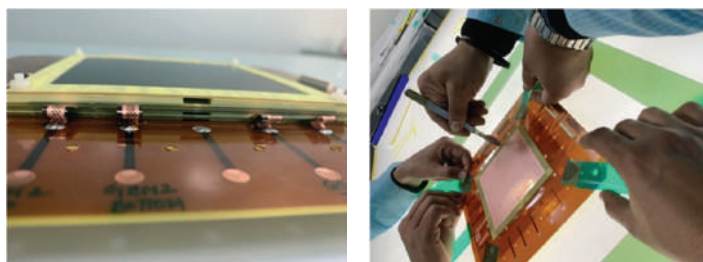

Fig. Prototype GEM Chamber (10 cm x10 cm)

During the year, 2 technologies were developed. Field Programmable Gate Arrays (FPGAs) based system for 4-channel internal triggering was developed at TIFR and X-ray imaging using GEM detector was developed at Delhi University. Designs of n-on-p multi-strip silicon sensor technology was transferred to BEL, Bengaluru.

During the year, 14 GE1/1 GEM chambers and read-out/drift PCBs for GEM detectors were supplied to CERN as in-kind contribution from India. Work on GE 2/1 read-out boards with indigenously developed GEM foils progressed further.

During the year, Indian researchers were joint authors of 98 collaborative research publications. The output also includes 21 conference papers/talks, 5 scientific/technical reports, 14 scientific analysis notes and 12 Ph.Ds. Another 65 Ph.D. students, 5 Post-Docs, continued their research work on the experiment. About 30 UG students were also trained on different aspects of the experiment. 2 Webinars were organized on virtual platform during the year.

Indian participation in A Large Ion Collider Experiment (ALICE): Upgrade, Operation and Utilization

Twelve Indian research groups including 38 faculty members and 50 research students continued to participate in data analysis, detector maintenance and R&D on future upgrade of the experiment. Indian researchers played an active role in ALICE data analysis for various physics results. During the year, 34 papers were published and Indian researchers played major roles in studies related to resonance production, heavy flavour production, jet-structures in high energy heavy ion and in p-p collisions at LHC energy. The project also resulted in 10 Ph.Ds. during the year. One ALICE-India School was organized virtually by IIT-Indore and Jammu University with participation of more than 100 students.

On the hardware front, two major activities took place. The first one was, refurbishing the muon chamber and installation of electronics during the shutdown period.

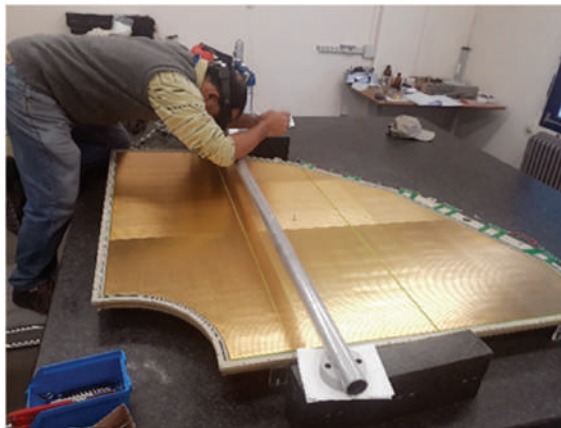

Fig. Muon chamber station under repair at CERN

The second major activity was R&D on development of Si-pad detectors for Forward Calorimeter (FOCAL). For this, specifications were prepared for development of p-type Si-pad detectors on 6" wafers. Discussion on its design and production initiated with two major industries in the country.

Operation and Upgrade of Worldwide Large Hadron Collider Computing Grid (WLCG) system

Support to this project continued during the year. Despite challenges due to COVID-19, WLCG continued enabling the scientists and research students to process the voluminous data obtained from CMS and ALICE experiments. The two Tier-2 Centres, at VECC and TIFR continued working 24x7 and processed more than 300 billion high energy physics events, 20% more than the previous year. While maintaining all the COVID protocols, these Centres were augmented with more than 10000 physical cores of computing and raw 15 Peta bytes of low-cost disk-based storage servers. These Tier-2 and Tier-3 Centres played a crucial role in 'work from home' during the pandemic, facilitating the users to work consistently and continuously across the country.

India's Associate Membership of CERN

Sustained efforts were continued to connect Indian Industry with CERN procurement processes through website and direct industry contacts. Factory visits of Indian companies by CERN technical team were also organized. At present, 54 Indian companies are registered on CERN e-Procurement website, about 45 Indian companies participated in CERN tendering processes and 8 Indian companies received orders worth about Rs. 6 crores from CERN.

During the year, 29 Indian companies participated in CERN Tenders and Market Surveys for supply of 36 items. The details of major orders completed or under execution by Indian companies are shown below.

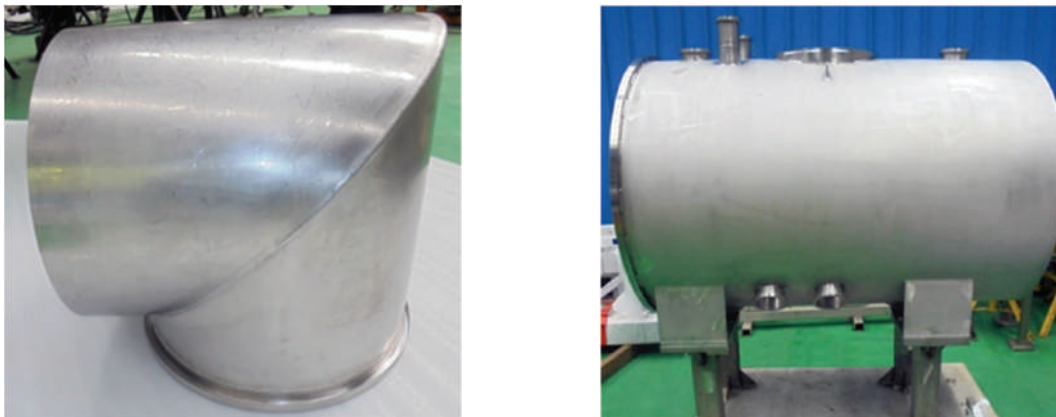

Fig. Fabrication of Vacuum vessels in progress (INOX, Vadodara)



Fig. Cryogenic Tank for liquid argon storage under fabrication (INOX, Vadodara)



Fig. CERN Inspectors doing pre-dispatch inspection of super-proton synchrotron beam tele vision optical line (Macseal, Navi Mumbai)



Fig. Development, customization and migration of CERN websites (Singsys, Lucknow) CERN Council website (Left), CERN Financial and Admin processes website (Right)



Fig. Fabrication of metal bellow expansion joints in progress (Metallic Bellows, Chennai) Prototype Metal bellows (Left), Leak test of metal bellow expansion joint in progress (Right)

Further, as a result of this enhanced engagement with CERN, several Indian students are being placed every year for training at CERN through Junior Fellowship and Technical Studentship programme. Presently 25 Fellows, 5 Technical students, 1 Doctoral student, 1 Scientific Assistant and 1 Project Associate are pursuing their research and training at CERN.

India's Participation in Construction of Facility for Antiproton and Ion Research (FAIR) at Darmstadt, Germany

During the year, implementation of the project gained further momentum. The civil construction continued in full swing at the project site in Germany. Construction of main accelerator tunnel completed while the remaining work continued in full swing. Regarding India's in-kind contributions, i.e., building in-kind accelerator and detector items, viz., power converters, vacuum chambers, beam stoppers, superconducting magnets and advanced detector systems progressed further in the country. Some notable achievements from the same are mentioned below.

Power converters: Despite pandemic, the activities continued and 55 power converters for room-temperature magnets were sent to FAIR as in-kind contribution from India in two batches of 18 and 37.

One prototype was built for superconducting magnets and its production is expected to start soon.

Vacuum chambers: Two prototype chambers were sent to FAIR which passed the necessary tests. During pandemic period, virtual discussions continued towards finalization of production procedure. The production of 56 more chambers was initiated during the year.

Beam stoppers: In continuation of efforts made in earlier years, Central Mechanical Engineering Research Institute (CMERI)-CSIR, Durgapur in collaboration with GSI-Germany completed the Conceptual Design Report and Final Design Report for both static and dynamic modes of operations of beam stoppers and the associated equipment. The process to find manufacturers for the same in the country was initiated.

Advanced Detectors for FAIR experiments: During the year, Indian research groups expected to perform experiments in FAIR completed R&D on advanced radiation-hard, high-resolution detectors and electronics. Also, during pandemic, Indian researchers participated in experiments at FAIR remotely and most of the operations like detector control, monitoring, data taking were performed remotely. The performance by made in India detectors was at par with the detectors made by international teams. Also, the Technical Design Reports were approved. R&D has been completed for all assigned detector types and the production process for these items was initiated.

Regarding scientific achievements, two high-rate bakelite Resistive Plate Chambers were

tested for the Compressed Baryonic Matter (CBM) experiment. One clean room infrastructure was created in the country for fabrication of detectors for FAIR.

An international collaboration meeting on CBM experiment was organized through virtual platform during 19-23 October, 2020 with participation of about 70 persons from different countries.

The project also resulted in 5 research papers in journals and 10 papers in conferences during the year.

During the year, comments from all Ministries/Departments on the EFC Memo for the modified proposal for India's participation in the FAIR project with revised cost and timelines were received and financial appraisal of the project advanced further.

Indian participation in Thirty Meter Telescope (TMT) project at Mauna Kea, Hawaii, USA

Support to this project continued during the year. The civil construction work on the summit of Mauna Kea, Hawaii continued to be stalled due to protests by native Hawaiians, even after obtaining all the fresh legal permits in 2018. The stalemate continued. Regarding the alternate site, La Palma, Canary Islands, Spain, permits were obtained. During the year, a Committee was constituted to compile all the information for both the sites regarding permits, risks, funding, science advantages, disadvantages, etc. The Committee drafted its detailed report which is to be placed with all the Members shortly.

At present, the project is facing time and cost overruns. The project is anticipating funding from National Science Foundation, USA to bridge the funding gap. The exercise on estimate-to-complete and cost-to-complete was completed and Indian in-kind contributions was expected at about Rs. 2218.19 crores against allocation of Rs. 830.20 crores for in-kind contribution.

During the year, design and development activities towards fulfilling India's in-kind obligations for supply of various in-kind items from India which includes segment support assemblies, actuators, edge sensors, segment polishing and segment coating, observatory software and telescope control systems software and first light instruments continued. The progress made towards each item is given below.

Segment Support Assembly (SSA): The contract for 10 SSAs under production qualification phase was given to L&T, Mumbai. The delivery of first 5 SSAs got delayed due to pandemic. Now, the first batch of SSAs is expected to be delivered shortly. Four Indian industries were involved in this work package.

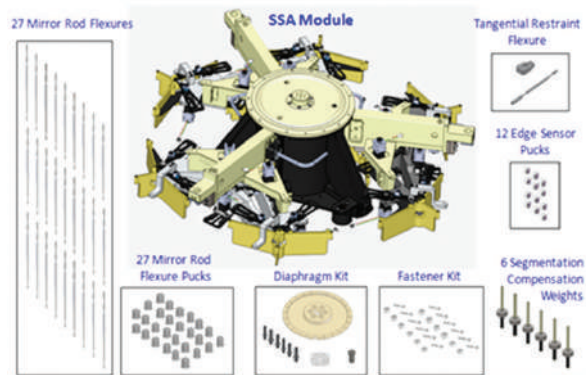

Fig. Detailed parts of Segment Support Assembly

After successful development of prototype central diaphragm, an important component of SSA, price bid for first 10 diaphragms was got evaluated and orders were expected to be placed shortly.

During the year, purchase order for 3 sets of warping harness cables was placed with three vendors and its manufacturing is expected to commence shortly. Warping harness cables set from the prototype round is to be slightly modified in-house before its use for testing of SSAs. The same set would be used for testing of first 5 sets of SSAs.

Four sets of edge sensors flex board were manufactured by two Indian vendors. The work was undertaken to explore the manufacturing capability of Indian vendors to manufacture multilayer rigid flex PCBs. Two sets from each vendor were shipped to TMT project office for review.

Actuators: After successful manufacturing of 20 P2 actuator prototypes by four Indian companies, 3 P3 actuator prototypes were under manufacturing stage during the year. Four Indian industries were involved in this work package.

Edge Sensors: After completion of ultrasonic machining of 10 edge sensor blocks (by Optica, Bengaluru), machining of 1 edge sensor block also got completed (by Paras Defense, Mumbai), while machining and polishing of 9 edge sensor blocks was also completed (by ARCI, Hyderabad). ARCI, Hyderabad and SLTL, Ahmedabad developed laser etching process. Trial coupons were fabricated and coated at Optica were laser etched on 4 blocks by each vendor. Two sensor blocks (1 block from each vendor) along with process documents were sent to TMT project office for further tests. Four Indian industries were involved in this work package.

Segment Polishing: After completion of civil construction of India-TMT Optics Fabrication Facility (ITOFF) at IIA's CREST campus at Hoskote, Bengaluru, several machines including coordinate measuring machine, buy-off station, etching station, thermal chamber were

installed. The ITOFF was inaugurated by Shri Venkaiah Naidu, Hon'ble Vice President of India on 29th December 2020.



Fig. ITOFF building (Left), Hon'ble Vice President of India inaugurating ITOFF (Right)

During the year, a contract was signed between Coherent Inc., USA, India-TMT Coordination Centre (ITCC) and TMT project office for manufacturing, supply, transfer of technology and training of stressed mirror polishing equipment.

Segment Coating: After signing the work package agreement, an open tender was floated and pre-bid meeting was organized during the year. 3 Indian companies participated in the process. The bids were evaluated and contact is expected to be given shortly.

Observatory Software (OSW): After successful completion and delivery of software modules to connect and integrate various sub-systems to the telescope, called the Common Software (CSW) by one Indian company, CSW maintenance work package continued during the year. During the year, Data Management System prototyping work was initiated which progressed further.

Telescope Control System (TCS): The work continued.

First Light Instruments: given below.

Wide Field Optical Spectrograph (WFOS): During the year, India-TMT continued work on the designs of various sub-systems of WFOS and underwent a successful Tier-C review of the Conceptual Design Phase-2.

High Resolution Optical Spectrograph (HROS): India is leading the efforts for design and development of TMT-HROS. During the year, Indian team continued optimizing the optical design of HROS, like, atmospheric dispersion corrector and K-mirror which are part of HROS pre-slit optics, beam compression using prisms, multiple collimator and combination design to reduce optical aberrations as in-house activity. Mechanical layout and space envelope were worked out. Indian team also had discussions with TMT-Scientific Advisory Sub-Committee on HROS science goals, optical design and optimization aspects.

Besides the above mentioned developmental activities, the project also resulted in 2 PhDs, 5 scientific and technical publications/reports and 1 Poster. 14 Indian industries were involved in different project activities.

During the year, 5 meetings of Project Management Board were organized. The progress of the project was also reviewed by the Executive Council during the year.

Utilization of Twin Beamlines for Macromolecular Crystallography (XRD2) and High-Pressure Physics (XPRESS) at the Elettra Synchrotron Facility, Trieste, Italy

Utilization of twin beamlines, XRD2 and XPRESS, for carrying out frontline research in macromolecular crystallography and high-pressure physics by the Indian scientific community continued on a moderate scale due to Covid-19.

XRD2 Beamline: After resumption of operations in August 2020, 5 dry shippers containing 550 crystals were sent to Elettra which resulted in useful scientific achievements. The highlight of one research work performed at XRD2 beamline by IISc group is shown below.

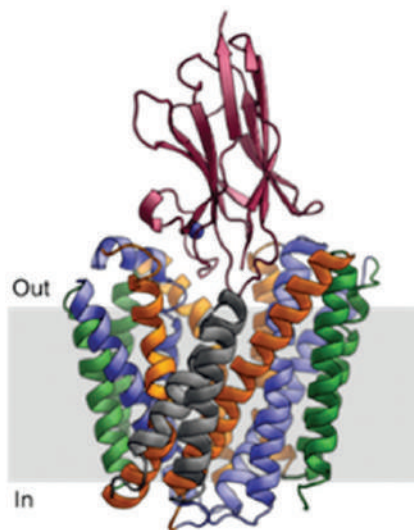

Fig. Highlight of a research performed using XRD2 beamline

In this work, crystal structure of *Staphylococcus aureus* NorC was solved at 3.6 Å resolution. This is an integral membrane transporter protein which was solved in complex with an Indian Camelid antibody, *In* and *Out* represent inner and outer surface of bacterial cell membrane.

A major milestone at XRD2 beamline was implementation of remote data collection, which enabled users to continue their experiments even when they are not on-site. On-site visits are limited to one or two persons at a time providing limited opportunities to young researchers to obtain hands-on training with data collection. With remote data collection, on-site visits are not required and young researchers are involved in the experiments along with their

experienced colleagues and thus get hands-on training. The remote data collection from the country was successfully done from Delhi and Bengaluru.

XRD2 beamline scientists along with IT team at Elettra worked to improve the softwares associated with beamline activities. An automated data processing pipeline using autoPROC was implemented which provided processed data to users few minutes after completion of data collection, thereby helping the users to quickly evaluate the results and redo the experiment with modified parameters such as wavelength, exposure and so on, in the same visit itself without waiting for redoing the experiment in the next visit. The data collection interface MXCuBE is also being improved to enhance the user experience. The procedure for shipping dewars from and to India was also streamlined with support from Elettra.

The access to this high-end beamline enabled about 40 Ph.D. students to carry out their research work. Based on the work done using this beamline, 4 Ph.D. theses were submitted while submission of 7 more such theses was in process. The work also resulted in about 10 research publications in high impact factor journals.

XPRESS Beamline: The beamline was utilized by the users on a moderated scale due to Covid-19.

During the year, a versatile cryoloader system for loading liquid media was developed in collaboration with Elettra and the same was commissioned and used successfully for several loadings. The beamline was also undergoing augmentation with a variety of equipment; new Pilatus 6M detector to enhance its capability for single crystal x-ray diffraction; addition of temperature variation facility; addition of high-temperature stage for samples; and high-pressure Raman and PL set-up. The commissioning all these items is expected to get completed by end of the year and the beamline with enhanced features is expected to be available for users from first half of the next year.

During the year, 6 proposals were executed and 11 research publications emerged from Indian research groups, 5 more publications are under process. The beamline enabled 9 Ph.D. students to carry out their research work.

Utilization of Accelerator-based Research Facilities

Utilization of Low-Energy Ion Beam Facility at Kurukshetra University

Support to the 200 KV Ion Beam facility continued during the year. Some studies related to surface structuring with simultaneous development of regular surface structures (~ order of nm to μm) on silicon carbide, sapphire, aluminum oxide, silicon with planar orientation of (111), low-density polyethylene and high-density polyethylene surfaces were carried out in a controlled manner to understand the interaction processes involved.

Beam time was allocated to 27 users from 6 institutions. 13 users utilized the facility with a variety of gaseous and solid ions. The important research highlight includes controlled surface

structuring of unexplored 3C-SiC thin films by oblique angle sputter erosion. Fabrication of long array of ripple structures on thermally and physically stable 3C-SiC surfaces is expected to show very small-time degradation and are of relevant interest in versatile applications.

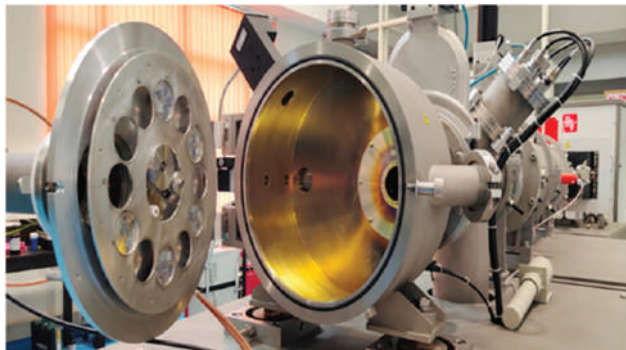

Fig.Target Chamber of Ion Beam Facility at Kurukshetra (Target size, 50 mm diameter)

Installation of important research equipment, glancing angle x-ray diffractometer, RF/DC sputtering system, spectroscopic ellipsometer, CV analyzer and UV-VIS-NIR spectrophotometer completed during the year, thereby augmenting the facility for wider range of experiments in future.

The project also resulted in 5 research publications, 5 conference papers, 3 PhDs and training of 1 technical personnel during the year.

Utilization of High-Fluence Ion Beam Facility at Allahabad University

Support to the facility continued during the year. Utilization of the facility affected due to Covid-19. The project duration was extended till May 2021. During the year, analysis work on previous experiments continued which resulted in 3 research publications and 1 conference paper.

Establishment of India-based Neutrino Observatory (INO) in Tamil Nadu

A letter from the Hon'ble Minister for Science and Technology was sent to the Hon'ble Chief Minister of Tamil Nadu requesting to grant the project team an opportunity to place the facts about the project before him.

Indian Institutions-Fermilab Collaboration in Neutrino Physics

Though Indian researchers could not participate in actual experiments due to Covid-19, some offline project activities and simulation work continued by 10 research groups from the country. During the year, the project resulted in 10 collaborative research publications, 6 research publications, 1 book, training of 4 project students and 5 PhDs while 19 PhD students and 3 Post-Docs continued their research work.

Establishment of 3rd Detector of Laser Interferometer Gravitational-wave Observatory (LIGO) in Maharashtra

The Detailed Project Report for the project was under consideration and financial appraisal process advanced further during the year. In parallel, the project activities continued in full swing.

Indian Participation in Square Kilometer Array (SKA) project in South Africa and Australia

SKA is the upcoming largest radio telescope facility of the world. After successfully Indian participation in its design phase, the Detailed Project Report for India's participation in the construction phase was formulated and its appraisal process advanced further during the year.

Establishment of National Large Solar Telescope (NLST) in Ladakh

It was planned to establish a 2-metre solar telescope at Merak site in Ladakh. The process of financial appraisal of the project was in advanced stages.

2.4 Climate Change Programme (NMSHE & NMSKCC)

DST has been entrusted with the responsibility of coordinating two national missions on climate change as part of National Action on Climate Change (NAPCC). These are (i) National Mission for Sustaining the Himalayan Ecosystem [NMSHE] and (ii) National Mission on Strategic Knowledge for Climate Change [NMSKCC]. The Climate Change Programme (CCP) of Strategic Programmes, Large Initiatives and Coordinated Action Enabler (SPLICE) Programme Division is implementing these two national missions.

2.4.1 Major Achievements and progress during 2020-2021

New Initiatives

As part of implementing two missions under CCP following new initiatives/projects commence during 2020-2021

- i. Vulnerability and Risk Assessment for IHR:** Vulnerability indicates the parameters to which people or their valuable things are susceptible to and their adverse impact on climate change on different socio-economic and biophysical parameters. Scientists from IISc Bangalore, IIT Mandi and IIT Guwahati have developed a common frame work and methodology for assessing climate vulnerability of IHR in consultation with 12 State Climate Change Cells established by DST under NMSHE. The vulnerability profile developed by the Himalayan States has helped States to gain insight in aligning their developmental plans to climate change.

The first ever maps for the Indian Himalayan Region (IHR) at the sub-national and district level were earlier released by Honb'le Minister of S&T during the International Conference of the Parties(COP24) to the United Nations Framework Convention on Climate Change(UNFCCC) in a specialized session hosted by DST at Poland in December 2018 as a report on "Climate Vulnerability Assessment for IHR using common framework". This year, the work has further been taken up to develop the vulnerability profile at the three different levels such as:

- PAN-India State level
- PAN India-District level and
- Assessments carried out by all 12 Himalayan states (district level/block level/sectoral).

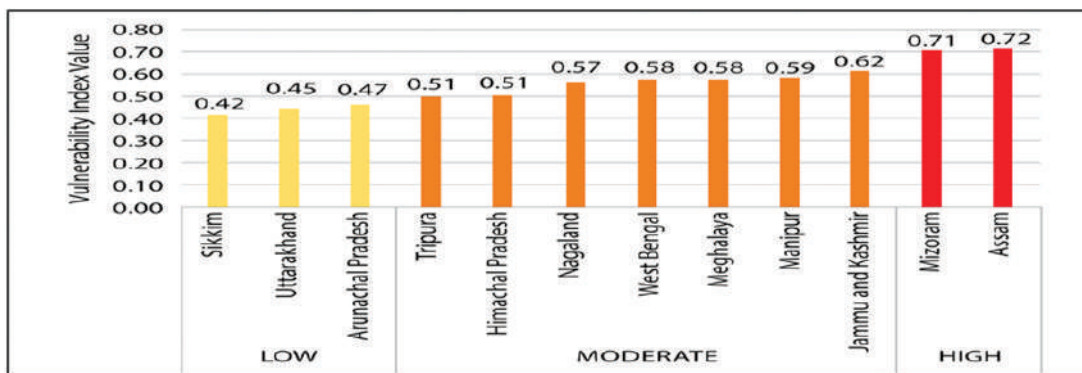

Fig: Vulnerability Index of IHR states using the common framework

A web based geoportal was launched which hosts the various vulnerability maps from the Himalayan region. The geoportal automates the process of map making based on the datasets provided by the States. The geoportal may be accessed at the following link: <http://himalayageoportal.in/>

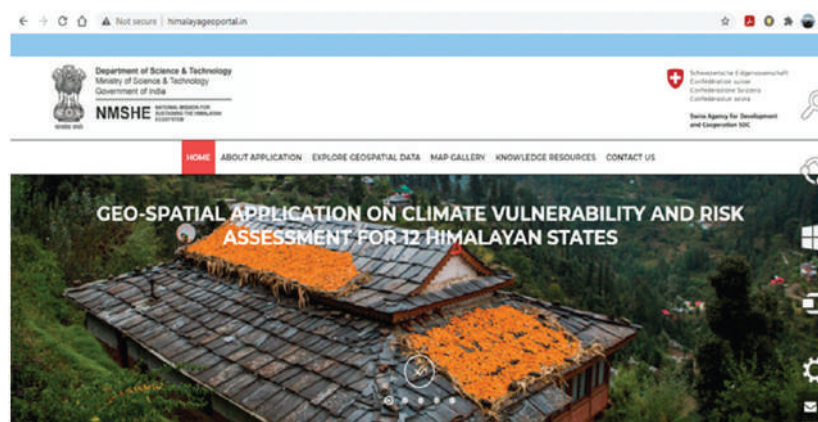

Fig: Web portal launched by DST

- Launch of 3 new Center for Excellences(CoEs) in IHR: Under the programme Human and Institutional Capacity Building Programme (HICAB) , 3 new CoEs were virtually launched by Secretary, DST. These Centers are positioned in three lead institutions working in different areas of Himalayan ecosystem at Kashmir University (Glacial studies in Western Himalaya) Sikkim University (Water Resources, Cryosphere and Climate Change Studies) and Tezpur University (Climate Change Impacts and Adaptation). More than 100 participants -students, research scholars and faculties from the host academic institutions and the State Government official attended the event.
- **Major R&D programme** : Research proposal on “ Impact of Climate Change on Water Resources of Arunachal Pradesh ” to be implemented by North Eastern Regional Institute of Science and Technology (NERIST), Arunachal Pradesh has been supported to study the Impact of climate change on hydrological regime and bioresources of glaciers, snow cover and lakes in alpine ecosystem, estimation of impact of climate change on water resources availability and Vulnerability assessment of floods and water quality due to climate change in Arunachal Pradesh.
- During the year , 4 Expert Committee (EC) meetings were organized to review the ongoing activities of the 13 Major R&D programme under NMSKCC missions and evaluate the new proposals received under NMSHE. Committee considered three new proposals for the next phase of Task Forces and recommended 7 new proposals for strengthening second phase of State Climate change cells in the States of Punjab, Tripura, Manipur, Himachal Pradesh, Jammu & Kashmir, Sikkim and Mizoram.

2.4.2 Significant outcomes from the ongoing programmes

Thematic Task Forces (TF) under NMSHE:

Task Force (TF) for Status of geo- resources and impact assessment of geological (exogenic) processes in NW Himalayan Ecosystem at Wadia Institute of Himalayan Geology, Dehradun has created an inventory of the glacial lakes and avalanches for the Bhagirathi basin. A total of 15 avalanche sites and 135 glacial lakes (area >500 m²) have been identified. Out of 135 glacier lakes, 130 have been classified as ice-dammed lakes (supra-glacial lakes), and only five are moraine-dammed lakes which are very small.

The Satopanth Lake (Moraine Dammed lake) is one of the lakes whose area is continuously shrinking. It is also observed that most lakes are supraglacial type and generally form over the glacier surface

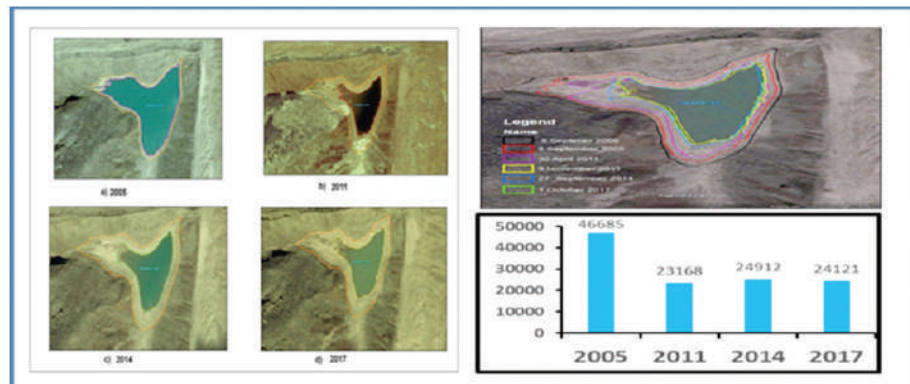

Fig: Temporal Changes in Lake Boundary (area) of Satopanth Lake between 2015 and 2017. The bar diagram is showing the reduction in lake water since 200

TF on “Integrated Hydrological Studies for Upper Ganga Basin up to Rishikesh” at National Institute of Hydrology (NIH), Roorkee has developed a detailed hydro-meteorological database for a watershed comprising of isotopic data of rainfall, snow, river flow, and groundwater (including springs) from more than 10000 samples; water quality observations at 15 locations in study basin; ecology/aquatic species observations in eight zones, water census data of around 200 villages, geo-tagging of cloud burst and extreme events in basin since 2010.

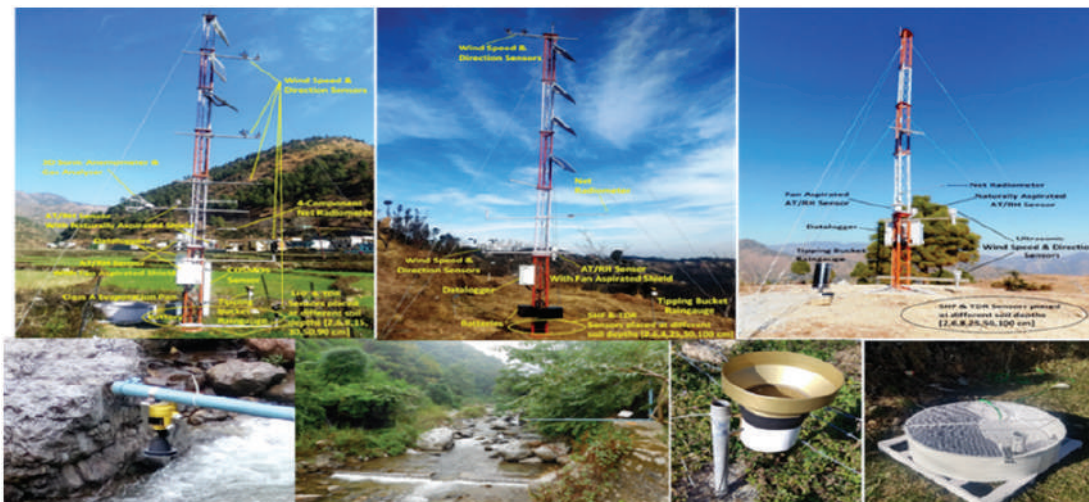

Fig: Instrumentation in experimental watershed

TF on Forest Resources and Plant Biodiversity at GBPNIHE, Kosi-Katarmal, Almora has developed a database of plants of the IHR in a standard format through a web portal www.ihrplantresources.com for the conservation and management planning. Inventory of trees, shrubs, wild edibles, alien plant species, lichens, threatened plants of the IHR has been prepared. Database on the biodiversity research for the Himalayan region also created.

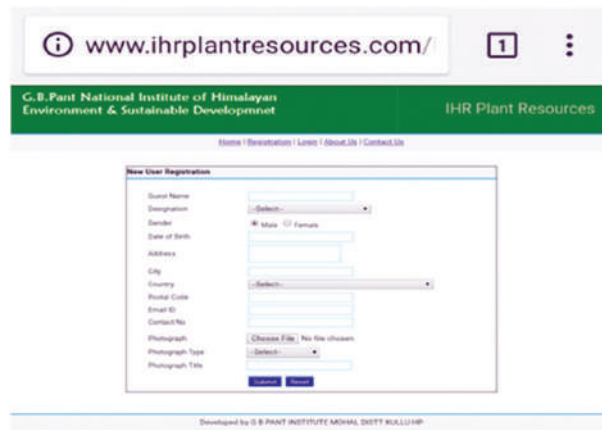

Fig: Web portal developed by TF www.ihrplantresources.com

In addition, the TF has established the Long-term Ecological Monitoring (LTEM) of forests in relation to climate change was established along the elevational gradient (900-3900 m). For the first time in India, two Global Observation Research Initiative in Alpine Environments (GLORIA) sites have also been established. The established LTEM plots may be helpful in detecting the changes and trends in forest composition, plant species richness and diversity, forest community structure with respect to environmental change over the years. The data generated from GLORIA sites have formed first of its kind baseline and will help in detecting the changes of vegetation diversity in sensitive alpine area in the IHR.

TF on Wildlife Species and Ecosystems at WII Dehradun has deduced Long-term monitoring (LTEM) plots for continuous data collection occurrence, richness and abundance patterns across three basins across the Himalaya (viz. Beas in north-west, Bhagirathi in the west and Teesta in the east).

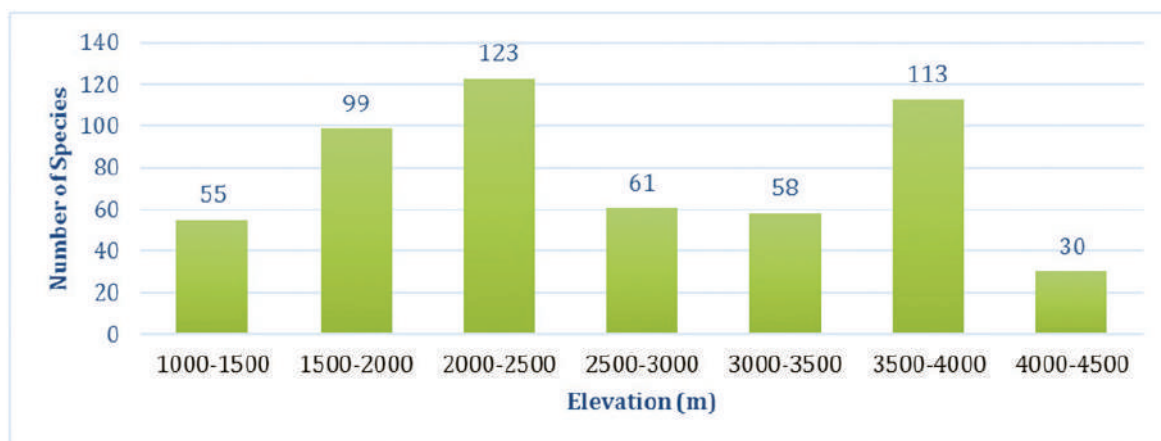

Fig: Patterns of lichen species richness along the elevation gradient in the study area (Beas basin Bhagirathi basin and Teesta Basin)

TF on Traditional Knowledge System (TKS), JNU New Delhi has created a database on the traditional conservation and utilization patterns of both wild and domesticated bioresources of most of the selected communities. A profile document of 30 selected communities highlighting their geographic distribution, population, religion, languages, major festivals, socio-economics, salient features of their TKS and the potential traditional practices (Indicative Best Practices) for up-scaling to broaden the range of livelihood options has been recently brought out.

TF on Himalayan Agriculture, ICAR New Delhi has worked in a climate smart manner in 15 pilot sites and 18 target intervention sites (TIS) ranging from 154 m asl in Nagaland to 4480 m asl in Leh. So far, the Task Force successfully introduced total 130 varieties of agricultural and horticultural crops and 17 breeds of livestock, poultry and fish breeds across the entire Indian Himalayan region at various pilot sites which has resulted in increased production and income of hill farmers.

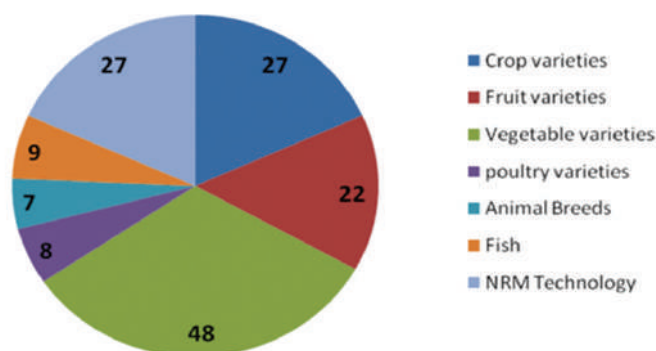

Fig: Total no. of interventions in pilot sites

2.4.3 Major outcomes from the ongoing programmes

Center of Excellence(CoE) on Climate Change Aspects

DST-ICRISAT Center of Excellence on Climate Change Research for Plant Protection (CoE-CCRPP): Pest and disease management for climate change adaptation: This specialized Center at ICRISAT,Hyderabad is created to develop a framework and create facilities for evaluation of climate change arbitrated pest &diseases complications. This multilateral research consortium works for pest risk mapping and forecasting under future climate scenarios, assessment of climate variability (e.g. temperature, CO₂ and rainfall) on population dynamics and host plant resistance under the changing climate scenario. The center is working on capacity building of various stakeholders on suitable plant protection and adaptation strategies for climate resilient agriculture and created a huge set of database to support pest and disease modelling and forecasting by gathering Historical pest and disease, insect-trap and weather information. Center has also develop a pest distribution maps indicating future pest and disease hotspots, risk maps and spatio-temporal dynamics with respect to climate change scenario. The CoE has set up State-of-the-art climate change

crop protection research facilities as well as created Web-enabled forewarning models developed for pigeonpea, chickpea, cotton and rice targeted pest and diseases.



Fig: Simulation Crop-Pest dynamics in Pigeon-pea

Web-enabled Insect-Pest Forewarning Systems: The user interface was developed to upload and visualise the historical insect-pests & diseases with corresponding weather data to predict the pest incidences at (i) crop age at first appearance of pest, (ii) crop age at maximum pest population and (iii) maximum pest population for real-time decision making.

DST-ICMR Centre of Excellence for Climate Change and Vector Borne Diseases at ICMR-National Institute of Malaria Research, New Delhi is using a multi-disciplinary approach (meteorology, epidemiology, ecology and modelling) to provide evidence-based research on climate change and Vector borne Diseases (VBD) transmission so as to guide the national programme. The main focus of the centre is to determine the temperature thresholds for survival of vectors of major Vector-borne diseases (VBDs), modelling of projected scenarios of the VBDs and to set up a system for early warning of outbreaks for malaria and dengue.

To understand the climatic thresholds of scrub typhus, ecology of Kyasanur Forest Disease, link between disasters and vector borne disease, developing capacity in climate change and VBDs and heading towards development of early warning system for malaria and dengue was studied. A bioclimatic model was developed to identify potential spatial distribution of Kyasanur Forest Disease (KFD) guiding the health authorities to keep a constant vigil in potential areas for monitoring of any monkey deaths in forested areas. Studies also revealed that extrinsic incubation period (EIP) for transmission of dengue vary from 5-50 days in tropical to temperate climatic locations based on prevailing temperature indicating that places with tropical climate are more susceptible to the disease. Places like Coimbatore are more suitable for dengue transmission than sub-tropical and temperate climatic. In collaboration with Indian Council of Medical Research(ICMR) e-governance division, a prototype of dynamic EWS web-based system has been created using different programming. Currently, the prototype has been developed at <https://egov.icmr.org.in/> website.

DST-Mahamana Centre of Excellence in Climate Change Research the center at BHU, Varanasi is envisioned to do standardization as well as quantification of impact and vulnerability assessment in water, agriculture and health due to climate variability and change and to understand the associated socio-economic implications. In addition, the center works to develop infrastructure facilities for climate research and a coherent multi-disciplinary problem-driven research group, manpower by strengthening teaching and training to build long-term scientific capacity and serve R&D needs. Studies were conducted on heat waves on different meteorological Subdivisions of India and it was observed that there is Spatio-temporal shift in the heat waves with prominent increase over north-western, central, and south-central India, while a significant decrease over Gangetic West Bengal. Daily mortality owing to heat waves is higher than cold waves with central Gangetic plain being maximally affected.

Crop simulation models predicted a large decline in sugar content of Sugarcane crop due to increase in temperature, rainfall and solar radiation in different climate change scenarios particularly in Bundelkand zone and Bhabhar and Tarai zone. Banana (*Musa spp.*) plants showed burning effect due to heat waves. The high-resolution soil moisture sensor developed by merging different satellite sensors which recommended for use in crop monitoring and insurance policy. Prototype of Irrigation scheduling is now developed for android phone usable for Varanasi. In capacity building program several young professionals and students gets hands on training on simulation modeling. The efforts so far lead to few publications in high impact international journals.

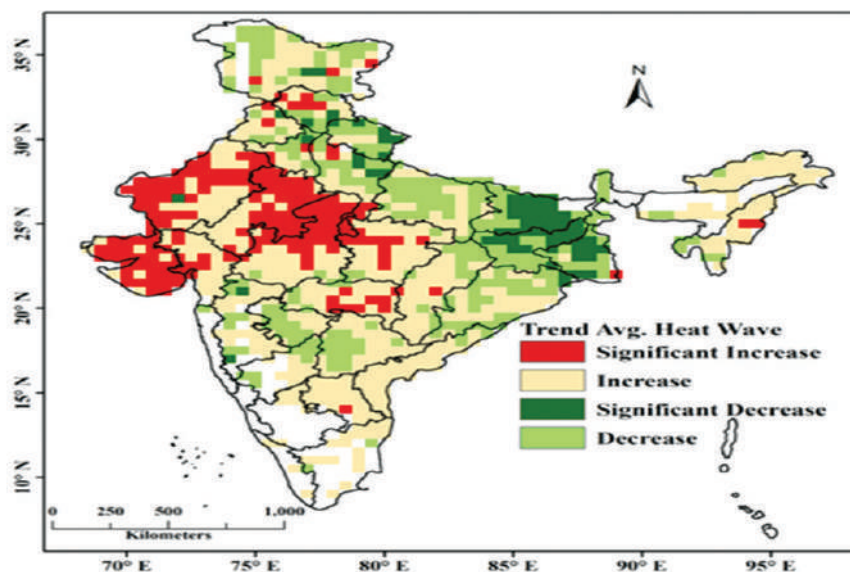

Fig. Long term trend in Seasonal Heat Wave during 1951-2016 (March-July)

DST Centre for Excellence in Climate Studies, IIT Bombay

DST-CoE CS, IIT Bombay is established for steering high-impact research in the field of climate science and policy. Centre developed first ever Irrigation module for India which is freely downloadable for public. Cartographic national-scale products like Agricultural risk maps and maps of social vulnerability to hydroclimatic extremes have been developed. The existing database of microwave brightness temperature is presently being structured with respect to existing satellite missions for India using first-of-its-kind microwave L band radiometer. A decision support system for technology adoption in transport & power sectors based on system dynamics is being developed. Attribution analysis is being performed that will help in augmenting disaster databases on losses specific to anthropogenic climate change and Real-world fleet emission factors for carbonaceous aerosols is being developed to reduce uncertainty in vehicular emissions. 12 high quality climate change professionals are being specially trained in second phase at IIT Bombay through one-of-its-kind interdisciplinary PhD programme in Climate. The efforts so far have led to a total of 18 publications in highly reputed international journals, 17 proceedings in international & 9 in national conferences have published. 2 summer schools, 3 workshops and 1 e-school on climate science and policy were organized.

DST Centre of Excellence at IIT Kharagpur

The Taylor skill of best-performing 14 Global Circulation Model (GCMs) participating CMIP5 and 20 GCMs from CMIP6 are being used for the inter-comparison exercise. The best performing models selected from CMIP5 family represents the category having a good correlation of 0.7 to 0.9 and RMSE of 0.8-1.7 m/s when compared with ERA-Interim and Scatterometer data. The comparison with CMIP6 GCMs reveal that NorCPM1 is found to be the least correlated amongst the 20 models. The remaining models in CMIP6 family has a correlation ranging between 0.7 to 0.9 similar to CMIP5. The correlation coefficient obtained by comparing with scatterometer winds are relatively lower than that obtained by comparing with ERA-Interim winds. It is noteworthy from comparison analysis that a greater number of CMIP6 models fit into correlation range of 0.8-0.9 and RMSE of 1.0-1.5 m/s than CMIP5 models. Also, there is a need to verify the expected improvements in the CMIP6 models as compared to CMIP5 models on spatial scales. The time series comparison of wind speed datasets also obtained from individual models of CMIP6 family, MMM (Multi-Model Mean) based on the best performing models, against the RAMA buoy observations. Analysis reveals that maximum deviation in the GCMs (Global Circulation Models) are observed during the summer months of 2010, and thereafter the MMM closely follows the observations reasonably well. From these several proven methods, CMIP6 models and MMM constructed from the best-performing models are suitable for investigating the projected wind speed patterns over the Bay of Bengal region.

CoE- Divecha Centre for Climate Change

To study the impact of climate change on the glaciers in the Himalayas, impact of anthropogenic aerosols on climate of the stratosphere and developed climate models for understanding past and future climate change, this centre was established at Divecha Centre, IISc Bangalore. A new technique based upon surface velocity was developed to estimate glacier depth. This method was used to estimate glacier stored water and hence the influence of climate change on water security of small mountain communities in the Himalaya. The study shows that an increase in solar radiation by 15% after the last glacial maximum led to an increase in Indian rainfall by 100% on account the role played by the increase in water vapour during deglaciation. The ability to absorb light by Brown Carbon transported from Indo Gangetic basin to Indian Ocean is lower than previously thought. This implies that the previous estimates of global warming caused by Brown carbon may be too high.

Major R&D Programmes (MRDPs)

As part of NMSKCC deliverables, DST has supported 23 Major R&D Programmes at key knowledge institutions and universities in different areas of climate science and adaptation which are in different stages of progress. Some of the achievements under the program are:

Reversing Climate Change via Geoengineering: Impacts on Developing Countries like India”, IISc. Bangalore

Under the project, the climatic effects of sulfate aerosol geo engineering to the latitude and altitude of the aerosol layer, and the size of the aerosol particles are investigated using a comprehensive coupled atmosphere-ocean model. This study showed that Sulfate aerosols in the stratosphere are more effective in cooling the climate when they reside higher (~25 km) in the stratosphere, Hygroscopic growth of sulfate aerosols in the lower stratosphere causes an increase in cooling efficiency and The Indian summer monsoon precipitation decreases and droughts are more likely when aerosols are injected into the northern hemisphere stratosphere.

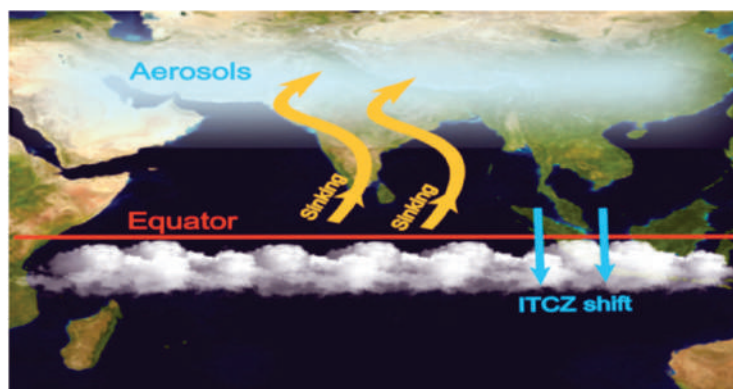

Fig Schematic diagram illustrating the impact of sulfate aerosol injection on the Indian monsoon precipitation

Study of the Effects of Climate Change on Hydro-meteorological Processes: Droughts and Floods at Different Spatial and Temporal Scales in Eastern India”

is for the climate change impact assessment on hydro meteorological extreme events in the Eastern India region comprising of the states of Odisha, Jharkhand, Chhattisgarh and south-east Bihar at Rice Research Institute Cuttack. Regional meteorological drought SDF curves developed for different return periods (for the homogeneous regions in Eastern India) suggest increasing drought severity in future time periods and an improved retrieval algorithm for high resolution soil moisture over challenging paddy-dominated regions of Eastern India is developed. High-resolution soil moisture (1, 3 and 9-km) products that could be used for water balance and drought modeling are developed by merging of NASA’s SMAP and ISRO’s RISAT-1 satellite observations.

7. National Network Programme on Aerosols

As part of NMSKCC deliverables, DST has supported 8 Aerosols projects at key knowledge institutions and universities in different domains of climate science and adaptation which are in different stages of progress. Outcomes of few projects are as follows:

- The Himalayan Cloud Observatory (HCO) established to take ground-based observation of the Aerosols, Cloud condensation nuclei (CCN) particles and meteorological Parameters (Automatic Weather Station) over the Garhwal Himalayan region of Uttarakhand to understand the complex mechanism of cloud formation, rainfall and climate change in the sensitive Himalayan region of Uttarakhand in different season and different climatic condition.
- Chemical composition and source apportionment of aerosols using receptor models at urban sites of the Himalayan region of India has been studied in which the ambient air quality of the Himalayan region of India and its impact on climate change, a source apportionment study of aerosols (PM_{10} and $PM_{2.5}$) is initiated to identify the possible potential sources over the region and receptor modeling has been employed for identification and quantification of PM_{10} and $PM_{2.5}$ sources. $PM_{2.5}$ and PM_{10} samples were collected periodically during 2018-2019 at Kullu, Nainital and Darjeeling of Himalayan region of India which identified the contribution of crustal/soil dust, biomass+coal burning, vehicular emissions, solid waste burning and industrial emissions to the $PM_{2.5}$ and PM_{10} mass over the region.

State Climate Change Cells (SCCC)

One of the objectives of National Mission is to build S&T capacity in the areas of climate change at the State level. So far DST has set up SCCC in 25 states out of which 12 are in Himalayan States under NMSHE and 13 in non- Himalaya States under NMSKCC. These State Climate Change cells have been established in the State Government’s nodal departments designated to implement State Action Plan on Climate Change(SAPCC). During the

year, State Action Plan on Climate Change were revised in light of the India's Nationally Determined Contribution. These centers have been assigned to undertake following major tasks:

- Vulnerability and risk assessment at district/sub-district levels
- Institutional Capacity building and R&D for data base/ Information generation
- Training programmes for stakeholders, and.
- Public awareness as per the requirements of state and national action plan on climate change.

State Climate Change Cell at Madhya Pradesh: The centre has published 16 papers in Hindi and English languages. Organized 39 training programs & workshops, 70 programs, events & conferences in the area of climate change adaptation. The centre has received the honour as the First Prize Winner of National Water Mission Award 2019 for State level Climate Change Vulnerability Assessment study for Madhya Pradesh by Ministry of Jal Shakti, Govt. of India and First Prize Winner by Times of India sponsored Earth Care Award 2019 for Leadership in Urban Climate Action category. They developed an interactive & bilingual knowledge portal for disseminating climate change related information with URL www.climatechange.mp.gov.in

State Climate Change Cell at Punjab: Punjab Climate Change Knowledge Centre (PSCCKC) had undertaken multifarious initiatives to address climate change concerns. In Capacity building program, centre has trained more than 5 lac school students through Eco-games, interactive Quiz, visits etc. Organized 81 workshops to build capacities of Govt. Officers, women, NGOs, media professionals, farmers, industrial workers with total outreach of more than 1.5 Lakh. Promoted cleaner technologies in MSMEs to direct reduction in health vulnerability of around 25,000 industrial workers through improvement in work environment. Received SDG Action Award 2020 for 'Environment Sustainability' instituted by UNDP and Govt. of Punjab in recognition of works undertaken for enhancing State's climate change resilience capacity. The SCCC received best State award from Union HRD Minister for promoting environmental auditing in Schools. Designed and demonstrated climate resilient cattle sheds in collaboration with GADVASU, the partner knowledge institution. First-of-its kind Paddy Straw briquetting plant setup with funding under Climate Change Action Plan.

State Climate Change Cell at Karnataka: The centre for climate change at EMPRI has developed a Green Index Tool Kit and Portal which provides guidelines and methods to assess/audit Environmental Performance of Developmental and Infrastructural programmes/schemes of the government of Karnataka. The centre has created state of art climate change laboratory for research studies on climate change. The laboratory is under the process of ISO 9001 & OHSAS 18001 recognition. Butterfly monitoring program is launched in 2018-19 for Karnataka as a citizen science program for database of butterflies in the different districts of Karnataka and monitor as an indicators of climate change. Developed an interactive web portal <http://skccempri.karnataka.gov.in>. and android based mobile app (BIA) for identification of

butterflies in the field. The centre organized an international virtual conference on biodiversity and ecosystem services in a climate change perspective which is attended by more than 100 participants.

2.5 National Supercomputing Mission

National Supercomputing Mission (NSM) is jointly steered by Ministry of Electronics and IT (MeitY) and Department of Science & Technology (DST) and being implemented through two leading organizations – Centre for Development of Advanced Computing (C-DAC), Pune and the Indian Institute of Science (IISc), Bengaluru with an objective to meet the increasing computing demands of the scientific and research community. The NSM envisages attaining leadership in supercomputing, by creating a national infrastructure of supercomputing systems and facilities of different size and scale distributed across the country, developing supercomputing applications in scientific and engineering domains, training manpower in HPC areas, and initiating R&D activities in HPC systems (hardware and system software development). Multiple supercomputers of varying capability, ranging from a few 100 Tera FLOPS to Ten's of Peta FLOPS would be set up across the country under the National Supercomputing mission (NSM). C-DAC and IISc, Bangalore are the implementing agencies of the Mission.

2.5.1 Achievements and Activities under NSM

One of the major achievements of National Supercomputing Mission is the PARAM-AI 100 PF system that was placed at 62nd position in the TOP 500 Supercomputer systems globally in November, 2020. It has 5.3 PF sustained peak. It is the first HPC-AI system from India to have been placed in the top 65 globally. This system was funded supported under NSM and is installed at C-DAC, Pune.

The activities under NSM can be classified into four major verticals– NSM-Infrastructure; NSM-Research & Development; NSM-Applications Development and NSM-Human Resources Development. The status of various projects/ activities approved under these four verticals are as follows:-

- During last year, under NSM, two Supercomputers were installed and operationalized at IIT-Kharagpur named “PARAM SHAKTI” with 1.66 Rpeak (Theoretical Peak floating-point performance) with 850 TF (CPU nodes) and 195 TF (GPU nodes) capacity and the another supercomputer at IISER, Pune “PARAM Brahma” with indigenously designed cooling system by C-DAC (DCLC). During 2020-2021, Under NSM Phase-II, one system of 1.3 PF (1.6PF Peak) at IIT Kanpur and two systems of 650 TF (800TF Peak) each at JNCASR Bangalore, and C-DAC Bengaluru are commissioned. High Performance Computing (HPC) systems under Phase II were developed under ‘build approach’ and realized the ‘Atmanirbhar Bharat’
- 6 projects were sanctioned earlier in Applications Development area like Flood warning

and prediction, Drug Discovery, Computational Chemistry, Oil exploration etc. The progress of these projects is being monitored by respective Project Monitoring Committees and NSM-Technical Advisory Committee.

- In addition to the ongoing 3 projects in R&D, a call has been made for proposals on “HPC Applications Development” and “R&D leading to Exascale computing”.
- The NSM-Executive Board (NSM-EB) had approved setting up of NSM nodal centres for training in HPC and AI at IIT Kharagpur, IIT Madras, IIT Goa and IIT Palakkad which have started functioning. This year various training course were conducted through online platform to train manpower in various aspects of HPC. Two online Open ACC boot camps and annual Open ACC hackathon were conducted.

2.5.2 NSM-Infrastructure

On successful installation of PARAM Shivay (800 TFLOPS) at IIT BHU, PARAM Brahma (800 TFLOPS) at IISER Pune, PARAM Shakti (1.6 PFLOPS) at IIT Kharagpur during 2019-20, C-DAC installed HPC systems under Phase II of National Supercomputing Mission (NSM) funded jointly by DST and MeitY, Government of India. The HPC systems across three phases of NSM cater to computational demands of academia, researchers, MSMEs, and startups in areas like oil exploration, flood prediction and drug discovery among many others of national importance.

More than 10 Lakhs supercomputing application jobs are executed on systems installed at IIT BHU, IIT Kharagpur, IISER Pune and JNCASR Bengaluru by more than 700 users across the country till date.

On October 12, 2020, in presence of Shri Sanjay Dhotre Hon'ble MoS for MeitY, Education and Communications, Government of India, Memorandums of Understanding (MoUs) were signed by the Director General, C-DAC with Directors of IISc Bengaluru, IIT Kanpur, IIT Roorkee, IIT Hyderabad, IIT Guwahati, IIT Mandi, NABI Mohali, NIT Trichy and IIT Gandhinagar for establishing supercomputing facility under NSM, at these institutes.

MoUs were also signed by Director General C-DAC with Directors of IIT Kharagpur, IIT Madras, IIT Goa and IIT Palakkad for NSM Nodal Centre for training in HPC and AI, at these institutes.

Under NSM Phase-II, C-DAC has commissioned one HPC system of 1.3 PF (1.6PF Peak) at IIT Kanpur and two HPC systems of 650 TF (800TF Peak) each at JNCASR Bengaluru and C-DAC Bengaluru. The installation work is in progress for six systems of 650 TF (800TF Peak) each at IIT Hyderabad, IIT Guwahati, IIT Gandhinagar, IIT Mandi, NIT Trichy, NAABI Mohali and one system of 1.3 PF (1.6 PF Peak) at IIT Roorkee and one system of 2.6PF (3.2 PF Peak) at IISc Bengaluru. Cumulative compute capacity of HPC systems installed under Phase I and II is 16.6 PF. The systems were installed with C-DAC's System software

stack comprising C-Chakshu, CHReME, Ganglia, Nagios, XDMoD, OSTicket, OpenHPC, Lustre, PARView, MVAPICH2, Intel Cluster Studio, GNU Tools, CUDA Toolkit and others. A wide range of HPC applications, from various scientific and engineering domains, were made available on these HPC systems, which are optimized for the underneath architecture. The said HPC facilities installed under Phase I and II along with HPC systems under Phase-III are targeted to be accessed by around 75 institutions and thousands of active researchers, academicians on National Knowledge Network (NKN) - the backbone for supercomputing systems.

With convergence of HPC and Artificial Intelligence (AI), a 100 AI PF Artificial Intelligence supercomputing system has been designed, developed, and installed at C-DAC Pune under this Mission. It allows to handle exceptionally large-scale AI problems increasing the speed of computing-related to AI by several times.

For exploration of different emerging processors for development of future HPC systems, C-DAC has developed 100TF entry level systems around latest AMD and ARM processors. In the past, it has developed 100 TF systems around Intel Xeon Skylake and IBM Power 9 processors.

2.5.3 NSM-Applications

MeitY and DST has sanctioned 6 projects in Applications Development which are in progress. The areas in which the projects have been sanctioned are as follows:

- Flood Early Warning and predictions systems for River basins in India
- HPC Software Suite for seismic imaging to aid Oil and Gas exploration
- Urban modelling development of Multisectoral simulation lab and Science based Decision Support Framework to address Urban Environmental Issues
- Application sporting, scaling and optimization services
- NSM Platform for Genomics and drug discovery
- Materials and Computational Chemistry

For 'Early Warning System (EWS) for Flood Prediction in the River Basin of India', C-DAC has collaborated with Central Water Commission (CWC), IISc Bangalore and PEC Chandigarh. During May – October 2020, it conducted daily flood prediction (5-day simulation) with actual/ predicted data for Mahanadi Delta (9225 sq km) on its software (implemented using ANUGA Hydro) running on NSM Supercomputing infrastructure. It proved various concepts of ingestion of data from multiple sources and making available simulated output for select locations for CWC to validate on the ground. Data and parameters, viz. rainfall, roughness, tidal, barrage discharge used in

the model underwent extensive pre-processing and critical analysis. Differential mesh was explored to improve mesh resolution and to meet the timing requirements within the existing constraints of NSM infrastructure. The best simulation time achieved so far has been 4 hours for a 5-day simulation with 900 sq m mesh resolution for delta region. The prevailing pandemic during the year limited the field visits for calibration and validation of simulated outputs.

In the project 'Development of multi-sectorial simulation lab and science-based decision support framework to address urban environment issues', C-DAC has collaborated with multiple institutions including IIT Bhubaneswar, IISc Bangalore, IITM Pune. The objective of this project is to develop an online fully coupled urban' meteorology and hydrology, CFD, and air quality' modeling system to capture the urban representation of micro scale city environmental conditions. During 2020-21, it carried out sensitivity studies, air quality forecast research & real time air quality, coupled hydrology for urban modelling and CFD simulation of atmospheric flows & pollution dispersion for urban modelling on NSM infrastructure.

Under the project for development of 'HPC software suite for seismic imaging to aid oil and gas exploration', C-DAC is collaborating with IIT Roorkee, Osmania University Hyderabad, NGRI Hyderabad, ONGC Dehradun. In this project, C-DAC is developing a parallel 2D & 3D acoustic based RTM (reverse time migration) software suitable for state-of-the-art hybrid computing platform. Seismic migration is the key technology for producing optimal image of earth subsurface containing complex geologies like salt bodies, folded sedimentary layers or faulted structures.

2.5.4 NSM Research and Development

MeitY and DST has sanctioned 3 projects in R&D. These projects are as follows:

- Design and development of Direct Contact Liquid Cooling system (first version implemented at IISER, Pune – Param Brahma Supercomputer)
- HPC Applications framework – IIT-Chennai, IIT-Mumbai and IISc-Benagaluru
- Programming Model, Language and Compilers for emerging HPC systems

For 'Design and Development of Direct Contact Liquid System (DCLC)', C-DAC is collaborating with IIT Mumbai to validate the cooling technology solutions developed by IIT Mumbai for large scale HPC system by experiments and CFD analysis. The objectives of the project are to design a modular PWC_A&EC (Panel Water Cooler with Provision of Air and Evaporative Cooling) and to demonstrate the effectiveness of this technology to handle 30 kW heat load generated from a DCLC based HPC system. The other objectives are to design a modular Coil On-Chip Liquid Cooling System, (COC_LC) and to demonstrate the effectiveness of this technology to handle heat load from 180W to 360 W from a HPC server. During the year, it has developed a CFD model for two tubes and three tubes in a channel and carried out a CFD simulation study.

In order to harness the vast supercomputing computing resources provided under NSM, to develop applications to tackle a broad spectrum nationally relevant and internationally competitive problems of unprecedented complexity working at peta and exascale and also to take the nation to the exascale era, it has been decided to initiate R &D projects across the country. A call for proposal on “HPC Applications Development” and “R&D leading to Exascale computing” were made.

The main focus areas are as follows but not limited:

- to build capabilities to tackle problems that are currently out of reach either for want of newer physics or newer algorithms
- to focus on the use of machine learning and large scale data analytics at exascale level
- to develop new programming models that scale well at exascale architectures
- to develop popular application packages at peta and exascale level
- to build newer class of processor architecture and interconnects.

The R&D activities/project proposals that are sought through this call would be broadly in the areas of

- HPC Applications
- Scalable Algorithms and Libraries
- HPC System Software and Data Management
- Hardware System Architecture
- Enabling Technologies
- Data Centre Infrastructure
- Cross-cutting issues spanning across the above

2.5.5 NSM-Human Resources Development

As approved by NSM-Executive Board last year, NSM nodal centres for training in HPC and Artificial Intelligence (AI) were established at IIT Kharagpur, IIT Madras, IIT Goa and IIT Palakkad. Considering the pandemic situation in this year, these four nodal centres together have launched an online course in Basics of HPC. This course is planned for 13 weeks (3 months) and will have 40 live lectures of 1 hour each, followed by Q & A session. The faculty for this course is from IIT Goa, IIT Palakkad, IIT Tirupati, IIT Kharagpur, IIT Kanpur, Nvidia and C-DAC. Subsequently, recorded lectures are made available for off-line viewing. Topics include theory of various parallel programming models and demonstration

of parallel programming coding. An examination will be conducted at the end of the course, leading to certification. IIT Madras has offered credits to students, who complete this course, successfully. This year, 803 participants are attending this course.

A 5 day HPC Workshop for users of PARAM Shivay was conducted at DST-CIMS, BHU in January 2020. 52 participants from 15 departments attended this workshop, which included, Genetics and Plant Breeding, Farm Engineering, Computer Science, GEOPHYSICS, Civil Engineering, Mathematical sciences, Chemistry, Physics, Chemical Engineering, Humanistic Studies, School of Biomedical Engineering, Centre for Interdisciplinary Mathematical Sciences, Statistics and Institute of Environment and sustainable development.

Thirty five students attended the February 2020 batch of 6 month PG Diploma in HPC system administration and 33 students are attending PG Diploma in AI. A two day Open ACC Boot camps were conducted in February 2020, at Institute of Plasma Research, Ahmedabad and at IIT Kanpur. These were attended by 75 participants. Boot camps at IIT Madras and IIT Kharagpur scheduled in April 2020, had to be cancelled due to pandemic situation. Two online Open ACC boot camps were conducted which were attended by 184 participants.

The annual Open ACC hackathon to improve performance of codes was conducted in online mode from August 31, to September 9, 2020. 10 teams with 37 participants attended this event. The teams were from Indian Institute of Science, IIT Madras, IIT Kharagpur, Institute of Plasma Research, Ahmedabad and BITS, Hyderabad. These teams were mentored by 22 experts. Speedup ranging from 2 times to 15 times on their respective codes, was achieved by these teams successfully.

2.6 *Technology Fusion & Applications Research (TFAR) Programme*

Technology Fusion & Applications Research (TFAR) Programme is meant to boost research in emerging technologies under single platform. The TFAR programme, a national initiative with Pan India applicability is being implemented by the Department of Science & Technology (DST) at a total outlay of Rs 250 Crore for a period of three years. The programme will boost research for fusion, convergence and application of emerging technologies like Quantum Enabled Science & Technology, Network Project on Imaging Spectroscopy and Applications (NISA), Epidemiology Data Analytics and Indian Heritage in Digital Space. The programme is being operated in the knowledge generation domain, and its beneficiaries are slated to be mainly researchers, scholars and students. However, the technology outcomes and innovations could lead to start-ups and technology-driven economic growth. Such technologies would be of benefit for the general public. A slew of advanced technologies is shaping our lives, arguably at a rate of change never seen before. However, no single technology vertical can address or solve challenges that we face today. The fusion and convergence of various technologies is the need of the day. TFAR is being implemented by the FFT Division, DST.

All the advanced technologies in TFAR programme are continually evolving beyond the

boundaries of single disciplines, thereby generating innovations. Resulting patents can feed into a Start-up ecosystem and help employment generation. It can also create specially trained human resource & skilled workforce. These technologies are highly prominent today and compiling them on one platform could serve those engaged in R&D, translational research, policy and technology management, and accelerate the process of technical developments and societal problem solving. The TFAR programme would also establish outcome-based research collaborations within India and with International academic institutions for the advancement of interdisciplinary research in the country.

Following are thematic research areas under TFAR:

- a. Quantum Science & Technology Research Initiative (QuSTRI)
- b. Imaging Spectroscopy & Applications Research Initiative (ISARI)
- c. Epidemiology Data Analytics Research Initiative (EDARI)
- d. Indian Heritage in Digital Space Research Initiative (IHDSRI)
- e. Cyber Physical Systems Research Initiatives (CPSRI)
- f. Data Science Research Initiatives (DSRI)
- g. Internet of Things Research Initiatives (IoTRI)
- h. Cyber Security Research Initiatives (CSRI)

2.6.1 Quantum Science & Technology (QuST)

The research in Quantum field would lead the development of quantum computers, Quantum Communication, Quantum Key Distribution, Cryptography and Cryptanalysis. Quantum computing, the next generation computational paradigm, has many applications like drug discovery, nuclear research, space applications, Numerical weather predictions, aerospace engineering and many advanced Science & engineering areas. The advancements in Quantum Communication and Cryptography provides us with an edge in safeguarding our critical communication networks; protect our critical infrastructure, financial networks and services. Technology development in both fibre-based and free space communication technologies are envisaged in this initiative. 51 projects in a networked mode have been supported so far.

Expected outcomes:

- Development and demonstration of 8-Q-bit quantum computers, Communication (Fiber & Free Space) & Cryptography
- Development of application specific quantum-algorithms.

- Development of advanced mathematical quantum techniques, algorithms and theory of quantum information systems.
- Also, 100 PhD's in the Quantum field, training to 2000 Undergraduate, Post Graduate and Scholars in the advanced algorithm and application development using quantum systems.

2.6.2 *Imaging Spectroscopy & Applications Research Initiative (ISARI)*

This area of research has potential to develop technologies for national issues like mineral exploration, water quality estimation & quantification, forest growth, crop loss assessment, pollution estimation and so on. Applications like soil health cards, management of emissions, crop health monitoring, river rejuvenation and other spatio-temporal analysis require research in advanced remote sensing technologies. Imaging Spectroscopy is an emerging area and the government has recognized its potential.

This programme aims at developing newer imaging technologies for applications in various fields (such as defence, agriculture, mineral exploration, pollution etc) involving spectroscopy and optical imaging. In all about 36 Principal investigators and 72 Research Fellows are part of this programme and represent different GOI organizations and academia's are part of this programme. In this programme which is about to conclude following major objectives are achieved.

- Establishment of spatio-spectral database from field, air, and space borne platforms and augment scientific understanding on imaging spectroscopy in the chosen fields of research namely Defense & terrain, Agriculture, snow & ice, water Geology, forestry.
- An in-house software for hyperspectral data processing, analyses and retrieval of parameters of interest like plant health, water quality, forest productivity, mineral exploration etc.
- Developing methodologies and transfer of understanding to Technology Incubation Hubs
- Development of augment human resources
- Establishment of sophisticated analytical equipment facilities for end-to-end research involving imaging spectroscopy.

Major Achievements

- Establishment of one of the biggest reflectance spectral database (reflectance) with about 3000 well characterized, unique spectral and attribute data.
- Hyperspectral software for basic and advanced processing and parameters retrieval
- Capacity building among 36 Principal Investigators and About 70 young individuals who are in different stages of completing their PhD

- Development of application Methodologies/techniques involving spectral imaging in areas like off-road trafficability, plant health, snow characteristics and avalanche prediction, water quality, forest productivity etc.
- Online web portal and database management system
- Establishment of the state of the art instrumentation facilities
- About 100 Research Publications
- Conducted a Training Programme on Hyperspectral Remote Sensing

Publications:

Journals : 60 Conferences: 60



NISA X-Ray Fluorescence Spectroscopy Facility at IIT Bombay



NISA IOP Profiler collecting data in Chilka Lake, Orissa



NISA Hyperspectral Core Logger (To be patented) logging drill core samples for Uranium exploration



NISA Web-portal cum Database management System ([www. http://nisa.geos.iitb.ac.in/](http://nisa.geos.iitb.ac.in/))

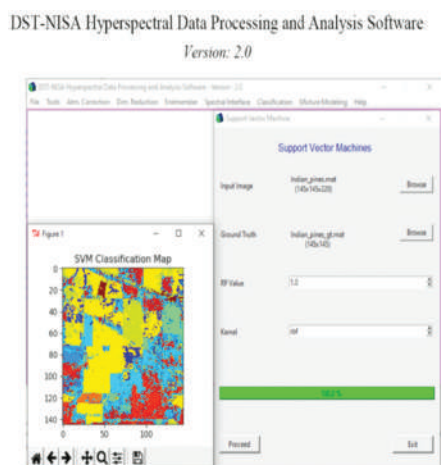

NISA PAMC with Prof. Dhadhwal, Dr. K.R.Murali Mohan and other members

2.6.3 Epidemiology Data Analytics Research Initiative (EDARI)

This area aims to create a scalable data-oriented open platform for public health epidemiology in India and to gain a systems view of the spectrum of population health challenges. EDA programme will identify, collate, clean and analyse diverse data that reflect the health of a larger rural or urban population in varied locations across India. It will also create the digital platforms and tools that enable such work. It will also lead to the creation of an open public health data platform with built-in tools for epidemiology data analytics, visualisation and analysis.

Expected outcomes will be a Health Data Analytics technology platform. Nearly 10 projects in a networked mode were supported so far.

2.6.4 Indian Heritage in Digital-Space Research Initiative (IHDS)

The Department of Science & Technology (DST), Government of India, has invested in promoting Indian cultural heritage, its preservation and presentation to the world by sponsoring technology-based projects under the scheme 'Indian Heritage in Digital Space'. These initiatives of the DST are supported by the Prime Minister's Office (PMO) as they align with the Digital India programme of the government. With this scheme, DST has tried to showcase how indigenous, home-grown talent in India, supported by the Government, can offer innovations which can match and even surpass many global initiatives. The cutting-edge technologies being developed and tested in these projects will have a positive impact to global efforts being done in the digital preservation and archival of world heritage sites.

The foundation to these projects was laid by the Indian Digital Heritage (IDH) project, which was a unique initiative of the Department, supporting collaborative projects between researchers in the areas of technology and humanities for the digital documentation and interpretation of

our tangible and intangible heritage. The Indian Digital Heritage project highlighted the art, architecture and cultural legacy of the UNESCO World Heritage site of Hampi in Karnataka, the medieval capital of the Vijayanagara dynasty. Around 27 national institutes, academic and other research organizations participated in this endeavour which came to a successful conclusion in 2016.

The goal of the IDH Research Project (www.digitalhampi.in) was to extend the power of digital technologies to well beyond monuments to art, architecture and all forms of cultural and historical knowledge. The aim of the project was to go beyond simply storing and sharing the heritage data and knowledge and use emerging technologies to create vivid experiences of the heritage for common users. IDH initiative gave birth to some of the most advanced techniques and technologies in digital heritage preservation. As part of this initiative, around 37 new technologies were developed and 7 prototypes were demonstrated. A book “Digital Hampi: Preserving Indian Cultural Heritage,” containing the details of research outcomes of these initiatives, has been published by Springer (<https://www.springer.com/in/book/9789811057373>), and was launched by the hon’ble Minister for Culture and Tourism in January 2020.

Implementation of IHDS projects:

DST has invested in a deliverable based directed research programme called “Indian Heritage in Digital Space” (IHDS). Under this initiative, there are two projects related to further enhancement of the IDH technologies. The implementation of these projects has been done by a tech team at IIT Delhi, and other collaborating partners such as IIT Bombay, KSCST, NID Bangalore and CSIR-CBRI Roorkee. The tech team at IIT Delhi includes a tech startup company incubated at TBIU, IIT Delhi - Vizara Technologies Private Limited, which has been the implementing agency for the project, providing knowledge-based Virtual reality and Augmented reality solutions in various domains with a special focus on heritage preservation in digital space.

IHDS PROJECT-1: The five Monument Project

TITLE: Augmented Reality based Interactions with Physical Models of Monuments

DST 5 Monument Project



Kashi Vishwanath



Taj Mahal



Hazara Rama Temple



Rani Ki vav



Sun Temple

One of the outcomes of the IDH project, ready for productizing was the technology to produce a 3D printed replica of a monument with a Mixed reality interface for a virtual walkthrough called a **ViRaasat** installation. Considering its novelty, the PMO directed DST to carry out a similar exercise on 5 monuments selected from across the country. The project was done by the premier Indian academic and research institute – the Indian Institute of Technology Delhi, partnering with CSIR-CBRI Roorkee and a tech startup Vizara Technologies as the implementing agency.

The monuments were selected based on the diversity of India and the fact that the 3D data of monument sites were available with different government agencies. The five (5) Indian monuments, out of which four (4) are UNESCO World Heritage sites are the Kashi Vishwanath temple, Taj Mahal, Sun Temple Konark, Ramachandra Temple at Hampi and Rani Ki Vav, a stepwell in Gujarat. The technologies that were used in the project include Laser scanning, 3D modelling to create high-quality 3D Digital models of the Monument, 3D printing to develop true-scale replicas of the monument, Computer Vision, Projection and other AI-based techniques to enable AR-based interaction for a virtual walkthrough of the monument using laser pointers, gestures, game controllers and voice commands.



The 1st IHSE 2020 Event organised by DST, KSCST and IIT Delhi held on 15th and 16th January, 2020 at the National Museum, Janpath, New Delhi, was coordinated and organized by Team Vizara. It was inaugurated by the Union Minister for Culture and Tourism, GoI and attended by eminent International and Indian experts in the field of Digital Heritage. DST project outcomes under IHDS scheme were showcased including the ViRaasat kiosks of this project in a 1.5 month long Exhibition at the Special Exhibition Hall of the National Museum, New Delhi from January 15th to February 28th 2020. The Exhibition garnered a lot of appreciation from IHSE participants and visitors alike, including DG, UNESCO, and Union Minister of Science and Technology, GoI. (Refer event website www.ihse-event.org/2020/)

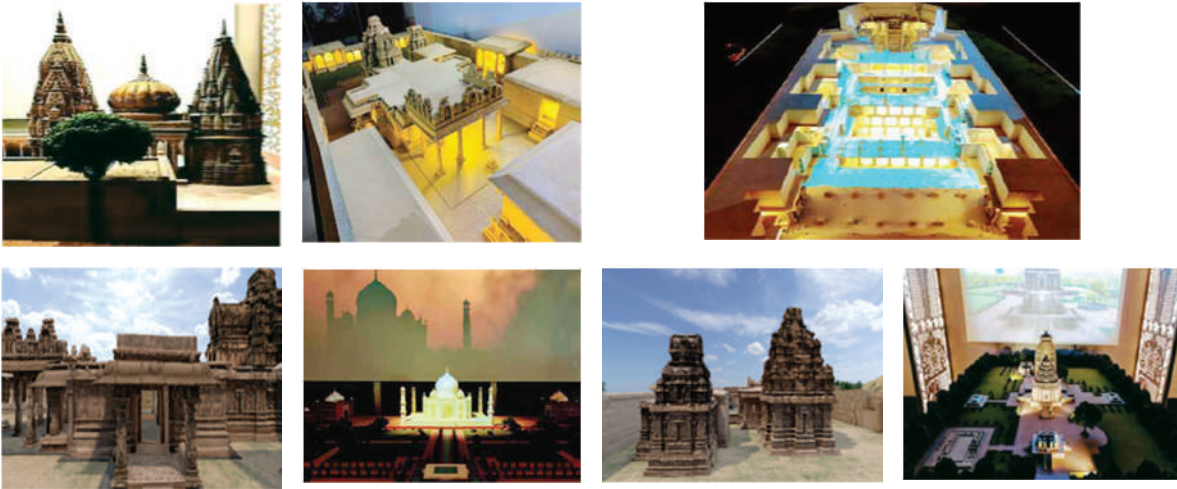

IHDS PROJECT-2 : HAMPI MINI-SPECTACLE PROJECT

TITLE: A Digital Mini-Spectacle for Showcasing the Glory of Hampi



As part of IDH, digital conjectural reconstruction was done mainly of one temple complex of Hampi, that is the Vittala Temple complex. To enhance the Hampi experience and to showcase the glory of Hampi to the world, it was planned that this project will conduct research into digital reconstruction of social life and architecture of some more prominent Hampi monuments, and provide as a deliverable a **Digital Mini-spectacle** of the envisioned grand spectacle of Hampi. The IDH proven technologies to be used in the project were Laser scanning of the monuments, 3D modeling and rendering and developing Interfaces with AR applications, holographic projection and 3D fabrication.

The IDH teams led by IIT Delhi, working in this project were from IIT Bombay, NID Bengaluru, KSCST Bengaluru, CSIR-CBRI Roorkee. Tech startup Vizara technologies, working at the confluence of AR, VR, AI and 3D printing, was the implementing agency working under the aegis of IIT Delhi to implement the deliverables of the project: **A large size replica of the Vijaya Vittala Temple complex** with interesting AR based interactions; **An on-site AR game app** at the site of Virupaksha Bazaar street. An interesting narrative of the Rathotsava festival of Hampi, was finalized as the theme of the app; **Digital reconstructions** for two key monuments of the Hampi Royal Enclosure; Augmented Vittala Temple Musical Pillars.

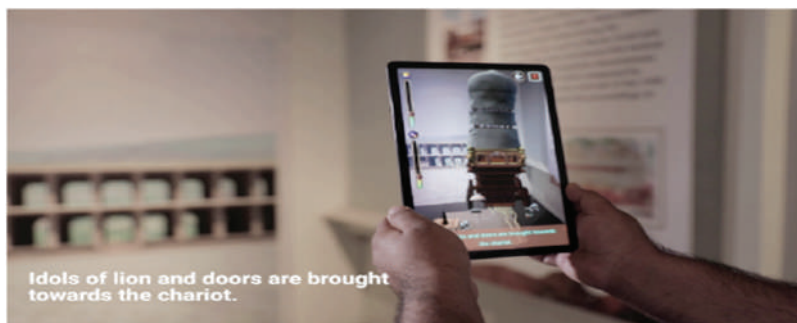
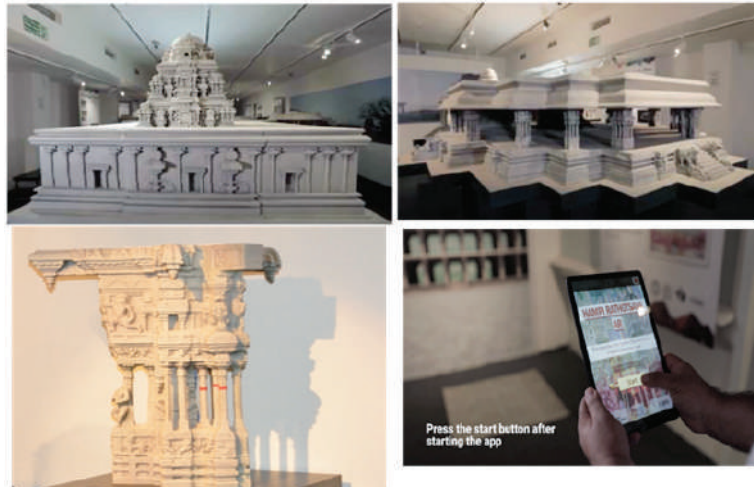

DST PROJECT-3: Gandhi Dome Project

Title : DIGITAL AUGMENTATION OF GANDHI DARSHAN

As part of celebrating Mahatma Gandhi's 150th birth anniversary, and as mandated by our honorable Prime Minister, who advocates the use of Science and Technology and latest techniques such as AR, VR and 360-degree digital experiences, DST took up the task of digitally preserving and presenting Mahatma Gandhi's life and teachings through a 360 Immersive Experience inside an 8-meter Dome Theatre installed at Gandhi Darshan at Raj Ghat. The Dome theatre was installed for showcasing movies focusing on the life and times of Mahatma Gandhi. These movies provide an immersive audio-visual experience to the viewers and the use of this immersive technology is very attractive and engaging for the younger generation who needs to be excited to learn about these values which are relevant forever.

The 8 meter Dome Theatre set up at the Gandhi Darshan is an outdoor dome theatre which consists of a large hemi-spherical projection surface with multiple calibrated projectors. It creates a sense of immersion into a virtual or real remote environment and can be viewed by many people simultaneously. Four films based on Gandhi ji's life and teachings that have been created to play in it are : 1. Mohan to Mahatma - South African Sojourn; 2. Freedom from Fear; 3. Gandhi Forever; 4. The Last Phase.

The films focus on the thoughts and philosophy underlying Mahatma Gandhi's every action. Making them engaging for the young viewers through use of graphics, re-enactments and actual visuals filmed during that time. This theatre is a unique, immersive experience for the viewers that will make the Mahatma come alive on screen and renew the Mahatma's message of peace, non-violence, self-reliance and non-possession.



MOHAN TO MAHATMA : THE SOUTH AFRICA YEARS

This film traces the formative years of Gandhi's life. It cover his South Africa years where he first experimented with civil disobedience. Through a series of mass movements, he would emerge as a leader of the people.



FREEDOM FROM FEAR
In this film, Gandhi's key campaigns in India's struggle for freedom are covered. The concept of Satyagraha is explained, and the film recreates the Champaran satyagraha and the Dandi march.



THE LAST PHASE
Here, the events leading up to Gandhi's assassination are covered. We see the miracle of Calcutta brought about by Gandhi. And the last part of his life, trying to stop the rioting in Delhi. The film ends with his death.



GANDHI FOREVER
The last film of the series explores the relevance of Gandhi and his teachings for today's youth. It covers Gandhi's work to bring about social justice; ending untouchability; a green lifestyle; and particularly relevant in the present time, his work in trying to achieve communal harmony.

The Dome Theatre was jointly inaugurated on the 6th of November 2020 by the honorable Minister of Science and Technology, Dr. Harsh Vardhan and Minister of Culture and Tourism, Shri Prahlad Singh Patel.



One of the focused area of research is Under water studies of submerged cities like Dwarka and Poompuhar and nearly 30 Cluster proposals have been initiated so far. The study involves under water surveys by remotely operated vehicles and photography, sea bed drilling, remote sensing based geo dynamics studies to bring out a comprehensive information on the time

series evolution and extinction. The study also involves the visualisation of geo dynamic processes of the last 20,000 years like land subsidence, sea level rise, Cauvery's migration, floods, tsunami, cyclones and erosion. Finally, the life history of Poempuhar will be digitally re-constructed. The study is also expected to provide packages of scientific information not only on the life history of Poempuhar and the socio- cultural evolution but also the science and technological evolution and the disaster history of this region. However, despite several studies by the various scholars, archaeologists, historians, Epigraphists, Underwater exploration scientists and Geoscientists, there remained several mysteries around Dwarika and Poempuhar as regards to its place of initial establishment, time series evolution and reasons and period/s of its extinction; so to say the holistic life history of such a leading port cities of maritime importance

Final deliverables of scientific and societal benefits

The Project "*Digital Reconstruction of Poempuhar*" on completion is expected to bring out scintillating set of new information that

- Digitally reconstructed model on the life history of Poempuhar
- Animation model on the origin, evolution and extinction of Poempuhar
- Virtual walk through model in the submerged Poempuhar
- Socio- cultural evolution of this part of the country at least from 20,000 years onwards
- Land–ocean interactive changes and their impact over coastal systems and the dwellings
- Possibilities for the predictive models on the future natural disasters / vulnerability (land subsidence, sea level changes, floods of the low lying coasts, storm surges, tsunamis, cyclones, coastal erosion and sedimentation) from the visualisations made from 20,000 years to study their input over the extinction of Poempuhar.
- New methods for underwater data acquisition and new algorithms for data processing.
- Methodology and protocol for the study of Sunken cities and the ports in India and around the world

INNOVATION TECHNOLOGY DEVELOPMENT AND DEPLOYMENT

3.1 Technology Development Programmes (TDP)

The Technology Development Programmes (TDP) aims to convert proof-of-concepts for technologies/ techniques/ processes/products into advance prototypes for validation and demonstration in field settings. The main objectives of the program include:

- Support R&D for development of innovative technologies in identified areas.
- Promote application of advanced technology for improving the performance and value addition to existing technology.
- Capacity building in the area of technology development in terms of human resource and infra-structure.

All the components under TDP are aligned to National priorities and ongoing National programmes. The sub schemes of TDP are:

- Advanced Manufacturing Technologies (AMT)
- Biomedical Device and Technology Development Program (BDTD)
- Device Development Program (DDP)
- Science and Heritage Research Initiative (SHRI)
- Technology Development Program (TDP)
- Technology Mission for Indian Railways (TMIR)
- Waste Management Technologies (WMT)
- Technology Enabling Centres (TEC) for Universities

Science and Heritage Research Initiative (SHRI): A Centre of Excellence was established at CBRI, Roorkee to study the architecture and material analysis and at Rakhigarhi to work on the scientific evidences for the ancient civilization of historic town of Rakhigarhi, Hissar, Haryana.

Waste Management Technologies (WMT): A call for proposals was launched after

consultation with line ministries, industries and institutions on eleven identified areas and on closure, 620 proposals were received. A framework for “Concerted action plan to handle and utilize the waste in India” was developed and a Note for Committee of Secretaries (CoS) was prepared. A meeting of CoS was convened on 5th January, 2021. The action plan is being finalized with inputs from 23 Ministries.

Device Development Program (DDP): A call for proposals was launched with focus on Food Processing/adulteration detection, Environmental monitoring devices/ Early warning Systems, sensor based devices for disaster risk reduction and management (related to Natural, Climate, Agriculture, Chemical, biological etc. and Drone/ Anti drone related devices. On closure, 730 proposals were received and 136 were shortlisted after first level screening.

Biomedical Device and Technology Development Program (BDTD): A call for proposals was launched with focus on women health, mental health, infectious diseases (viral and bacterial) and Grand Challenge on “Nutritional Status” assessment. On closure, 236 proposals were received and 84 were shortlisted after first level screening.

Technology Mission on Indian Railways (TMIR) is a consortium of Ministry of Railways, Ministry of Human Resource Development, Ministry of Science and Technology and Ministry of Industries on an investment sharing model for taking up identified railway projects for applied research and use on Indian Railways. Under DST supported project, sustained joint efforts of researchers and engineers at IIT Kanpur and MCF Raebareli have led to this indigenous Industry 4.0 protocol comprising sensorisation, data acquisition, signal processing and machine learning, running through the entire design-production chain. It would now be possible to monitor the manufacturing process in Real Time, enabling optimisation, planning, scheduling and decision making in a dynamic manner to multiplicatively enhance the production and quality. The architecture conceptualized and formulated at MCF holds promise to gradual expansion of Industry 4.0 in other manufacturing spheres.

Technology Enabling Centres (TEC) have been established in the Universities to bridge the gap between technology development and incubation activity and enable the investigators to pursue applied research involving stakeholders like industry, society and local government. 9 TECs and 2 satellite centres are actively pursuing various activities such as:

- Conducting Entrepreneur training program at a state level
- Lectures on IPR from University Staff as well as from Patents office representatives, assisting in filing patents
- Interacting with industry experts for possible technology co-operation
- Assisting in product validation, IP filing, Tech transfer
- Sensitization & training programs on design thinking

- Visiting MSME to understand their problems
- Training workshops on social media advertising
- Bringing out publications and compilations of developed technologies

Hubs for Development of Biomedical Devices

National Hub for Healthcare instrumentation Development (NHHID), Anna University has been focusing on “Medical Device Development & Commercialization”. The major achievements include:

- AU Sanitizer (developed in NHHID) to Jet Inks Pvt Ltd & in final stages of signing with 2 more companies (Hindcon Chemicals & Swiss Garnier).
- Anitibiogram Device (developed in UPE transferred through NHHID) to Microbiological Laboratory Research Sciences.
- Prototypes developed in NHHID Phase II, like Web based Audiometer, Urinometer and Transosseous Repair are ready for Commercialization



Fig . MoA Agreement Signing between AU & Jet Inks



Automated Antibigram Device

Biomedical Instruments and Devices (BID) Hub at Postgraduate Institute of Medical Education and Research (PGIMER), Chandigarh

- Calibration Testing Centre at BID-HUB: The analyzers setup at the BID-Hub calibration testing centre are currently used to analyze various biomedical devices for their electrical safety and functional testing viz. flow rate, flow occlusion testing of the syringe/infusion pumps meant for use at various emergency rooms, ICU, CCU, operation theatres, IPD remains a critical factor in quality healthcare delivery.
- SPO2 Analysers Testing (COVID-19 pandemic): At BID-HUB, various SPO2 monitors currently being used for management of COVID-19 patients at PGIMER are being tested, thereby adding a critical parameter towards patient safety and management in the current pandemic.

- **Prototypes/Systems/Products**

AIMS: Remote Monitoring of Patients: Anaesthesia Information Management System (AIMS) – Remote Critical Parameters Monitoring. AIMS is an integrated data acquisition and monitoring platform that enables the capture of several critical patient-related parameters such as Heart Rate, Blood Pressure, Drug infusion rates etc. in an automated and continuous fashion. Therefore, it provides a unique way for effective monitoring of the patient's health in a remote manner minimizing the physical contact.

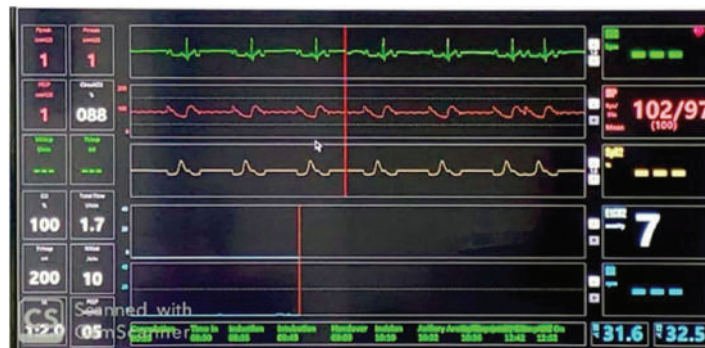

Fig. Remote Monitoring of Patients

ABCD: Artificial Breathing Capability Device: Most hospitals in low-income and middle-income countries are unable to meet the twin requirements of providing ventilators and ICU facilities. To address the dire need, PGIMER Chandigarh's Professor Dr Joseph L Mathew developed the Artificial Breathing Capability Device (ABCD) to automate compression of self-inflating bags (SIB). The critical features

that make this device different from a mere compression of SIB Bag are, controlling peak inspiratory pressure (PIP), ventilation rate (VR) and inspiration to expiration time (I:E) ratio, similar to what is done by a ventilator.

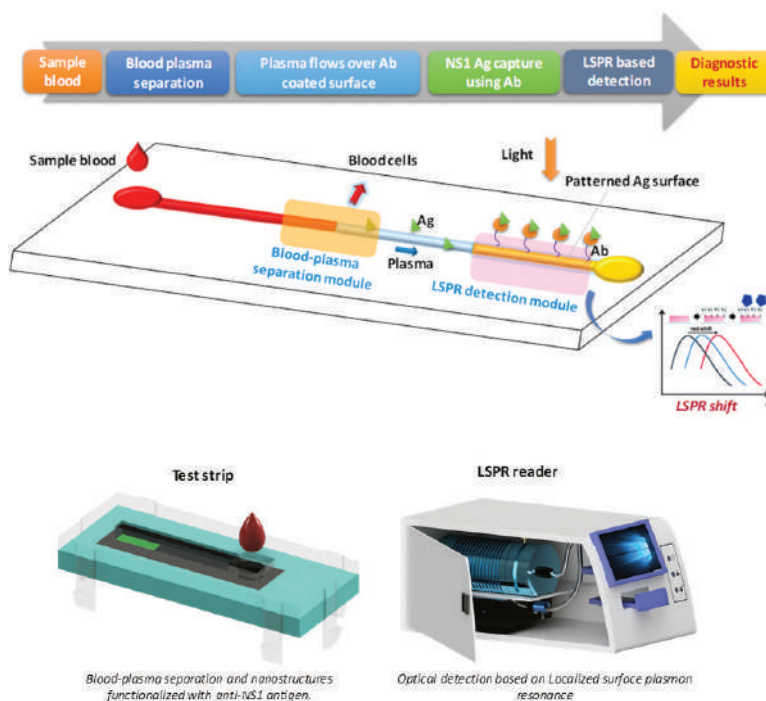

Fig. Artificial Breathing Capability Device (ABCD)

Around 1500 project proposals were received during 2020-21 under various sub schemes of Technology Development Program and are being assessed for funding support. 44 new projects were sanctioned after systematic evaluation by Expert Advisory Committees. 30 projects were successfully completed and some leading demonstrable technologies are as follows:

- **Lab on chip for Blood Plasma Separation and Detection of Antigens using SPR** by Dept. of Mechanical Engineering, Indian Institute of Technology, Madras. The device has two modules- a test strip and an optical reader. The test strip comprises a sample

port, blood-plasma separator and silver-nanostructures functionalized with anti-NS1 antigen. The LSPR reader comprises an excitation source (light) and a optical detector (spectrophotometer). Validated against the well-established ELISA test.



- Continuous Flow Manufacturing of Functional Nanoscale Materials by Chem. Eng. & Proc. Dev. Div., CSIR-National Chemical Laboratory, Pune.** This is a demonstration of continuous flow synthesis of Silver Nanowires of the aspect ratio above 1000 and possessing excellent conductivity. The product from this process is tested in conductive inks and other applications. In flexible electronics. The material chosen in this project were for import substitution as well as for making the Indian chemical industry to enter in the niche area of electronic chemicals. Technology Transfer Agreement in progress with Nanorbital Adv. Materials (Ahmedabad). Material has been supplied to few industries (Deepak Novochem Ltd., Nanorbital Adv. Materials, Clearsynth Labs. Ltd., and BHEL)



Fig. A continuous process for silver nanowires: (Left) Pilot plant inaugurated on Jan 31, 2020; (Middle) Ag NW suspension collected at the reactor outlet and (Right) FE-SEM image of silver nanowires synthesized in the pilot plant.

- Process development of Potato Peel bio-refinery by Department of Chemical Engineering, Visvesvaraya National Institute of Technology, Nagpur (Maharashtra). The novelty of the process is to use waste potatoes in bio refinery way to make values products with ZERO discharge. Waste of potato processing using is separated into peel and starch rich effluent. The effluent is used for biogas production using anaerobic digester while the peels are used to extract poly phenols and dietary fibres. The pilot plant of 100 kg capacity is installed at Merino Industries, Hapur. Upon optimisation of operational parameters same will be scaled up to commercial level.

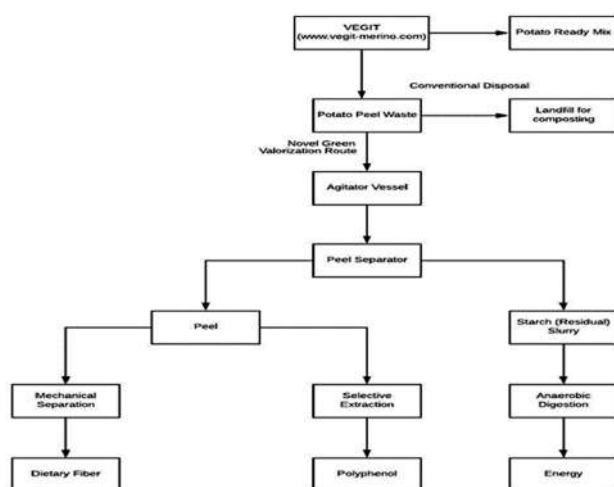

Fig Schematic of waste potato peel bio refinery



- Intelligent Stethoscope: A low cost device based on body auscultation for early medical diagnosis of heart, lung and prenatal health by Centre for Advanced Studies, Dr. A.P.J. Abdul Kalam Technical University, Lucknow, Uttar Pradesh and Fortis Hospital, Delhi.** It is a low-cost, real time, small portable intelligent device based on artificial intelligence where machine learning and deep learning is used for training the model for heart, lungs and prenatal sound. It can be used for the screening purpose in the remote locations, primary health care centres, health care camps, medical clinics and personal use.

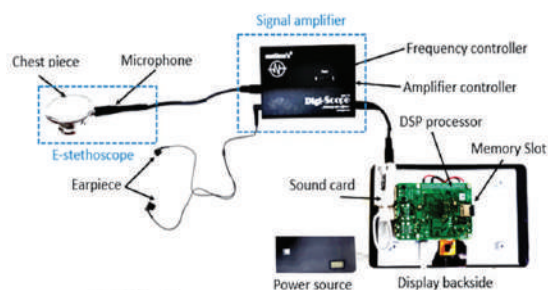
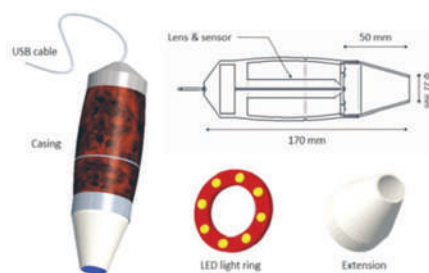
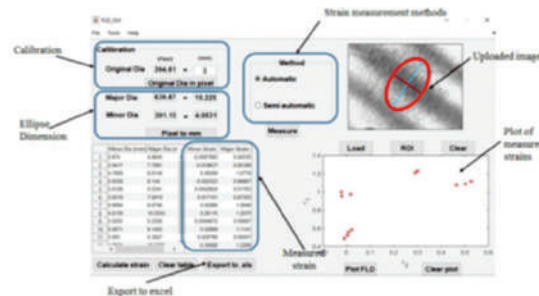

Fig. Developed prototype presenting its components: a low-cost DSP processor with a touch-screen, rechargeable battery, sound card and a stethoscope.

- Development of Image processing Based Portable Device to Measure the Surface Strains in Sheet Metal Forming by BITS Pilani, Hyderabad Campus.** Strain analysis is an essential step in sheet forming applications to understand the deformation behaviour of the material. An image processing based low cost software has been developed with user-friendly (Graphical User Interface) GUI for strain measurement and analysis in sheet metal forming operations. The software has been tested on images obtained by printing the ellipses of known dimensions on the flat sheet by laser etching, electrochemical etching, and screen printing, which are generally used for printing circular grids on flat sheets for strain analysis in sheet metal forming. It is observed that the edges of the laser-etched ellipse are very slim and easily detected by software compared to other grid printing methods. The developed software can measure the strains with an error percentage of 1.975 % .



Hardware for image acquisition



Strain measurement module of CGA software

- Development of smart medium voltage circuit breaker with embedded control device and magnetic actuating mechanism consisting of self-monitoring, low-energy consumption, IoT enabled features for railways and substations applications by Sona College of Technology, Salem, Tamil nadu.** Medium voltage circuit breakers are one of the most important components in electric power system. SF₆ gas filled porcelain housing was replaced with light weight, high dielectric strength polymeric nanocomposite material which will reduce 90% of the weight of conventional porcelain insulator and in turn it will also reduce the size and space required for circuit breaker assembly. In addition, conventional spring loaded operating mechanism of circuit breaker is replaced with magnetic actuated operating mechanism which will reduce the number of moving parts to 45% with enhanced reliability.

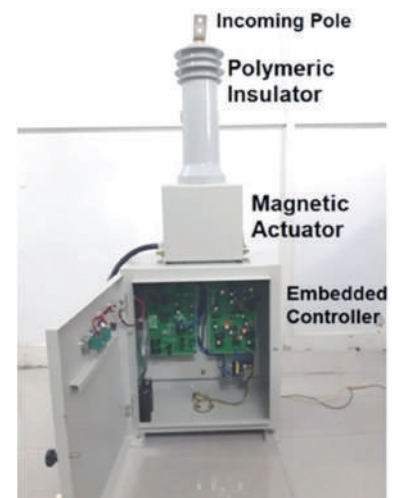

Smart medium voltage circuit breaker

- Design and Development of Sensor Based Sewage Block Remover and Management System by K.L.N. College of Engineering, Tamil Nadu . The System provides a complete turnkey solution for solid, rigid, semi-permeable blocks between the Man-holes and sanitary pipe lines of diameter ranges from 4 inches to 30 inches. Further our system is capable of providing alarms to identify the possibility of overflow in a Man-hole using its unique identification number. The operator at the operators console acknowledges it and take necessary action through a layman using a mechanical remover system that will agitate the choke and thereby to remove the blocks and the slurries are sucked through a pumping unit. The system is user friendly, takes less time consumption to identify and remove the block, easy maintenance at an affordable price by the end users.



Fig. Portable Sewage Block Remover system and Control Panel

- Development of Low-cost Raman Spectrometer by Jawaharlal Nehru Centre for Advanced Scientific Research, Bangalore. The developed miniature Raman spectrometer uses a compact solid-state laser to provide excitation of the system under study. The miniature spectrometer comprises of the laser, optical components, monochromator, and the motorized XYZ sample stage, that can be easily installed in any location. A combination of optics collects the scattered light from the sample and incidents it onto a CCD chip which then by a software is converted into a readable spectrum.

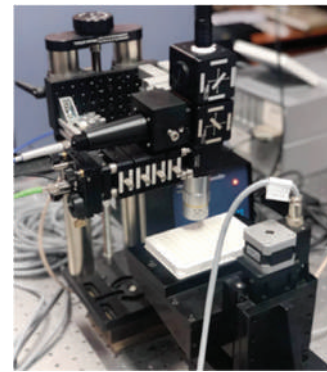

Fig. Prototype of Low-cost Raman Spectrometer

- Development of an Axial flow Turbine test Rig by Indian Institute of Technology Kanpur (IITK). Currently educational institutions across the world that teach Turbomachinery are equipped with demonstrators that use water as the medium. An axial flow turbine test rig, using air as the medium, is not available in the market, in a scale suitable for educational institutions to use as a Teaching aid. To develop a single stage axial flow turbine test rig, operating with air, for demonstration of turbine operation and associated measurements to undergraduate and post graduate students. The design was carried out from the perspective of making it affordable, while offering a unique learning experience.

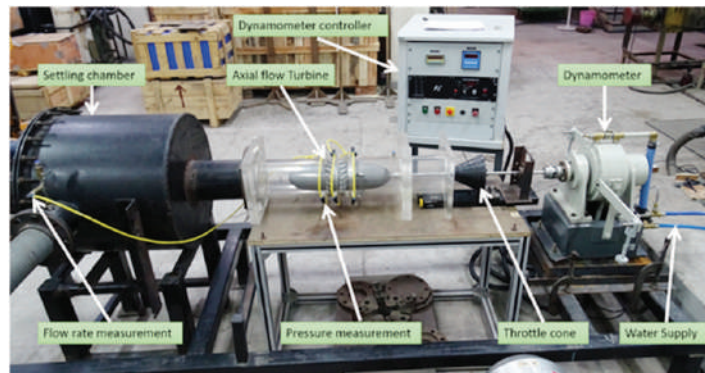

Fig. Overview of the entire system, along with all associated components

- Shape Memory Technology for Smart Textiles by Indian Institute of Technology, Delhi. Prototype of shape memory products for textile and clothing, optimized of memory polymer with actuation capacity in between 30-50 °C, process optimization of filaments by spinning with good thermal and mechanical properties and designing engineered fabric structure with excellent shape memory performance. Such textiles have wide applications in segments like Crease recovery, Compression bandage, Healthcare, Sports & fitness, and Fashion Industry.

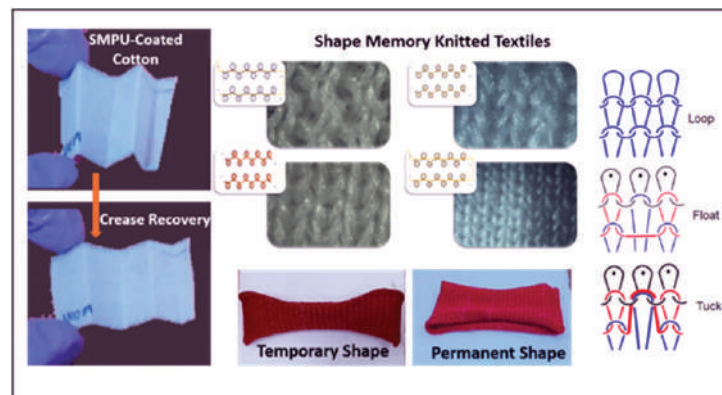

Fig. Shape Memory Textiles

- **Development of smart socks for wireless monitoring of human gait by PSG Institute of Advanced Studies, Coimbatore, Tamil nadu.** The device is developed for the human gait testing for understanding human walking condition normal and abnormal. Double layered cotton smart socks with the conducting thread knitted were designed. The piezoelectric sensors were stitched in the socks for human trials. Conducting threads are knitted in the socks to accommodate three sensors at heel and toe positions. The sensors are connected to ESP32 microcontroller ADC port through conducting thread. Human Gait patterns are generated by wearing the socks and walk for 5 to 10 minutes.



Fig. Microcontroller with Sensor embedded socks

- Rotary drum composting (RDC) and anaerobic biphased baffled reactor (ABBR) technology for bimethanation of industrial sludges and aquatic weeds by Indian Institute of Technology, Guwahati, Assam. Rotary drum composters are in-vessel systems with engineered designs that are completely different from other conventional methods practiced earlier. A unique feature of the system is that large volume of waste material can be decomposed within an enclosed space in a continuous mode within shorter time under controlled process. Therefore, drum composting of aquatic wastes is an efficient and promising technique with its decentralized processing of the material as it provides uniform agitation, aeration and mixing of the compost material to produce a stabilized high quality end product. ABBR has been installed at Maubuang village, Mizoram by the PHED, through the Govardhan scheme.
- Development of Fluorine Doped Graphene Based Titania Photocatalytic Membranes for Water treatment applications by A.C.Tech, Anna University, Chennai. Hybrid photocatalytic membranes technology for the detoxification of different organic pollutants is being targeted. This project is intended for detoxifying several organic pollutants present in the different industrial effluents. Coupling membrane filtration with photocatalysis renders an alternative route to mitigate the several associated problems in membrane filtration process. During this process, photogenerated reactive oxygen species can efficiently degrade various organic pollutants into carbon dioxide and water. The chemical, pharmaceutical, agro, textile and leather industries can also adopt this technology for their effluent treatment.



Fig. Image of the continuous rotary drum composter(RDC) installed at IIT Guwahati



Fig. Fabricated Photocatalytic Membrane Reactor

3.2 Technology Mission Division (CERI & WTI)

3.2.1 Clean Energy Research Initiative (CERI)

The overarching objective of CERI is to nurture S&T led breakthroughs to make clean energy affordable and accessible through strengthening Research and Innovation Eco-System for Clean Energy. CERI aims to:

- Support upstream end of research to generate advanced knowledge of potential application to clean energy
- Accelerate India centric innovations developed around user needs
- Promote national, bilateral and multilateral collaboration between industry, academics, utilities and other stakeholders to gain value for such connections
- Create national research competence in Clean Energy through human and institutional capacity development.

During the year 2020-21, several new dimensions were added to the programme to accelerate the pace of clean innovations to meet national needs, which are as under:

Mission Innovation: Mission Innovation (MI) is a global initiative of 25 countries to dramatically accelerate global clean energy innovation. Participating nations have committed to double their governments' clean energy research and development (R&D) investments over five years, while encouraging greater levels of private sector investment in transformative clean energy technologies.

Mission Innovation Challenge #1: Smart Grids: India is one of the Co-led in Smart Grids Innovation Challenge. The Challenge targets innovation and deployment of reliable, efficient and affordable smart grids technologies at regional, distribution and micro-grids levels in various geographical areas to achieve the ability to accommodate 100% renewable based energy sources in power grids. In addition, IC1 also focuses on the aspects related to cross innovation.

- Developed a Smart Grids Innovation Accelerator (SGIA) platform, which is a cloud-based platform to effectively share knowledge on Smart Grids. SGIA platform will serve as a suitable tool to enable sharing of policies, strategies, scenarios, position or white papers, technical reports, use cases, case studies, best practices, roadmaps, implementation plans and digital twin objects catalyzing the public and private sectors joint efforts towards IC1 goals to accelerate the development and deployment of innovative smart grids technologies worldwide. The SGIA platform will cover not only technological but also policy & regulatory and financial aspects, involving all relevant stakeholders. The SGIA platform will be supported by artificial intelligence algorithms that would translate the documents from different languages and will also make possible for the user to search and read the results in a few different languages.

- The UK-India Joint Virtual Clean Energy Centre (JVCEC) Conference was held on 21-22 September 2020 through online. Attendees included some 50 Indian academics from Kharagpur, Bombay, Kanpur, Delhi, Hyderabad, Bangalore, Jaipur, Bhubaneswar, Shibpur, Madras, Thiruvananthapuram and Tezpur, and 50 UK academics and researchers from Loughborough, Imperial, Exeter, Southampton, Manchester, Birmingham, and Warwick. The conference brought together the leading academics in the Clean Energy field from the UK and India and enabled valuable discussions on key challenges and collaborative work in the integration of solar PV, energy storage and electrical networks. Presentations of ongoing collaborations between UK and Indian academics within the three centres, JUICE, IUCERCE and UKICERI, helped strengthen the existing links and identify emerging possibilities for collaboration between the two countries in Clean Energy.
- A joint meeting cum workshop was held on July 21-24, 2020 through online, wherein Indian and US academic institutions and Industry has been participated and presented the work done on US-India collaborative for smart distribution System with Storage under the Indo-US Joint Clean Energy Research and Development Centre (JCERDC) programme.

Mission Innovation Challenge # 3: Carbon Capture and Utilization: This challenge aims to enable near-zero CO₂ emissions from power plants and carbon intensive industries. DST has supported 19 multilateral projects in collaboration with MI partner country investing an overall amount of Rs. 18.5 crores.

- Jawaharlal Nehru Center for Advanced Scientific Research, Bengaluru team is working on development of integrated technologies for CO₂ reduction to value added products. The team is Hybrid thermocatalytic CO₂ reduction technology with carbon capture unit and hydrogen generation unit.
- National Geophysical Research Institute (NGRI) project team is working on conducting a systematic large-scale assessment for potential of CO₂ enhanced oil and natural gas recovery in key sedimentary basins in India. In this intervention, a workflow for calculating estimates of CO₂ storage capacities through CO₂-EOR has been developed based on a review of best practices used worldwide and previous case studies.

Mission Innovation Challenge # 5: Converting Sunlight: This challenge aims to develop novel and innovative affordable ways to convert sunlight into storable solar fuels. DST had funded 8 trans-national collaborative projects on 'Conversion of Sunlight to Storable fuels.

- IIT-Madras research team is developing two dimensional catalysts based on Metal organic Frameworks (MOF) and working on design and development of large area (100 cm²) carbon dioxide electrolyzer for conversion of carbon dioxide to fuels. The device consists of a silver coated carbon paper as a cathode for CO₂ reduction, cobalt phosphate (CoPi) coated nickel foam as an anode for water oxidation, separated by a

proton conducting Nafion membrane. The entire device is sandwiched by electrolyzer flow field metal setup for the flow of carbon dioxide and water. The details are shown in Figures given below

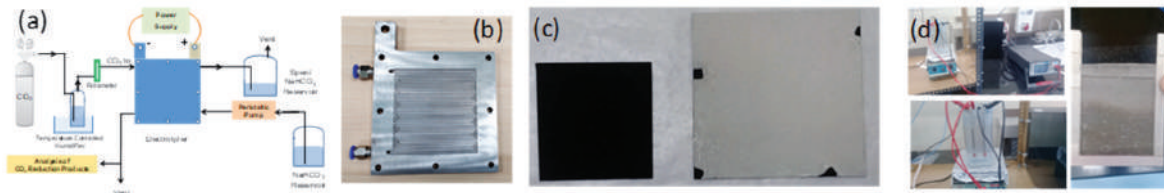

Fig. (a) Design of electrolyzer, (b) electrolyzer flow field on a stainless steel plate, (c) thermally evaporated silver on a carbon paper, and (d) electrodeposition of CoPi on a Ni-foam

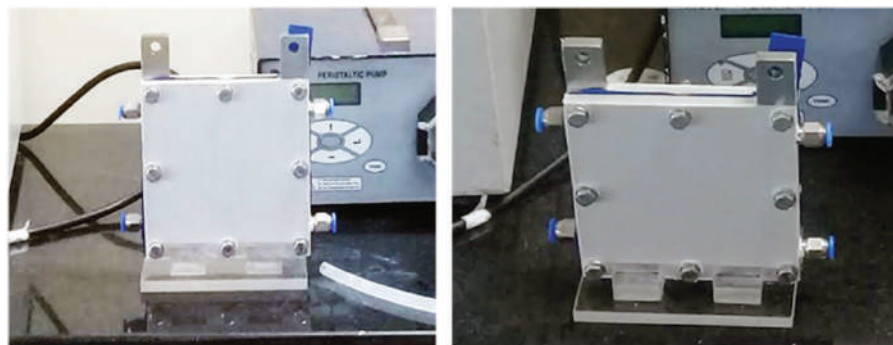

Fig. Completed large area electrolyzer setup (100 cm² active area)

Mission Innovation Challenge #7: Affordable Heating and Cooling of Buildings: The objective of this challenge is to make low-carbon heating and cooling affordable for everyone. Under IC 7 six thrust areas have been identified in consultation with MI member countries for Research, Development and Demonstration (RDD). DST is leading one of the thrust area viz. Thermal Comfort and actively participating in other five thrust areas.

- Published an international status report on thermal comfort research and its application in achieving low energy heating and cooling. The report presents a comprehensive summary of research findings around the globe and way forward in the thermal comfort priority area.
- DST is taking an active role in furthering thermal comfort research and it's dovetailing with building energy efficiency. In this context, DST's ongoing initiatives include delineation of thermal comfort requirements in built environments to regulate the operating set points of heating and cooling systems. A research program on comfort driven HVAC system control is being conceived by DST.
- DST is currently administering an international survey with MI member countries on thermal comfort research and development. The survey administered to leading researchers and funding agencies intends to capture research directions in thermal comfort, challenges being addressed and future prospects.

- DST is working with IEIA on comfort climate box for tropical regions. This intends to develop a sustainable, modular and comfortable living environment for tropical regions

Smart Grids

- Indian and European leaders has partnered in the Clean Energy and Climate, this Partnership foresees strengthened cooperation in energy research and innovation, mainly in renewable energy and its integration in the energy system. Prof. Ashutosh Sharma, Secretary, DST along with European Union Ambassador to India Mr. Ugo Astuto has announced India-European Union Flagship Call on Integrated Local Energy Systems at India Smart Utility Week 2020 on 4th March, 2020 . This India-EU Flagship call will develop and demonstrate novel solutions, integrating all energy vectors (electricity, heating, cooling, water, wastes, etc.), including possibilities offered by batteries and electric vehicles, interconnect them and optimize joint operation with increased share of renewables and a higher energy efficiency.



Fig. Announcement of India-EU Flagship call on Integrated Local Energy Systems

- Development of a smart electric vehicle charger with remote power control, integrated solar photo voltaic to support grid during peak hours, which can be interchangeability used for 2, 3 and 4 wheelers and generates bills with smart metering. It also caters to higher driving range, where, high energy density batteries are required. These are not available in conventional EV chargers. It

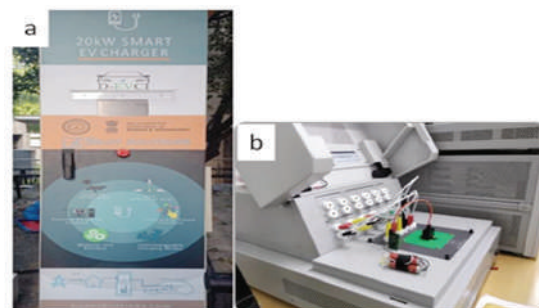

Fig. a) Developed 20kW smart charger b) GaN based E-mode platform technology

It is also integrated with solar photo voltaic to support grid during peak hours and a real power support within its capability to the grid is provided for enhancing voltage and frequency regulation. Bidirectional communication with the grid has been incorporated helping it score over current chargers and ensuring grid support. Vehicle to grid (V2G), and vehicle to grid reactive power (V2GQ) capabilities are also included.

- Development of AlGaIn/GaN Power Transistor Based Platform to support the self-sufficiency of India in the area of power electronic transistors and converters. AlGaIn/GaN Power HEMTs are slated to replace Silicon Power MOSFETs for applications up to 600V. These would include sub-systems such as battery management systems and variable speed drives, for system level applications like smart grid, renewable energy, electric vehicles, avionics, space vehicles, and weapon systems.
- Development of a solar-agriculture farm to enable multiple land use, viz., for agriculture as well as for solar energy farming. This will provide a stable and a second source of income for the farmer, even if he loses the crop due to vagaries of weather. The concept of solar-agriculture farm can be utilized to install the plants at the outskirts of the city without hampering agriculture, thereby saving lot of money and effort. The demonstration setup hosts a set of 19 sun-tracking towers, each accommodating 32 transparent solar modules of 345Wp, at a height of 18'.

Research & Development on Clean Coal Technologies

Advanced Ultra Super Critical (AUSC) Thermal Power Plant –R&D Phase: The mission programme progressed as per schedule. Two DST projects also made good progress. Highlight of the work are listed below:

High Temperature Spin Test Rig (HTSTR) facility will enable design validation of 800 Megawatts AUSC steam Turbine rotors for certifying the long term performance of Super alloy Monometallic and Bimetallic welded rotor with a total of 2000 startups (Hot+warm+cold) and 100000 hours of total steady state operation. This was achieved, through accelerated testing within 200 cycles and 10000 hours respectively. A unique test protocol for accelerated testing was formulated by the BHEL team with the guidelines of ASME standards. Two rotor segments – Monometallic (Alloy 617M) and Bimetallic welded portions (Alloy 617M and 10 Chrome) of actual steam turbine rotor will be subjected to equivalent operating conditions over its guaranteed time line by increasing the temperatures and achieving desired thermal gradients within the rotors, during the heating and cooling operations.

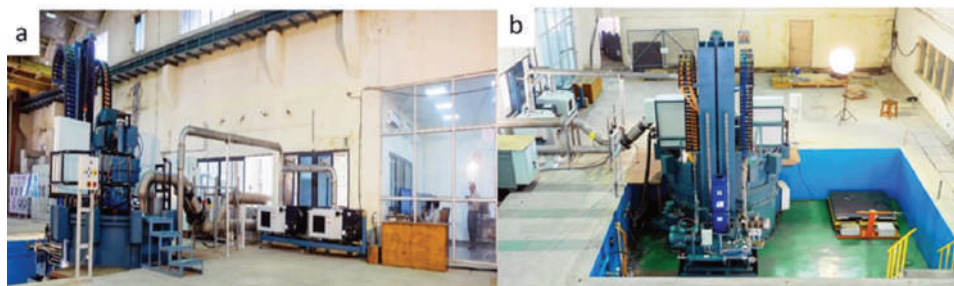

Fig a) Rotor Test Rig, Vacuum Pumps and Control Room b) Rotor Test Rig and Movable Pneumatic Loading Station in

- DST supported two national clean coal centres to address critical R&D challenges towards development of clean coal technologies, in tandem with developing supercritical power

plant technologies, both at the system level as well as development of materials and develop processing and fabrication technologies namely, coating, welding, machining and new materials for High Performance Power Generating Systems (HPPGS) in coal based power plants through a prototype demonstration.

- Development of a microbial process for generation of methane from Coal Bed Methane (CBM) wells with poor to marginal CBM prospects. Understanding the mechanism for the biological generation of methane from coal seam. Core flood studies to verify biotechnological intervention.

Cleaner Fuel: DST supported a major development programme for production of Methanol from various input sources including Indian coal and, CO₂ from thermal plants, steel plants etc. The programme aims to include direct utilization of Methanol and DME as drop-in fuel in automobiles and fuel cell-based vehicles. DST supported two major projects for development of 0.25 TPD (Fig. 6 a) and 1.0 TPD (Fig 6b) of methanol from high ash Indian Coal using Fluidized bed gasification pilot plant at BHEL, Hyderabad and Thermax Pvt. Ltd., Pune respectively.

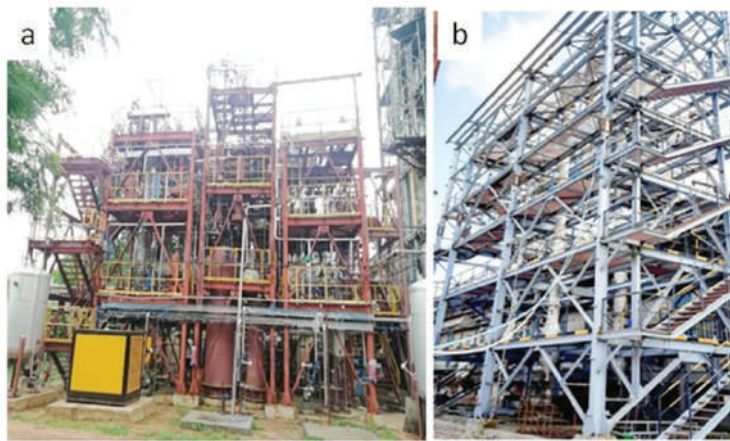

Fig a) 0.25 TPD Coal to methanol Pilot plant at BHEL, Hyderabad. b) 1 TPD Coal to methanol Pilot plant (under construction) at Thermax, Pune

- Modification of an existing automotive diesel engine with a capability to operate in Methanol/Diesel, Methanol/DME Methanol/Biodiesel, and Methanol/PODE under advanced combustion mode called dual fuel reactivity-controlled compression ignition (DFRCCI) combustion. The engine system is completely flexible for dual fuel engine and combustion mode engines. The system is also applicable for off-road engines as well, tested, demonstrated and published. The system achieved on average an 8% improvement in fuel efficiency compared to conventional diesel engine systems and also better NO_x/Soot trade-off which is near to current emission limits (BS VI). A dedicated DME fuel supply system was developed in-house, integrated and tested with the engine.

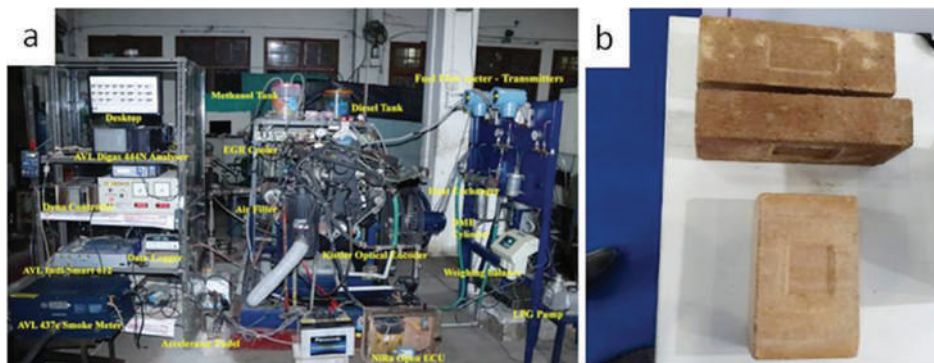

Fig. a) Automotive engine test rig for effective utilisation of Methanol and Dimethyl Ether (DME). b) Alkali-activated low carbon compressed earth bricks

Building Energy Efficiency: Development of Low-C bricks from construction and demolition (C&D) wastes through alkali activation process. The approach is in the utilization of C&D waste as raw material and pozzolanic materials as binders which results in the safe management of waste, reduced pressure on natural resources and lower emissions and embodied energy.



Fig. Dissemination of projects at ACREX-2020.

Dissemination of outcomes of DST supported projects: ACREX India is an International conference-cum-exhibition of Air Conditioning, Health, Ventilation and Intelligent Buildings, held during 27-29 February, 2020. Provided a platform for six national, bi-lateral and multi-lateral projects to showcase their technology in the “ACREX 2020”. All the projects possess promising potential for commercialization and key industry stakeholders and leading market players were highly impressed with the presented technologies and concepts. The event witnessed more than 30000 attendees and participation of about 350 industries. It provided a platform for industry-academia liaisoning as a part of DST’s mission towards sustainable development.

Space Heating System : A solar-powered PCM (Phase Change Material) integrated space heating system has been designed by Pluss Advanced Technologies Private Limited with the support of the DST. The clean energy system designed to provide warmth in high altitude areas where night temperatures may fall to as low as -20°C , is scheduled to be set up in Leh in Ladakh. The developed system has the potential to meet the needs of space heating in residential schools, tourist shelters and for a large number of houses in Ladakh.

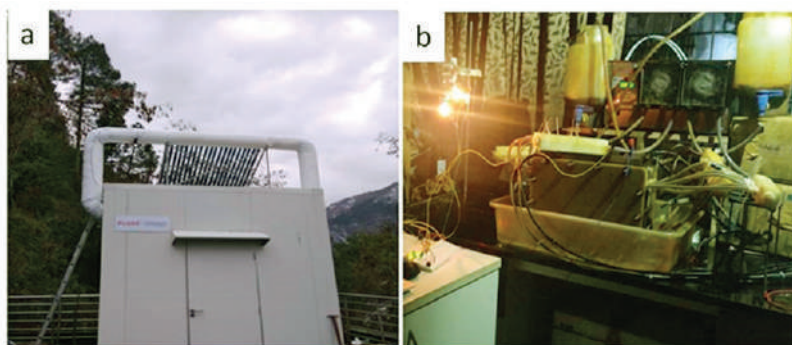

Fig. a) Space Heating Prototype. b) Powering of 500 W bulbs from developed IRFBs.

Materials for Energy Storage

Iron electrolyte based Redox flow Battery (IRFB): Center for Incubation, Innovation, Research and Consultancy” (CIIRC), Bengaluru has pulled off an arduous milestone in the development of Iron electrolyte based Redox flow Battery (IRFB) funded by DST, under its flagship Materials for Energy Storage (MES) Scheme. The team has successfully tested lighting loads using the developed flow battery and found that the battery has the capacity to power houses across rural India thus having a societal and environmental impact besides being a potential competitor for various household and industrial batteries available in the market. The team has a vision of developing and setting up IRFB charging stations for recharging Electric Vehicles batteries in the country, thereby creating a complete “Well to Wheel” green ecosystem. The battery can be promoted as a cost effective and green system considering the materials used for development, electrolyte and the area of applications (Renewable energy sector).

Solar Energy: The following are the major outcomes of the Research and Development work supported under Solar Energy domain:

- **Inauguration of the DST-IEST Solar Hub at IEST Shibpur, West Bengal.** Honourable Union Education Minister Dr. Ramesh Pokhriyal Nishank virtually inaugurated the Solar hub established at IEST, Shibpur on 27 Oct 2020. The Solar hub has been set up to help the local and national-level solar cell and module manufacturing industries to modernise and upgrade their solar energy devices and systems. Direct interactions with this DST-IEST Solar Hub will enable the transfer of indigenous knowhow and training for the fabrication and characterization of different architecture of solar cell. The students and research fellows of higher education institutes of West Bengal and the entire eastern and north-eastern region will get hands-on experience at the solar hub. The training provided will be an impetus to the Skill India Mission of the Government of India and further generate and strengthen knowledge in the field of solar energy and solar photovoltaics so that they can contribute to indigenous development and usage of solar energy. A number of Indian industries like BHEL, Vikram Solar, Sova Solar, Agni Power, Synchrotronics etc have already signed MOU with IEST.



Fig. Virtual inauguration of DST -IEST Solar Hub at IEST Shibpur, West Bengal

Fabrication of large area uniform, pin hole free and highly efficient stable Perovskite solar cells

Perovskite solar cells makes one of the most promising photovoltaic technology being researched throughout the world. In this perspective, Prof. Soumitra Satapathi IIT, Roorkee have developed high efficiency (PCE-20%) triple cation stable perovskite solar cells with stability of 60 days. The charge carrier dynamics was investigated through transient and impedance spectroscopy. A phenomenological picture of high efficiency and key stability enhancement protocols for next generation indigenously developed low-cost perovskite photovoltaics has been illustrated. The perovskite devices have potential for use in IOT devices, medical diagnostics devices, smart LED and indoor lighting.

Development of 320 W, 6 cell stack Vanadium Redox Flow Battery Systems Rechargeable through Solar Energy

Redox flow batteries (RFBs) are electrochemical energy storage systems which is the most promising technology for long duration energy storage (LDES) at the electric grid scale. A 320 W 6-cell stack was developed with solar charging option. In the development work, a high surface area carbon is developed from sugarcane bagasse (AC-SCB) which was coated on the carbon felt to increase the electrode surface area, thereby improving the performance of the VRFB. The development work explored PVDF based cation conducting membranes, the alternative membranes to Nafion, in collaboration with CSMCRI. Various electrode modification strategies were developed to improve the performance of the VRFB. N- and P-co-doped porous carbon (GF-NP-900) were prepared and employed as the electro catalyst for the $\text{VO}_2^+/\text{VO}_2$ + redox reaction. This study resulted a peak power density as high as 650 mW cm^{-2} . To check the scalability, the charge-discharge with the catalyst in 6-cell stack up to 1000 cycles has been carried with the use of the solar panel for charging and discharging by load (lamp). Also, 10-cell stack has also been developed and demonstrated with LED array load. With the scientific leads gained in this project, the group has initiated further working to develop a 1kW/10kWh stack. The technology has been developed under the leadership of Dr. Kothandaraman Ramanujam, at IIT, Madras.

Other initiatives

- DST in collaboration with MI and Joint Programming Platform of ERA-NET Smart Energy System launched a Joint call 2020 entitled ‘Digital transformation for green energy transition (MICALL20)’ on 14.12.2020. DST has committed € 1 million for this call.

3.2.2 Water Technology Initiative:

Water Technology Initiative is a pro-active India – centric ‘solution science’ endeavour aims to strengthen the R&D capacity and capability to develop the research based solutions for existing and emerging water challenges facing the country. It includes development research in laboratories and application research in field. The overarching goal of the scheme is to promote RD&D activities which enable winning of water from sustainable sources, augmentation of water quality for specific applications and recycling and reuse of water. This is a need based demand oriented thematic initiative encompassing the entire technology development chain to successively progress to higher technology readiness levels culminating into sustainable solutions. Several achievements made during the FY 2020-21 are as under:

Deployments and demonstrations of Convergent Solutions for portable water:

Off the grid sensor controlled irrigation using bank filtration technology: A demonstration of the bank filtration (BF) wells with off the grid solar pumping system and sensor controlled irrigation system at lake and river bank sites in south Goa has been initiated and towards its completion. In this project, team has also carried out real time data monitoring of water quality using data logger which records the temperature, water level and electrical conductivity. Results demonstrate that the quality of water obtained from RBF wells can be classified as excellent/good for use as irrigation water



Fig. a) RBF well at Navelim Goa Sal River Site. .b) Forward Osmosis system installed at Narippaiyur Village, Ramanathapuram District, Tamil Nadu. c) Solar hot water system installed at Narippaiyur Village, Ramanathapuram District, Tamil Nadu

Solar thermal seawater Forward Osmosis based desalination project: DST has supported Demand Driven mission mode project being implemented by IIT Madras and KGDS Pvt Ltd as solution providers that focuses on providing customized technological water solution by demonstrating futuristic and versatile solar thermal Forward Osmosis (FO) sea water desalination system in Narippaiyur test bed facility in Tamil Nadu for the benefit of local

villagers. The production capacity of FO system is 20 TPD. In this intervention the complete FO system has been installed. Project team has demonstrated FO system and achieved 20,000 litres per day of fresh water production from sea water. Various operational data have been also recorded. The focus of the current development is on streamlining the operation and optimizing the process. The key features of Forward Osmosis system are high recovery, low thermal energy consumption - 35 to 40 kWhth /m³, low electric power consumption - 1.5 kWh / m³, potential for resource recovery, reduced energy consumption; especially in solutions of high osmotic pressure, less fouling of the membrane because of low pressure operation ease and more effective cleaning of the membrane and longer membrane shelf life along with lower operating costs.

Research in emerging areas:

WICTRE lead by IIT Bombay- DST has supported a Water Innovation Centre Technology Research and Education (WICTRE) lead by IIT Bombay comprising of premier academic institutions from all over India, in this intervention an innovative technology has been developed by NCL Pune which has been patented. This is a new process using hydrodynamic cavitation for enhancing degradation of pollutants titled “Solvent assisted cavitation for wastewater treatment”. This intervention is a new multiphase process in which a



Fig. CSIR-NCL Cavitation Pilot Plant for Wastewater Treatment

suitable solvent phase and aqueous phase containing organic pollutants are mixed in a predefined manner and a third vapor phase is allowed to form in the form of cavities for *in-situ* generation of OH. Radicals react with the pollutants resulting in increased removal of COD and/or ammoniacal nitrogen from wastewater. The process operates at nearly ambient conditions, requires no catalyst and can be combined with other established processes such as advanced oxidation, adsorption for further process improvements or for cost benefits or both.

Urban Flood Model for Bangalore city- DST has supported a Demand Driven mission mode intervention with IISc Bangalore in lead, to work on an integrated Urban Flood Model for Bangalore city which is being developed with a modular approach that includes real-time rainfall and weather monitoring followed by a rainfall forecast system feeding into a comprehensive hydrologic flood model. In order to monitor the flow during flood events, a dense network of 100 Telemetric Rain Gauges (TRGs), 26 Water Level Sensors (WLSs), on prominent storm water drains, and 12 Telemetric Weather Stations (TWSs) across Bangalore (709 km²) has been installed and maintained by Karnataka State National Disaster Monitoring Centre (KSNDMC) in collaboration with Bruhat Bengaluru Mahanagara Palike (BBMP). The sensor network transmits the real-time data at a temporal resolution of 15 minutes and is equipped to alert the relevant authorities, in case of heavy rainfall events or significant

increase in flood levels in the flood vulnerable areas that have been mapped thoroughly. The rainfall forecasts and the sensor data are used to obtain the flood forecasts and real-time flood information. The timely dissemination of the flood information to the relevant authorities is carried out through focussed messaging channels for alerting the disaster response units, with 6 hours of lead time. The citizens are updated about the real-time weather/rainfall/flood through a dedicated mobile application, “Bengaluru Megha Sandesha”, first of its kind in the country, and a dynamic web-portal “Varunamitra” (<http://varunamitra.karnataka.gov.in/>), developed by KSNDDMC.

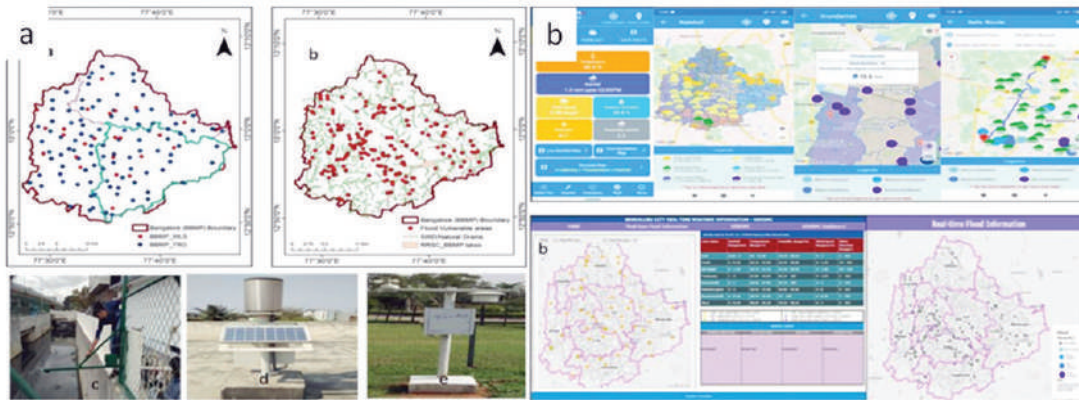

Fig. a) Location of TRGs and WLSs, (b) SWD network (source: BBMP) and flood vulnerable areas (source: KSNDDMC) (c) Installation of WLS (d) Installation of TRGs (e) Installation of TWSS, in Bangalore city. b) Bengaluru Megha Sandesha application interface displaying the near real-time rainfall, flood inundation and the safe route for navigation, (b) Varunamitra web portal interface displaying real-time rainfall and flood information

Bilateral Collaborations

Development of Novel treatment Methods and management of PPCPs in Rivers Wastewater treatment plants and sludge- DST has supported a bilateral Indo UK project in collaboration with NERC/EPSC in which project team has developed appropriate sludge management system for the treatment of bio solids contaminated with Pharmaceuticals and personal care products (PPCPs). Team has also developed continuous flow plasma reactor for the treatment of water and wastewater contaminated with PPCPs. The pilot scale reactor with a capacity of 1000 L/day has been fabricated and the performance evaluation is in progress. In this intervention wet land systems has been constructed for PPCPs removal and team have also identified best substrate materials and plant species to be employed in constructed wetland for the effective removal of PPCPs. Composting system for bio-solids containing PPCPs has also been developed along with Pulsed Power Technology (PPT) for PPCP removal with various reactor configurations

Indo-Dutch collaboration on Urban Water Management- DST has supported one Indo-Dutch consortia titled “Water for Change. Integrative and Fit-for-Purpose Water Sensitive Design Framework for Fast Growing Livable Cities” that was evolved through the extensive Sandpit mechanism in the area of Urban Water Systems against the DST-NWO Call on bilateral

consortia. This consortia is being led by IIT Roorkee as lead along with other consortia member named MANIT, Bhopal; CEPT University, Ahmedabad; IIT Gandhinagar; CWRDM, Calicut.

Mitigation of Air Pollution

Air pollution is a major risk factor for heart disease, stroke, chronic obstructive pulmonary disease (umbrella term for several progressive lung diseases including emphysema) and lung cancer, and increases the risks for acute respiratory infections and exacerbates asthma. Air pollution in India is a serious issue with the major sources being fuelwood and biomass burning, fuel adulteration, vehicle emission and traffic congestion. DST is also making concerted effort in R&D towards mitigation of air pollution.

Development of Portable, Compact, Low powered and Economical, photonic System for Real Time, Remote, In-Situ Monitoring of Air Quality. Provides information on all pollutant gases, particulate matters (PM10, PM2.5, PM1) and meteorological parameters simultaneously with high accuracy and sensitivity. Capacity to monitor simultaneously at spatial ranges from 1m to 1km with high sampling frequency. Calibrated with gold standards, and EffecTech, UK International Standards gases and mixtures, wind tunnel. Inter-compared with imported systems from France (Environment SA) and Australia (EcoTech) in association with ISO Certified Environmental Laboratory of Karnataka State Pollution Control Board (KSPCB), Bangalore, under the aegis of CPCB, India.



Fig. Photonics system for Air Unique Quality Monitoring (AUM).

3.3 National Geospatial Programme (NGP)

Initiated in 1982, the Natural Resources Data Management System (NRDMS), an interdisciplinary research programme has promoted R&D in emerging areas of Geospatial science, technology and providing Geo spatial solutions to area specific problems. Over the years, NRDMS has successfully demonstrated utilities of Geospatial Technologies in decision making and developed capacity for geospatial data and information management at State, District and local levels at pilot scale. Considering the changing requirements of Geospatial Science & Technology in the country, the division has now **evolved into National Geospatial Programme (NGP)** to catalyze the National Geospatial Ecosystem with the mandate of promoting geospatial science and technology, policy, solution, capacity building, entrepreneurship and international cooperation for sustainable socio-economic development at all levels of governance.

3.3.1 *The progress made under various sub-programmes of NGP is as under:*

Geospatial Science Programme

i. National Programme on Geodesy

Geodesy is defined as the discipline that deals with the measurement and representation of the earth, its gravity field and geodynamic phenomena in three-dimensional time varying space. **First and only National Centre for Geodesy (NCG)** has been **established by DST** at Indian Institute of Technology, Kanpur in India (**Figure 1**). It is first of its kind in supporting educational and research activities in the field of Geodesy in India. The center has been established to rejuvenate national-level education on Geodesy and other aligned areas with the primary aim to act as a hub of excellence. It has a vision to support various government agencies in infrastructure development and related areas to facilitate strong industry-academic collaboration in Geodesy. The National Centre for Geodesy has been set up for 5 years with the following objectives:

- Promotion of the state-of-the-art research and development activities (academic research, sponsored/consulting) in Geodesy.
- Capacity building by imparting regular training programmes on Geodesy (long term and short term) and International Collaboration
- Outreach activities: Dissemination of relevant information, development of courses and reference material in Geodesy. Extension of all laboratory support (equipment, training, library, SW, etc.) for students and researchers from universities and institutions and advise state/central government departments on various issues related to Geodesy
- Different areas of Geodesy Knowledge documentations

NCG has been involved in organizing several short-term courses, workshops, and training programs, signing Memorandum of Understanding (MoU) with various government and private institutions, as well as with industries. **An Autumn School on Physical Geodesy and its Applications** was organized, where Prof. Will Featherstone from Curtin University delivered lectures on Physical Geodesy. **A winter school on ‘Geospatial Technologies for Smart Cities and Urban Mobility’** was also organized, where Prof Stephen Winter from University of Melbourne delivered lectures on future urban mobility. Towards the establishment of the first **geodetic Very Long Base Interferometry (VLBI)** facility in the country, the NCG organized a VLBI workshop. Further, a **workshop on Satellite Gravimetry** was conducted to invigorate satellite gravimetry research in India, and join the global endeavour of launching a satellite gravimetry mission.

A low-cost GNSS receiver-based landslide monitoring system: The project aims to develop

a low-cost GNSS receiver-based landslide monitoring system, which includes a GNSS receiver and antenna unit, a real-time network adjustment software for the GNSS receiver network, and a WebGIS platform for presenting information and an android application. A network of low-cost GNSS receivers would be established to monitor landslide areas and disseminate the landslide risk using an Android app.

Academic activities: NCG currently supports MTech, MS and PhD programs to research scholars interested to work in Geodesy and relevant disciplines. Further, a one-year Diploma of IIT (DIIT) program is also being offered to working professionals. The program is already approved by the Senate of IITK.

IIT/NIT Geodesy Consortium: NCG organized online meeting and brainstorming sessions for establishing a Geodesy consortium with all the IITs and NITs.

Memorandum of Understanding (MoUs) with organizations: NCG has initiated the process of signing MoUs with national and international organizations. A memorandum of agreement (MoA) and MoU with survey of India (SoI) is finalized. For the Indian VLBI project, NCG is now signing a MoU with the National Centre for Radio Astrophysics. In addition to government organizations, NCG has actively participated in signing MoUs with industries working in the area relevant to Geodesy. A MoU with Earth Analytics India is finalized.



Fig. New building for the NCG at IIT Kanpur

ii. National Programme on Assessment of Regional Hydrological Systems using Space Borne Gravity Observations.

This National network project was developed involving 03 ministries and many knowledge institutions. At present, 12 R&D projects have been supported to various institutions to undertake research work. This networking programme represents a new opportunity to explore the feasibility of **monitoring total water storage variations from space**. The grace data enable the researchers to monitor the fluxes of water mass changes and exchange of water masses between the ocean and land ice masses.

A **Centre of Excellence** under the above programme was established at NGRI, Hyderabad. As a part of the programme initiation and its sustainability, this central facility has been

created to coordinate and integrate various components of the project, envisaged to evolve as a Knowledge Hub, and as solution provider to address hydrological problems at regional and smaller scale. This central facility which is a sort of virtual laboratory is expected to provide remote support to all the members of the network programme to augment data and data products from various sources.

Study of COVID-19 lockdown influence on terrestrial water storage in Vidarbha region, Maharashtra by Interdisciplinary Centre for Water Research and Department of Civil Engineering, Indian Institute of Science (IISc) Bangalore, Karnataka 560012, India

The above study was carried out as a part of the above networking project. Rapid COVID-19 spread has severely impacted normal life in Maharashtra state with > 37% of the total deaths along with > 21% of the total infections reported up to September 18, 2020. Most of the economic activities including agriculture have been stalled in the state. This provided an unique hypothetical-like scenario to study the natural hydrological cycle in parts of Maharashtra state. The first detailed documentation of the impact of the pandemic linked lockdown on terrestrial water storage patterns was carried out along a major part of drought prone central India. The study area covers the infamous Vidarbha region of Maharashtra state, India. Largest number of farmers suicides in India have been taking place in Vidarbha region due to crop failure. Water shortage plays an important role in crop failure as the subsurface mostly covered by basalt with less productive fractured aquifers underlying it. Long term study (between April-2002 and May-2020) of terrestrial water storage anomaly (TWSA) in ~115,000 km² area and delineated the crucial factors (i.e. policy measures and precipitation) controlling TWSA at the region was carried out. Using multiple advanced statistical analyses, a net rise of 3.65 to 19.32 km³ TWSA during May-2020 as an outcome of the pandemic linked lockdown in this water scarce region was estimated, where millions of dollars has been already spent by multiple agencies including the World Bank to improve the water storage scenario.

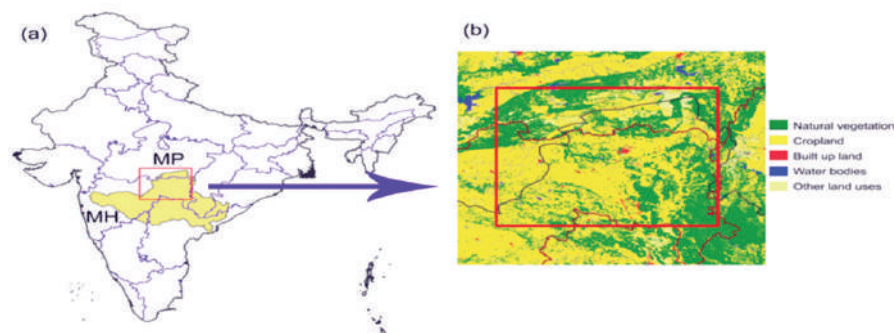

Fig. (a) The study region is marked in red line. Administrative boundaries of Indian states (MH: Maharashtra; MP: Madhya Pradesh) and the Godavari river basin are shown. (b) Land use land cover of the study region

iii. Geospatial Solutions Addressing National Priorities and Sustainable Development Goals

Geospatial Solutions for Urban Governance: Under this sub-programme proposals are

supported in the areas of city governance applications as well as in the core R&D areas focusing on emerging technologies related to city development using Geo-ICT. Out of total 18 R&D projects, around 08 projects were supported this year focusing on Smart Parking Management System using sensors, IoT and GIS technologies; Framework for flood mapping and or prepare an early warning system in the occurrence of flood; City GML based 3D models for smart cities; Industrial Indoor Assets Positioning and Navigation System using Geospatial Analysis; Geomagnetism based Indoor Navigation system etc. Few highlights of the work supported under the above Sub-programme are as follows:

Automatic Discovery and Construction of Building Information Model by School of Computer Sciences, NISER Bhubaneswar, Odisha

In this project, prototype buildings as well as automatic discovery of the buildings from the pictures and then geo-mapping of the same were carried out. Automatic discovery and geo-mapping is essential for mapping our already build cities and planning for the same. It is harder to get 2D models of our cities/building and even harder to get 3D models. This would help in understanding and analysing the requirements of cities/towns more effectively; for example; planning containment zones, understanding critical infrastructure requirement, emergency evacuations, etc.

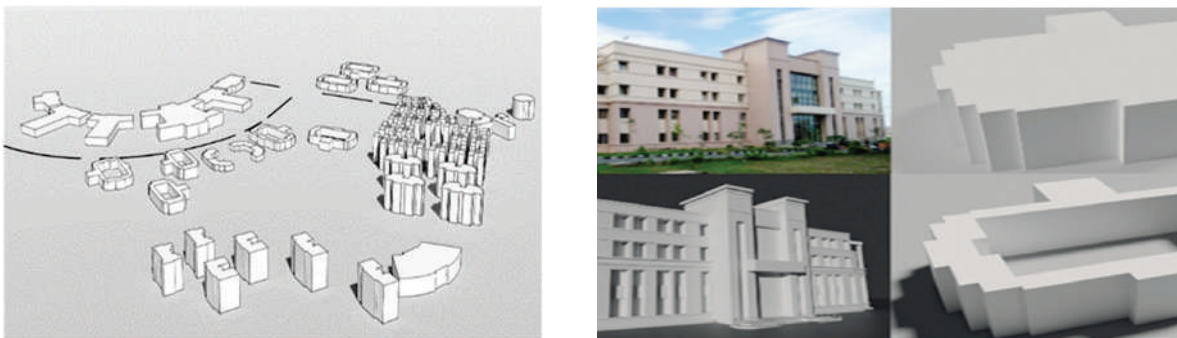

Fig. (a) Sample prototype for NISER Bhubaneswar campus, Odisha. (b) Sample prototype for a building with levels of detail for mapping.

Deep Learning-based Critical Infrastructure Simulation Model for Disaster Monitoring developed by Centre of Studies in Resources Engineering (CSRE), Indian Institute of Technology Bombay

Flooding has a significant impact on the Critical Infrastructure (CI) services. Due to the increasing flood levels, the CI infrastructure services such as Healthcare, Electric supply, Water supply, etc., get disrupted. The functioning of these services during the disaster event is vital for the well-being of society. A deep reinforcement learning-based model enables the complex system to learn from an adaptive environment using feedback from the present state of the system. The CI systems are modeled as intelligent geospatial CI agents, and the interdependencies are modeled using various policies.

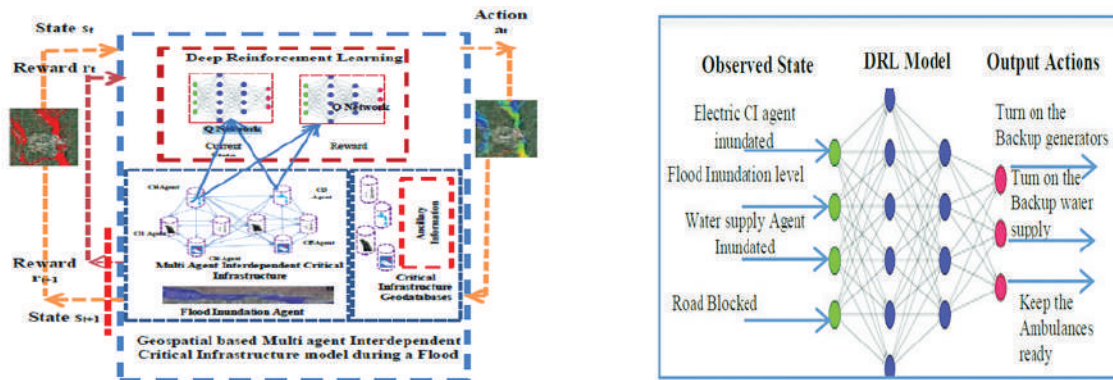

Fig. Architecture of a Deep Learning (DL) driven multi-agent based Critical Infrastructure(CI) protection for real-time situational awareness; (b) Deep reinforcement (DRL) model in a multi-agent interdependent CI network

The IC Infrastructure model during a flood disaster consists of geospatial agents representing the CI facilities such as (Hospital, Electric substation, Water Pumping station, transportation, etc.). The Interdependent CI network is set up in a spatiotemporal environment during a flooding event. Each Geospatial based CI agent learns from the various experiences by interacting directly with the environment, in the context of its environment. The CI agents are developed to act intelligently and assigned to a deep reinforcement (DRL) model in a multi-agent interdependent CI network

The simulation model is integrated with a web portal and receives inputs from the user via a Dashboard on it. These inputs are used to initialize the simulation model. The web portal helps visualize the state changes of the CI facilities as per the timeline provided by the user.

iv. Geospatial Solutions for addressing SDGs.

Geospatial Applications for the Land Consolidation system: The project of GIS and soft computing based Land consolidation system was supported to Indian Institute of Technology, Kanpur with the following outputs:

- Different mapping techniques have been investigated and project came out with the best technique which is efficient, cost effective and acceptable (in terms of accuracy) for updating land records
- GIS database has been developed to store, manipulate, analyze, manage, and present all types of spatial and non-spatial data for land consolidation
- A comprehensive land valuation system has been developed by integrating GIS and Soft computing techniques
- A comprehensive land rearrangement system has been developed for sector based land allocation under GIS environment

- A comprehensive land partitioning system has been developed for land consolidation under GIS environment. State Government is supporting the activities at present and keen in adoption of a complete automated system for land consolidation.

Revival of Village Ponds: Village ponds are the lifelines in rural areas as they play a vital role for water conservations and ground water recharge at local level. It has been seen that most of the ponds are not functional. This led to scarcity of water and increase run off. In order to address this issue, division has developed a sub-programme on revival of village ponds by supporting 12 R&D projects. The findings of all the projects in networking mode are being integrated in the form of Guidebook. The task of preparation of Guidebook has been assigned to the National Institute of Hydrology. This will be an outcome of the work carried out on rejuvenation of village pond by all the institutions/agencies including networked projects supported by DST, work carried out by National Institute of Hydrology (NIH) and the best practices followed by any other agency in this regard in India. It is very important outcome for the National flagship programme of Jal Shakti Mission also. Hon'ble Prime Minister of India also emphasized the need for water conservations and particularly revival of ponds at panchayat level.

National Programme on Spatial Disaster Risk Reduction (SDRR)

Division has taken the new initiative for developing an integrated National Programme on Spatial Disaster Risk Reduction (SDRR) with reference to National Disaster Management Plan (NDMP). A brainstorming session has been organized on 30.07.2020 to develop the programme on spatial disaster risk reduction. In this direction the division has already initiated the following sub-programmes viz. landslide hazard mitigation and coastal hazard risk reduction.

Landslide Hazard Mitigation (LHM)

Landslide Hazard Mitigation is a multi-disciplinary and multi-agency programme being coordinated by division. Division is supporting R&D projects in LHM to address issues like landslide hazards and risk assessment, monitoring of critical landslide zones, developing prognostic models for slope stability and design of suitable remedial measures, training/dissemination of technologies. During the Science congress, 2019, Honorable Prime Minister emphasized the need to develop an early warning system for landslides particularly for North Eastern States and Himachal Pradesh/ Uttarakhand states. NGP has supported 7 R & D projects for development of an early warning system in the year 2020.

Landslide hazard mitigation for North-Eastern Region (NER)

NER is important from strategic point of view for the country. The entire hilly terrain experiencing landslide hazards and disrupt the vehicular traffic in the monsoon season. In order to tackle such, a Network Programme for this region was developed with the participation of the institutions/universities of these states. The focus was the identification of the active/unstable

slopes and carrying out scientific analysis for developing suitable remedial measures. Various institutions from six states of NER (Meghalaya, Nagaland, Mizoram, Tripura, Assam and Manipur) participated in the Networking programme of Landslide Hazard Mitigation. Geotechnical Training Programme was organized at Indian Institute of Technology (IIT), Guwahati. Twelve networking projects from above states have been supported by DST (**Figure 7**). The manpower of these projects was trained in Geotechnical field and lab Training and Large-scale mapping programme to collect the standard data on individual landslide for geotechnical solutions for mitigations. The major findings of the programme are as under:

- Influence of geomorphologic parameters on slope stability
- Geotechnical Characterisation of Study Area
- Rainfall – Soil Moisture Variation Data of the Study area
- Rainfall Threshold for Landslide Initiation
- Preparation of geological profiles and identification of role of structures in causing landslides
- Interface with the line department of the concerned state and state disaster management authority.
- Identification of slip surface and slope failure & Mitigation/remedial measures



ig. Representing landslide site and Township in Noklak Town

The above programme will provide geotechnical solutions for active landslide to various user agencies State Public Work Departments (PWD) and Border Road Organization (BRO), who are involved in maintenance work of highways in the north eastern states.

National Geotechnical Facility (NGF): In order to develop soil and rock mechanics, testing facilities, NGF has been set up in Survey of India, Dehradun. The advanced data acquisition instruments like ground penetrating radar, drone and other testing facilities to estimate the shear strength of the material were also developed. NGF is the state of art facility in geotechnical engineering. Now it has been handed over to the Survey of India by DST.

Coastal Hazard Risk Assessment (CHRA): CHRA has been initiated to cover the coastal areas of India with the aim to develop S&T enabled techniques for coastal disaster studies encompassing disaster genetics, propagation, disaster vulnerability mapping, detection of causative factors, mitigation measures etc. and come out with quantifiable/actionable outputs so that the state governments and the stake holders can readily use them during the disasters for relief, restoration and rehabilitation. **10 R&D projects** have been supported so far in the areas of Land subsidence and Sea level rise, tsunamis, cyclones, floods and coastal erosion etc. since the inception of the programme.

Development of high-resolution Coastal Relief Model (CRM) that combines coastal topography and near-shore bathymetry, using low-cost drones and satellite imageries, a demonstrative research study carried out by Dept. of Civil Engg., IIT Bombay under the aegis of DST-CHRA funding scheme. CRM will enhance the accuracies of coastal inundation estimations associated with cyclones and other extreme events.

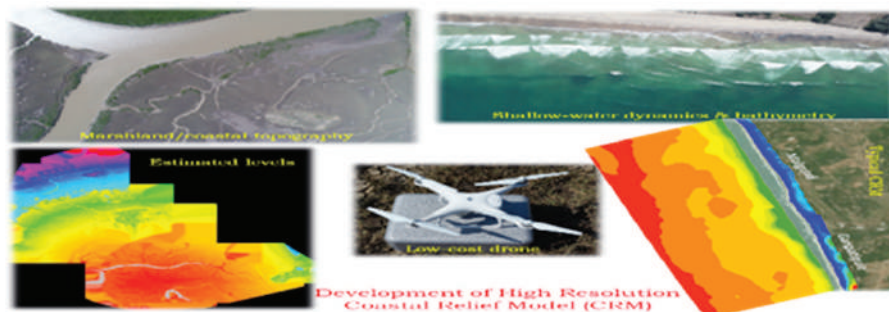

Fig. High Resolution Coastal Relief Model (CRM)

Capacity Building Programme

The capacity building program of NGP has evolved into a strong program that has over the **last ten years conducted 166 programs** of three week duration, incorporating classroom, lab and field sessions with a mini project conducted across the length and breadth of the country benefitting **over 5000 participants** from academia, Government and research institutes across India (**Figure 9**). A structured curriculum and promoting the use of open source software **through a dedicated portal (www.dst-iget.in)** as an one stop resource for teaching-learning geospatial science besides networking educators, professionals and scientists has ensured adoption of geospatial technologies contributing to strengthening India's geospatial ecosystem.



Fig. Group photo of resource persons and participants in one of the 21 days training

New Initiatives

From this year two new initiatives viz. '**Geo-innovation Challenge**' for harnessing new ideas in Geospatial Science, Technology and entrepreneurship and **a special call for SC/ST category** under 21 Day summer/winter schools in geospatial science and technology (Level-1) have been launched.

International Collaboration

This programme aims to develop the national capacity for Geospatial technology development, acquisition and transfer through international partnerships/collaborations namely United Nations Global Geospatial Information Management (UNGGIM), Open Geospatial Consortium (OGC), Brazil Russia India China South Africa (BRICS), Indo-Africa collaborations etc. The following activities through UNGGIM collaborations were carried out during last year:

- Divisional officials participated in UN-GGIM Virtual High- meeting on 'Geospatial Landscape, and overview of Integrated Geospatial Information Framework and Future Trends in Geospatial Information Management' held on 26th May 2020. It was envisaged that participation will help in developing a Roadmap/ Strategy for augmenting National activities in alignment with UNGGIM priorities.
- Indian delegation participated in the annual Tenth virtual Session of the UN Committee of Experts on Global Geospatial Information Management (UN-GGIM), held online for 26-27 August and 4 September 2020, respectively. Extensive consultation from experts (Ministries/ departments etc.) was sought for preparing the Statements for the agenda items of above tenth UNGGIM session. After approval, these **Statements were uploaded on UNGGIM Website**.
- Country Report 2020 was prepared which was uploaded at UNGGIM website.
- Detailed proposal for bidding to host the Second United Nations World Geospatial Information Congress (UNWGIC) in India in year 2022 was submitted to UNGGIM Secretariat.

New Initiatives taken by Geospatial Community of DST in view of COVID-19 Pandemic

Since the outbreak, it was envisaged that there is a need to develop a robust, scalable, sustainable, integrated Geospatial Infrastructure that will seamlessly bring together varied data sets for different organizations in real-time, providing actionable solutions to any governance problem to not only address the COVID 19 related issues but also similar disasters in future. Keeping this in mind, division has put lots of efforts for addressing the issue by organising many relevant virtual meetings, brainstormings, trainings etc. with heads and officials of the Geospatial Organizations and divisions of the DST. The details are as follows:

- In a response to combat COVID-19 pandemic related challenges, NGP-DST

- along with efforts of Geospatial Chair Professors, have made efforts to develop an integrated Geospatial platform to integrate available geospatial datasets, standards-based services, products, applications; and analytic tools from its attached offices (Survey of India (SOI), National Atlas & Thematic Mapping Organisation (NATMO) and NSDI). The platform is initially expected to strengthen the public health delivery system of the State and Central Governments, and subsequently provide the requisite geospatial information support to the agencies concerned with the critical process of recovery out of the COVID-19 crisis situation.
- www.indiamaps.gov.in/soiapp/ portal of SOI is available as the core of the integrated geospatial platform to address COVID-19 outbreak and its socioeconomic impact. For required data collection pertinent to COVID emergency management, the SAHYOG mobile app, developed and managed by SOI has been customized to collect COVID-19 specific datasets through community engagement to augment the COVID-19 response activities by GoI. Recently additional features such as isolation centre, designated COVID-19 hospitals, details of the migrating population etc have been added to the app, after intensive discussions with various experts Figure 10. The collected data is hosted on the above platform and for that a POI (point of interest) has been also created.
- The NGOs of the DST-SEED division were trained towards using of Sahyog App of SOI for data collection at the ground level so that the output can be scaled up as per the current needs of the stakeholders in the COVID-19 scenario. To facilitate this, a Virtual training on 'Data based intervention by NGOs for economic regrowth at community level in COVID-19 scenario' was organised in May 2020. Further, for facilitating the Data integration process, APIs (Application Processing Interface) for the 28 NGOs have been created and shared with them.

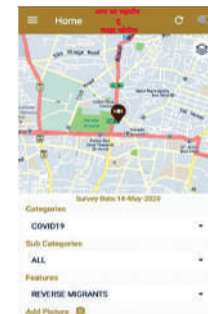

Fig. Screen shot of Sahyog mobile App of Survey of India depicting the added feature of reversed migrants

Efforts has been made to strengthen the area of geospatial analytics capabilities of the country. **Call for proposals (short-term) has been issued to address the COVID-19 crisis in Collaboration with AGNiI** (Accelerating Growth of New India's Innovations) initiative of office of the Principal Scientific Adviser to the Government of India under the Prime Minister's Science, Technology, and Innovation Advisory Council PSA office for strengthening Geospatial analytics capabilities of the integrated platform, as well as addressing the issues of migratory workers in the sectors of migration, employment generation, strengthening of livelihood, resource mapping for community resilience etc.

In the Uttarakhand State all the COVID-19 related data available is being converted into GIS mode. Sahyog App of Survey of India is also being used by the various GIS centers in the districts. State is already having district level geospatial maps, databases.

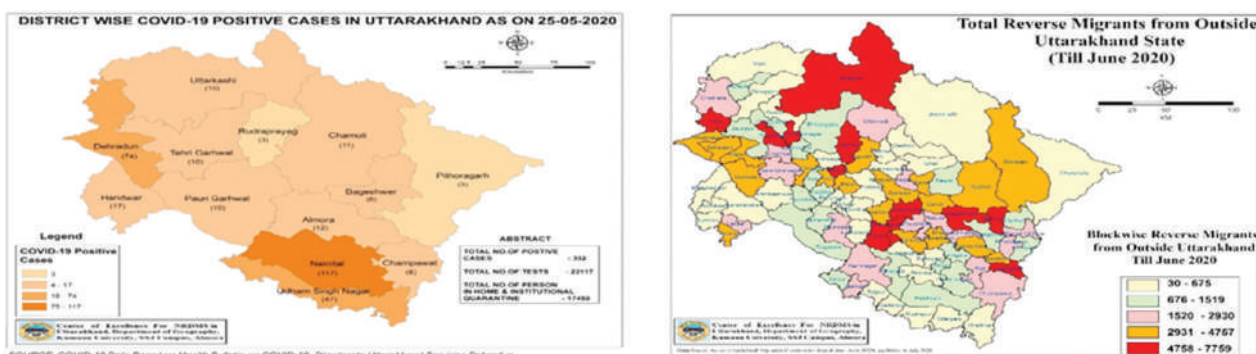

Fig. (a) District wise COVID-19 cases in Uttarakhand (b) Block-wise reverse migrants from outside Uttarakhand State (till June 2020)

The various activities related to GIS development of COVID-19 outburst in the Uttarakhand State are as follows:

- Geotagging of dedicated COVID-19 Centres/ isolated COVID-19 Centers and institutional quarantine centres with their attributes
- Details of 618 Reversed Migrants have been collected such as, travel history, place of migration, cause of migration, education level, technical skill, marital status, income at migrated place, income at home, what wants to do now, expectation from government etc.
- GIS based district wise mapping of COVID-19 spread pattern is being done on weekly basis; Monitoring/ mapping of district wise daily trend of infected, deceased, tested, and recovered cases is in progress; Mapping of home quarantines is also being done

3.4 National Science & Technology Entrepreneurship Development Board (NSTEDB)

The National Science and Technology Entrepreneurship Development Board (NSTEDB) of the Department of Science & Technology through its strong network of incubators is leveraging the technological strength of the higher learning institutes to the benefit of the start-ups. The efforts of NSTEDB for nurturing national innovation and entrepreneurship ecosystem has yielded both positive outcomes and impact. NSTEDB has adopted a multipronged approach by targeting its program offerings into the following ecosystem subcomponents (or fronts).

3.4.1 Front I : Capacity Building & Training Programs for Potential Entrepreneurs



Technology Entrepreneurship Development Program (TEDP) and Women Entrepreneurship Development Program (WEDP)

TEDP and WEDP are two of the direct and targeted training modules by NSTEDB. These are long duration programs of more than 4 weeks up to 8 weeks regarding techno-managerial business aspects of starting a new venture.

Faculty Development Program (FDP)

FDP is a Training the Trainer kind of Module. Faculties who could carry out the entrepreneurial training further, get 2-3 weeks of training. In the year 2020-2021, the TEDP, WEDP, and FDP programs were conducted at 147 institutes, impacting more than 59 thousand individuals.



22k Individuals trained



22k Women Trained



15k Faculties Trained

Front II: Innovation Scouting & Support- PPP Programs

DST-Lockheed Martin-Tata Trusts-India Innovation Growth Programme(IIGP) 2.0

The India Innovation Growth Program (IIGP) 2.0 is a unique annual partnership programme of the Department with the leading US Aerospace Company Lockheed Martin Corp. and the Tata Trusts, which aims to offer an enabling platform to tap and support and scale up technology based innovations in the country. Owing to the COVID-19 pandemic and lockdown, this year the Demo Day; for the awardees of the Open Innovation Challenge; was held virtually over 30th and 31st July 2020.

Funding Partners



TATA TRUSTS

Implementing Partners



IIGP's University Challenge (UC) and Open Innovation Challenge (OIC) has generated following impacts:

Post the IIGP 2.0 funding of INR 14.9 Crores, the teams were able to leverage over 2.8 times funding from external sources amounting to INR 42.83 Crores. Two-fifths of the UC awardees and more than half of the OIC awardees have registered their companies post exposure to the programme. 56% of total awardees across UC and OIC have been granted patents for the innovation awarded under IIGP 2.0. 47% of the OIC awardees have been able to commercialize their awarded technology in the market. 62% of UC awardees and 37% of OIC awardees have developed strategic partnerships with companies and universities in India; and 10% of UC awardees and 37% of OIC awardees have developed strategic

partnerships with companies and universities outside India. 3 startups piloted/implemented their solutions with different departments of Tata Steel.

Millennium Alliance

The Millennium Alliance was conceived in 2012 as a platform to identify, test, and scale technological innovations that provide affordable, accessible solutions to the BoP populations. Given the success of the program, U.K's Foreign, Commonwealth & Development Office ("FCDO"), World Bank Group, Facebook, Marico Foundation and UnLtd subsequently joined the platform providing financial and knowledge resources.



In 2020 the Alliance has awarded 33 Indian innovators under the program with close to INR 18 Crores, with INR 3.2 Crores being DST's contribution. Under the current round, the Alliance also held an exclusive innovation challenge for Covid-19 related technologies and shortlisted 16 Indian innovations which were also supported with a funding of INR 9.5 Crores. The Covid-19 challenge received an overwhelming response with 400+ entrepreneurs applying within a short application time of 15 days.

Women Entrepreneurship and Empowerment (WEE)



WEE is an exclusive, free of cost mentorship program of 4-6 months to empower and encourage women entrepreneurs. The 5th Cohort of WEE, conducted at IIT Delhi, was supported by NSTEDB started in January 2020 with 45 women Entrepreneurs. Each year DST grants a total of Rs. 25 lakh award money (per cohort) to the women entrepreneurs.. Eleven Women entrepreneurs were awarded for their excellence in the current WEE 5 cohort. Nine of these eleven have started making revenues.

This year's cohort was an eclectic mix of entrepreneurs aged 20- 55 years. The group had 9 women entrepreneurs with Ph.D. 's and other specialists in their specific fields. Three Patent filings have been initiated through this cohort. The cohort saw participation from women entrepreneurs coming from 16 different states all across India (From Himachal Pradesh, to Gujarat to Mizoram to Aurangabad, to Karnataka)

PLUGIN - Only National Hardware Accelerator Program

Plugin is the only national Hardware accelerator program jointly organized by NSTEDB-DST,

Intel India and Society for Innovation & Entrepreneurship (SINE)-IIT Bombay. The mission of Plugin is to support and contribute to the innovative deep-tech startup ecosystem in India. Plugin was initiated in the year 2016, and three editions of Plugin have been completed. Highlights of the Program are:

The demo day of Plugin edition 3 was held completely virtually for the first time on November 7th, 2020. Three startups have raised \$5M as pre-series A:

- Wobot Intelligence - Raised \$ 2.5m from Sequoia Capital
- Inflect Technologies – Raised \$1.5m Pre-Series A
- CamCom – Raised \$1m Pre-Series A

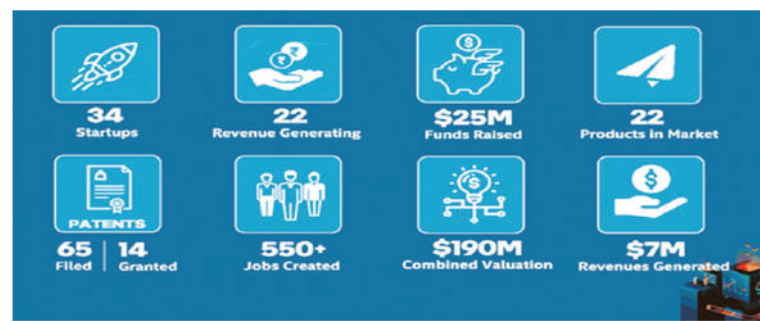

Three startups re-purposed their technology to new use cases during COVID-19. Two startups viz. Haystack Analytics and Vacus Technologies got selected for the CAWACH grant from NSTEDB. Eight startups have large-scale deployment revenue streams. Plugin seed funding component of Rs. 1.6cr was given to top 3 startups

The India Innovation Challenge Design Contest (IICDC)

The India Innovation Challenge Design Contest (IICDC) has grown from strength to strength every year since its inception in 2016. An initiative by Texas Instruments India in collaboration with NSTEDB and anchored by NSRCEL@IIMB, supported by MyGov and NIC, IICDC is the platform to enable the design thinking and creativity ecosystem. With All India Council for Technical Education (AICTE) onboard, there was greater participation of Engineering students nationwide, in the design contest. After evaluation, prototyping and validation support is offer to semifinalists a, while top 10 final winners are offered incubation with seed funding at NSRCEL, IIMB. The four editions of IICDC saw participants file over 175 patents. In the wake of the COVID19 pandemic, few IICDC start-ups are working on providing solutions with the learnings they had from the IICDC programme. The unutilized fund from IICDC has been repurposed to support these start-ups.

3.4.3 Front III: National Initiative for Developing and Harnessing Innovations- NIDHI

The umbrella program of the National Initiative for Developing and Harnessing Innovations

(NIDHI) aims to nurture start-ups through scouting, supporting, and scaling of innovations. The key stakeholders of NIDHI include various departments and ministries of the central government, state governments, academic, and R & D institutions, mentors, financial institutions, angel investors, venture capitalists, and private sectors. The key components of NIDHI Umbrella (Refer: Figure) are –

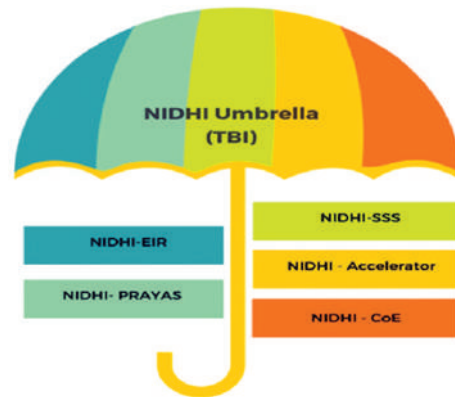

1. **NIDHI-Technology Business Incubator (NIDHI-TBI)** Converting Innovations to Start-ups.
2. **NIDHI-PRAYAS (PRomotion and Acceleration of Young and Aspiring Technology Entrepreneurs.);** Support from Idea to Prototype.
3. **NIDHI-Entrepreneur In Residence (NIDHI-EIR);** Support system to reduce risk.
4. **NIDHI-Accelerator-** Fast-tracking a start-up through focused intervention.
5. **NIDHI-Seed Support System** - Providing early-stage funding
6. **NIDHI Centres of Excellence (NIDHI-COE)-** A World-class facility to help startups go global.

NIDHI TBI

NIDHI TBI are ecosystem institutions that are a one stop solution for the start-up's in their early vulnerable years. TBI's support is invaluable in supporting and nurturing a start-up by providing access to critical resources during their most vulnerable stage in their lifecycle. TBI's assume the role of an implementing agency for the diverse govt. schemes and programs. Apart from that, they also have the freedom of an autonomous entity to effectively support start-ups with commercialisation and marketing assistance.

During the year 2020-21, NSTEDB is extending support for establishing seven new TBIs under NIDHI program: NIT Raipur, Gujarat Technical University (GTU), Ahmedabad, Bharath Institute, Chennai, Shri Vishnu Engineering College for Women- Bhimavaram (AP), G pullaiah

College of Engineering, Kurnool AP, Lovely Professional University, Phagwara, Punjab, and IIT Ropar

Number of New TBI Supported	7
Total fund disbursed to NIDHI-TBI	Rs. 50+ Crore
New Incubatees On Boarded across existing and new TBIs	500+

Startup story supported under DST supported TBI's

Roboticswares Pvt Ltd. 

A KIIT Bhubaneshwar incubatee company, established to develop real time tracking, monitoring and alert system for automobile industry.

Company supported with TDB Seed fund of 10 lakhs for market validation and scale up in 2013.

- In April 2020, the company raised a Series D investment of \$25 million
- No of Employees: ~300+
- Total Valuation: Over Rs. **3000 Crore.**

Ecofrost Technologies Pvt. Ltd (<https://ecozensolutions.com>) 

- Ecofrost is an agri-focused company creating solutions to overcome problems in cold chain infrastructure.
- The STEP, IIT Kharagpur incubatee envisions disrupting the current state of food supply chain in India by empowering farmers, mandi owners and mobile cold chain players with clean technology for a sustainable future.

Status:

- The product won Dow Sustainability Innovation Challenge at California Institute of Technology, Pasadena
- **The idea won Economic Times-Power of Ideas award from DST, Govt. of India organized by CIIE, IIMA**
- The team is the winner of Technology and Sustainable Development Award 2011 at Eureka IIT Bombay
- Micro Cold storage is among world's top 30 business ideas at Stanford's E- bootcamp

- No of Employees: ~150
- Total Turnover: Over Rs. 34.50 Crore

NIDHI-PRAYAS - <https://www.nidhi-prayas.org/>

NIDHI-PRAYAS grant focuses on addressing the funding gap from idea to prototype and it is positioned as a pre-incubation initiative. The program is implemented by PRAYAS centres (PC) across the country. Each PC gets funding support for a period of five years. Currently NIDHI-PRAYAS program is in its third year and a total of 31 centres across the country are implementing the PRAYAS program. Currently selection of the innovators for third year is under way at various centres. Around ~ 3500 applications were received by all 31 centres in the span of 3 years, of which 500+ innovators are being supported till date across the country. More than 200 prototypes have been successfully developed. These innovators have made progress towards IP filing and 200+ patents have been filed, and some of them further raised funding cumulatively more than Rs. 120 Crore, generating revenue around Rs. 23 crores. Further, such support will be more critical to encourage entrepreneurship at the higher scale given the economic scenario post covid-19 related crisis.”

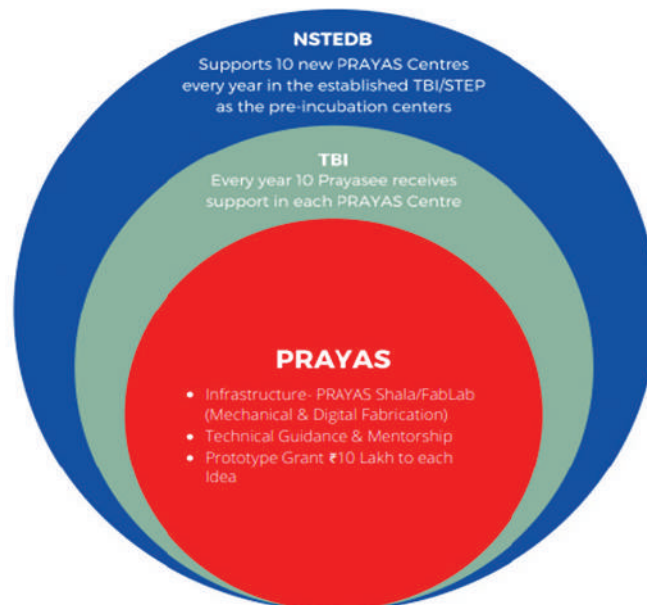

Few Startup Stories supported under NIDHI PRAYAS schemes are:-

SquatEase (Sanotion Private Limited)

Understanding the problems faced by Indians while using a squat toilet, 26-year-old Satyajit Mittal, a student of Product Design and alumni of MIT Institute of Design has come up with

a unique innovation – SquatEase – unidirectional, clean and comfortable toilet solution. No. of Patents: 5



Recipient of NIDHI PRAYAS Grant worth ₹10 lakh from Prayas Centre, STEP, Pune.

Awards and Recognition:

- Swachh Bharat Puraskar 2018 by Prime Minister Narendra Modi and UN Secretary General
- Prayaraj Kumbh: Got tender to install 5,000 SquatEase toilets.
- INR. 1 crore + revenue generation in their first year itself (product priced at Rs. 999).

NIDHI EIR Programme - <http://www.nidhi-eir.in/>

Entrepreneurs-in- Residence (EIR) Programme under NIDHI supports aspiring or budding entrepreneur ventures out and pursues daring entrepreneurial ideas as well as enhances the quantity and quality of startups. The program is implemented via Venture Center, Pune as Program Implementation Partner and 22 other DST recognized TBIs/STEPS as Program Execution Partners. Total funding amount of Rs 1548 lakh has been disbursed from DST to PIP under the first three rounds of NIDHI EIR. So far three rounds have been launched and a total of 40 PEPs (22 unique TBIs) from 12 states of India participated in implementation of the program. Under round 3 support is provided under General, SC and ST categories separately and the implementation has begun in third quarter of FY 20-21. Impact matrix as of 20th December 2020 of the of the first two rounds of the NIDHI EIR program is given below; we further expect these numbers to grow as the business ideas mature:

- 230 EIRs supported
- 158 companies formed
- More than Rs 3532 lakh of follow-on funding and investments raised (more than 4X amount invested by DST for Round 1 & 2)
- ~12% EIRs are women entrepreneurs
- 142 IPs generated (includes 65 Patents, 58 trademark and 19 copyrights)

irrigation solutions which allow crops to take water when required with the help of wireless sensors and communication system without any human intervention using Internet of Things (IoT), Artificial Intelligence (AI) and Machine Learning (ML).

NIDHI Accelerator

In its quest to accelerate growth-stage startups, DST supports NIDHI Accelerator programs every year. So far, NSTEDB has supported 417 startup companies through its 27 accelerator programs conducted at various Technology Business Incubators(TBI) across the nation, in last four years. NIDHI Accelerators are positioned as post-incubation initiatives linked with the existing incubators to supplement, complement the scaling up of the start-up value chain.

Under the NIDHI-Accelerator Program, twelve new programs were supported to boost the provide a quality mentorship program enabling start-ups to build a customer centric validation model which enhances their investment readiness as well as market access. These 12 Accelerator programs were supported in the areas of Digital technologies, Digital payments, Climate Change, Energy, Entrepreneurship and Innovation, Health, Waste Processing, Water, Health tech start-ups Manufacturing Sector, AgriTech, CleanTech, Food Tech, Health & Sanitation, benefitting more than 220 startups

NIDHI - CoE (Center of Excellence)

To further augment and scale up existing incubation activities to provide end to end support by hi performing TBIs, the Department provides an enhanced support of Rs.50 crore in 5 years for setting up of an augmented Incubation centres viz NIDHI-CoE (Centre of Excellence) with state of the art and scaled up incubation spaces. The CoEs offer, better infrastructure, quality mentorship, market insights and outreach, domestic and global connects, networks and resources as key offerings in ever evolving startup ecosystem within a region to create multifold increase in outcomes and impact annually as compared to a regular TBI. The ongoing six CoEs are functional at PSG-Science & Technology Entrepreneurial Park (PSG-STEP) at PSG-College of Technology, Coimbatore, SINE IIT-Bombay, CIIE-IIM-Ahmedabad, TBI-Veltech Univ., EDC NCL-Pune. In 2020-2021, support to two more NIDHI-CoEs is underway at FIIT, IIT Delhi and T-Hub, Hyderabad.

Till now more than 1000+ startups have been nurtured through all the CoE till 2020.

Few success stories:

1. BoHeCo - Bombay Hemp Company, startup nurtured under CIIE, Ahmedabad, CoE is an Agro-based enterprise reimagining the future of Indian agriculture and sustainable living with hemp. BoHeCo is a social enterprise that promotes industrial hemp. They have raised more than \$90 Mn+ till now.
2. ChitMonks is India's FIRST and ONLY online marketplace for promoting chit fund companies. They have raised \$ 650,000 from external investors, they were nurtured under CIIE, Ahmedabad, CoE.

3.4.4 Front IV: Internationalisation & Market Access

Academia-Industry Training (AIT) Program

The “Academia-Industry Training” (AIT) Program is an initiative funded by Department of Science and Technology (DST), Government of India and the Indo-Swiss Joint Research Program (ISJRP) of State Secretariat for Education Research and Innovation (SERI), Switzerland, to promote research and technological entrepreneurship. AIT has been successfully conducted for 6 years now and 6 cycles have been completed with the help of DST.

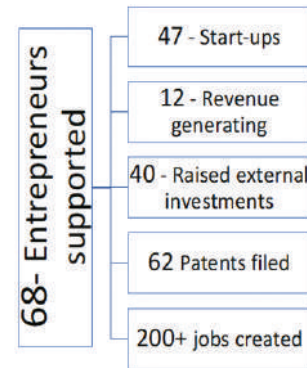

Society for Innovation and Entrepreneurship (SINE), IIT-Bombay and swissnex India are the co-organizers for the AIT program with help of Venture Lab, and Zürcher Hochschule für Angewandte Wissenschaften (ZHAW) is the Leading House in Switzerland. The format of AIT involves a boot camp held in both countries, 1 week in India and 1 week in Switzerland in two phases. The main aim of AIT is to enhance the interaction of academic researchers/innovators with the industry as well as connect both the countries towards joint research and eventual commercialization.



Fig: Products developed by AIT innovators

Maitri-Indo Brazil Agri-tech Cross Border Incubation Program

Maitri - Indo Brazil Agri-Tech Cross Border Incubation Program. This is the unique and first of its kind cross-border incubation program which focuses on promoting agri start-up incubation, start-up exchange and access to global market thereby enabling the social, industrial and economic growth of both countries.



Fig. Glimpse of the Program:-

Indian startups	Brazilian Startups
Silage Agro Pvt. Ltd., www.silageagro.com	TNS Nanotecnologia, www.tnsolution.com.br
Aegipan Animal Biocare (P) Ltd., www.sanjevanigoats.com	Decoy Smart Control, www.decoysmart.com
Zentron Labs (P) Ltd., www.zentronlabs.com	4milk, www.4milk.com.br
Satyukt Analytics (P) Ltd., www.satyukt.com	Tau Flow, www.tauflow.com
Natura Crop Care, www.naturacropcare.com	DigiFarmz Smart Agriculture, www.digifarmz.com

As per the program structure under phase-1, 5 Brazilian companies visited India during 9-12 December, 2019. These Brazilians and Indian start-ups underwent a market access program in Delhi at Pusa Krishi Incubator at Zonal Technology Management and Business Planning and Development Unit (ZTM-BPD Unit) of IARI for seven days.

Under phase-2, the Indian startups were expected to visit Brazil in the last week of April, 2020, to engage with the ecosystem partners like incubators, start-ups, venture capitalists etc. The Indian start-up will benefit from this program by gaining access to the international market in Brazil through customers, collaborations and networking but due to COVID-19 pandemic the visit of Indian startups was postponed.

India- Russia Joint Technology Assessment and Accelerated Commercialization Programme

The India-Russia Joint Technology Assessment and Accelerated Commercialization Programme is a bilateral initiative of India and Russia which aims to create an ecosystem

wherein innovative Indian and Russian S&T led SMEs, Start-ups and Enterprises come together to drive B2B/B2G/B2C business ventures. The programme is a joint initiative of the Department and Foundation for Assistance to Small Innovative Enterprises (FASIE). On the Indian side, FICCI would be implementing this programme on behalf of DST. The thematic areas chosen are IT & ICT, including AI, AR, VR, Medicine/Pharmaceuticals, Renewable Energy/Clean Technologies/Alternative Technologies, Aerospace, Environment, NewMaterials, Biotechnologies, Artificial Intelligence, Robotics and Drones.

3.4.5 Front V: Additional Efforts To Support Growth and Innovation

Resurgence TiEcon Delhi-NCR - 27th – 30th January, 2021

TiE Delhi – NCR opens the fully online #Resurgence TiEcon Delhi – NCR. It promises to be one of the largest conferences for entrepreneurs anywhere in the world and the most exciting platform for knowledge sharing, networking and mentorship for entrepreneurs.

NSTEDB, DST, Gol is the knowledge partner for the event, where we have been supporting them with delegates and renowned speakers from government and industry, also financially. **#Resurgence TiEcon 2021** will look at the future and bring conversations on new growth avenues of entrepreneurship to recover from this crisis and tread the trajectory of growth success and market leadership.

CAWACH - Centre for Augmenting WAR on Covid 19 Health Crisis

To tackle the extraordinary situations created by the pandemic, Indian Science and Tech startups joined forces and came out with extraordinary responses. NSTEDB as a rapid response rolled out a new program CAWACH (Centre for Augmenting WAR on Covid 19 Health Crisis) in March end 2020. Visualizing the gravity of the pandemic situation, and the necessity for an early outcome to combat the pandemic, the program was launched with an objective to support innovations/startups having solutions to address/mitigate various challenges faced due to the impact of COVID19. The program aimed to support startups in the areas of Diagnostics Drugs, Disinfectants, Sanitizers, Ventilators, Medical Equipment, PPEs, and Informatics.



CAWACH
Centre for Augmenting
War with COVID-19
Health Crisis

**COME JOIN CAWACH
TO LEAD A WAR
AGAINST CORONA**

CALLING STARTUPS, INNOVATORS & INDIAN
COMPANIES TO BRING YOUR INNOVATIONS TO JOIN
THE WAR AGAINST COVID19. CAWACH WILL HELP IN
ACCELERATING YOUR PRODUCT ENTRY TO MARKET

FUNDING
₹ 50 Lacs - ₹ 2.0 CR
(-₹ 1 Cr)

Extraordinary situations demand extraordinary responses

Total 51 startups with Covid 19, market-ready solutions are being supported and scaled with financial support. Few products supported under the CAWACH program, are:



Noccarc Robotics



Ayusynk



Jeevtronics



Huwel Life Sciences

Fig CAWACH funded Startup Products in market

Launch of 5 Years Impact report - “CATALYSING INNOVATION ENTREPRENEURSHIP AND INCUBATION” <http://www.nstedb.com/Impact-report.pdf>

This 5 year report focuses mainly on the journey of the NSTEDB in catalyzing innovation, entrepreneurship and incubation was launched by Secretary Department of Science and Technology, Professor Ashutosh Sharma at an online programme in September, 2020, in the presence of the DST supported incubator community and the NSTEDB Team



Impact report was collaboratively prepared by Team NSTEDB, DST, and Syndicate Bank Entrepreneurship and Training Centre, Indian Institute of Technology, Kanpur, in association with the assigned third-party Indian Science and Technology Entrepreneurs Parks And Business Incubation Association (ISBA) and its vast network of Incubator members. The learning from the last few years will help NSTEDB, DST to re-engineer the offerings and carve out new initiatives that will go along way to achieve Atma Nirbhar Bharat Mission.

i-STED (Innovation, Science and Technology led Entrepreneurship Development) Programme

i-STED programme is a five-year project, aimed at supporting micro-enterprises in semi

urban or rural people focusing on products targeting domain specific, area relevant validated innovative technologies. Ongoing 14 projects were being supported under this scheme, in the current year.

India International Science Festival - IISF 2020, <https://iisfvirtual.in/>

Union Minister of Science & Technology, Earth Sciences and Health & Family Welfare Dr. Harsh Vardhan inaugurated the curtain raiser of IISF-2020 for kick-starting different events of the 6th edition of IISF, in New Delhi. IISF is an annual event organized jointly among others by DST, DBT, MoEF, MoHWF and CSIR from the Government of India and Vijnana Bharati (VIBHA) as well as with support of a large number of other organisations.

The complete event this year was virtual including the National Startup conclave, where NSTEDB was responsible to invite startups, delegates and speakers. Also was the core organisers of National Startup Conclave 2020. Many startups of CAWACH program and NIDHI-TBI incubatees were recognised at National Startup Conclave.

NSTEDB NIDHI Impact Journey Film

https://www.youtube.com/watch?v=vpRikXByAuE&feature=emb_logo

NSTEDB prepared a documentary on the journey and impact of the NIDHI program. This film was released at Startup India International Summit, organised by Department for Promotion of Industry and Internal Trade (DPIIT), Ministry of Commerce and Industry during 15th and 16th January 2021 to mark five years of Startup India National Initiative. Hon. Prime Minister Narendra Modi was the Chief Guest of this Summit PRARAMBH.

NSTEDB is committed to harnessing the power of collaboration with industry and stakeholders for realizing the vision of Atma Nirbhar India and a new resurgent India.

3.5 National Council for Science & Technology Communication

Public awareness of science as well as promotion of scientific temper amongst masses are two major objectives of Indian science communication programme spearheaded by the NCSTC, DST. Highlights of various activities and achievements are summarized here under different areas

3.5.1 Content Development

Science Channel:

The Science TV Channel started with two innovative platforms, DD Science – a one-hour slot on DD National, in collaboration with Doordarshan, and India Science – a 24x7 OTT Internet-based channel, which were launched on January 15, 2019 by Dr Harsh Vardhan, Hon'ble Minister (S&T, and ES). DD-Science was continued till 31 March 2020. The project

is now focussed on India Science platform producing video content – documentaries, studio-based interviews and talk shows, outdoor shows, especially conceived programmes, science magazine, R&D features, innovation features, short films, bulletins etc. and maintaining a steady supply of relevant programmes for India Science platform, including LIVE streaming of important events and video on demand. During 15 January 2019 to 30 November 2020, a total of 1765 programmes were produced, 712 programmes (365 hrs) were Telecast, with a reach around 9.5 million. It is expected to hit 200 million in the next few months and various platforms like My Gov and other social media platforms are being leveraged. India Science is accessible on the notable platforms -India Science App: Android / iOS App (download from Google play store /Apple store), India Science YouTube: www.youtube.com/c/indiascience, India Science, India Science Website www.indiascience.in, Facebook: <https://www.facebook.com/indiasciencetv>, India Science Twitter: @indiascience, India Science Instagram: [indiasciencetv](https://www.instagram.com/indiasciencetv), India Science LinkedIn: India Science, India Science Pinterest, Jio TV, Jio STB, JioTV+, JioChat.

Development of S&T Content on Wikipedia in Indian Languages:

Development of S&T Content on Wikipedia in Indian Languages a new initiative which supports the government's Digital India and Information for All in Indian languages. Formal discussions of group of experts have been conducted and an official expert committee has been constituted based on their commendations drawing diverse expertise including science and technology, encyclopedia, quality control, education, data science, media, and intellectual property rights, etc. Under the guidance of expert committee proposals from IIT Hyderabad, IIT Kanpur and CDAC- Noida have been recommended in-principle for DST support.

3.5.2 Professional Development

Augmenting Writing Skills for Articulating Research (AWSAR):

First national competition for 'popular science story' submission was organized under AWSAR, a unique initiative of Department of Science and Technology (DST) that aims to connect existing gap in communicating research to common person by utilizing the latent potential of PhD Scholars and Post-Doctoral Fellows (PDFs). DST had received overwhelming response under this novel endeavor of science communication.



A book of AWSAR awarded articles encompassing 124 popular science stories under both PhD and PDF category was released by Secretary, DST, during the interaction meeting with Science Correspondents on 12 September 2019. Six workshops were organized at Chennai, Gandhinagar, Kolkata, Guhawati, Delhi and Lucknow to guide scholars about "How to write a popular science article". More than 600 scholars attended these workshops

Research & Training workshops in Science Communication:

Workshops for children upto high school level & science communicators have been supported on role plays & gamification and joy of science learning for strengthening science messages of Mobile Science Labs, virtual exhibitions at N. Delhi & Puducherry covering a total of 1350-900 children through 450 teachers/communicators and offering capacity built and science media to NGOs, schools, science communicators, etc. through creative development & field trial of Role plays/Gamification & Simulation of physical processes, etc. Training Workshop to Facilitate Eco Intelligent Youth Driving the Change at Eco Tourism Destination of Matheran have been supported to develop Young Community Advisers from remote tribal area of the Eco sensitive zone of Matheran. Young Change makers (YCM) of the Earth have been supported as saviours for native marginalized population of Kachchh towards adaptation to climate change vagaries. YCMs were also assigned small field projects of 15 days. Young change makers in the less endowed mountainous districts of Chamba and Sirmour, Himachal Pradesh have been trained with preparation of various S&T Communication training modules.

National Awards for S&T Communication and Popularization

NCSTC instituted National awards in 1987 to stimulate, encourage and recognize outstanding efforts in the area of science popularization and communication. Presently, there are six awards to be given on National Science Day, Feb 28, 2021 as follows:

- National Award for Outstanding Efforts in Science & Technology Communication in General
- National Award for Outstanding Efforts in Science & Technology Communication through Print Media including Books and Magazines
- National Award for Outstanding Efforts in Science & Technology Popularization among Children
- National Award for Outstanding Efforts in Translation of Popular Science & Technology Literature in Languages Mentioned in the Eighth Schedule of Constitution of India and in English
- National Award for Outstanding Efforts in Science & Technology Communication through Innovative and Traditional Methods
- National Award for Outstanding Efforts in Science & Technology Communication in the Electronic Media

3.5.3 Hands -On Science Programme

National Children Science Congress 2020:

Started in 1993 by National Council of Science and Technology Communication (NCSTC),

NCSC encourages a child scientist of the age group of 10-17 years to identify some societal problems and motivate to arrive at a possible solution through his research-based solutions. NCSC covers almost all the districts of the country with a participation of over 500,000 students. Emphasis is on hands-on science and presentation of the results and its analysis. Some teams also presented working prototype and models. Through a process of evaluation, best of promising ideas and projects were shortlisted for presentation at State level. The current edition of National Children's Science Congress is being convened with a theme of "Science for Sustainable Living". Children's Science Congress is being held online all over the country.

Initiative in Research & Innovation in STEM (IRIS)

The 'Initiative for Research & Innovation in STEM (IRIS)' is a research based science initiative for students, with an objective to inspire promising young scientists in India. It is a public – private partnership of Department of Science & Technology (DST), and Broadcom for empowering the next generation of innovators. To provide the opportunity to maximum participants and students from all over the country and to increase the outreach, IRIS is now aligned with the following National and State fairs to increase science popularization in the country. IRIS 2020 is being held online.

Low Cost Teaching Aids

Training workshops were supported for teachers training in different states with low cost teaching aids to help the teachers in making teaching interesting with an aim to motivate science teachers to perform hands on activities that would enable them to grasp the basic principles of science easily. The participating teachers encourage students and promote the concept of learning science by fun. The programme created a groups of resource trained teachers and evolved an experiment based methodology in the teaching of science.



3.5.4 Promotion of Scientific Literacy

Celebration of the National Science Day (NSD)

The NSD is celebrated every year on 28 February to commemorate the discovery of the 'Raman Effect.' The Government of India designated 28 February as National Science Day (NSD) in 1986. On this day, Sir C.V. Raman announced the discovery of the 'Raman Effect' for which he was awarded the Nobel Prize in 1930. On this occasion, theme-based science communication activities are carried out all over the country. The theme of NSD-2020 was '**Women in Science.**'

The NSD-2020 was celebrated in Vigyan Bhawan on Feb 28, 2020 with the Hon'ble President of India Shri Ram Nath Kovind presenting several awards for science communication and popularization as well as for women scientists in presence of Dr. Harsh Vardhan, Minister of Science & Technology, Health and Family Welfare and Earth Sciences. The occasion included a lecture from eminent scientist Prof Gagandeep Kang, Director of the Translational Health Science and Technology Institute (THSTI), Faridabad, who is the first woman FRS of India to talk on the theme of the NSD-2020.



Fig. Hon'ble President of India with other dignitaries and awardees on the National Science Day Celebration at Vigyan Bhawan on 28th February 2020

National Mathematics Day (NMD)

These activities are organized nationwide through State S&T Councils. Celebration of National Science Day began or culminated on 28 February. Similarly, the National Mathematics Day programme was supported all over the country through State S&T Councils involving colleges and schools students. Celebrations culminated on 22 December to commemorate the birthday of Srinivasa Ramanujan, the great mathematician with a focus on popularizing Mathematics.



Fig. Sh Om Prakash Sakhlecha, Hon'ble Minister of Science & Technology, Govt of Madhya Pradesh releasing information brochure for National Mathematics Day Celebrations in the state

STEMM India:

'Science, Technology, Engineering, Mathematics and Medicine (STEMM) India' activities comprise of Science fairs, melas, expositions, mobile science exhibitions, lecture-demonstrations, interactive media, visits to S&T establishments like labs and industry, hands-on-STEMM activities, and so on. These events, whether stationary or mobile, including mobile science exhibitions, serve to utilize the expertise of resource persons trained/being trained by NCSTC in various aspects of the concerned activities. More than 34 static and mobile exhibitions were organized in different parts of the country.



Perfect Health Mela:

The 27th Perfect Health Mela (Digital Edition) was held from 1st November – 8th November 2020. The Mela was digital this year and the theme was "Safeguarding Ourselves from Covid-19". It was broadcast live on www.perfecthealthmela.com and covers all aspects of health, addressing all segments of society using the medium of low-cost replicable education modules like exhibitions, competitions, infotainment and free health check-ups under one roof. NCSTC participated in this event for science popularization & outreach activities for students & general public and organized exhibition with science activity corners. 101 organizations took part including the Central & State Govt. Depts, agencies, Corporate, Schools, Colleges, Health & educational institutions. School Competitions were held with 1121 children representing 60 Schools from Delhi NCR participated in various competitions on days 1 and 2 of the mela. All students participated in these competitions using virtual platforms from their homes. The competitions held were Yoga (Solo), Kavita Path, Singing (Solo), Painting, Mono Act, Slogan writing, and Science Model. 6 webinars were held during the mela days. A total of 30707 Students, teachers, Principals and general public from zoom platform/YouTube/Facebook viewed these webinars. Science Activity Corners facilitated 88 online science activity sessions for school children and general public. These science activities were seen by 2606 people on Zoom and 177424 visitors on YouTube & Facebook. 32 digital stalls were set up and in which exhibitions about the activities /schemes etc were put up by Dept. of Science & Technology, Govt. of India along with partner agencies. 30792

visitors have visited the PHM website till 8th November 2020. Two virtual press conferences were held during the period between 26th October 2020 and 2nd November 2020. The first digital mela was widely covered in digital medium (YouTube, Facebook, Instagram, Twitter). The outreach crossed 1.5 million+ on Social Media. 705.8K+ views on facebook, 582.2k + views on YouTube, 7.5 Million+ reach on YouTube, 12500+ impressions on Twitter, 199.6K+ Reach on Instagram. 9 print and 22 online media covered the mela.

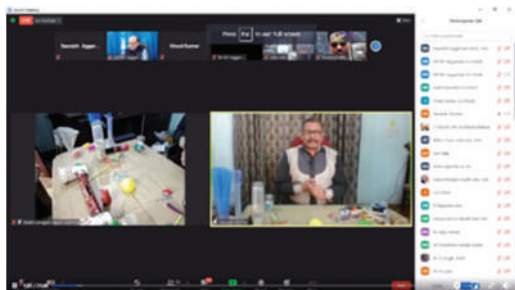

Science Exhibitions on Wheels:

Through ‘Mobile Science Exhibition/Mobile Science Lab & Exploratory’ students, especially having no or very little access to lab facilities, get an opportunity right at their school premises for hands-on engagement in science activities which will help them in understanding difficult curriculum-based concepts with fun and ease. The target group for these activities includes general public, school & college students, youths, women, teachers, gram panchayat members, voluntary organizations and policy makers, etc. Several such Mobile Science Exhibitions/Labs run in different states. “Circus of science” or Vigyan ka Jantar Mantar ran in the districts of Kurukshetra and Nuh (Mewat) from December 1, 2018 to Nov. 30, 2020, covering 14,450 Kms., visiting 206 Villages – schools and the community at large, and benefiting 47,000 individuals. More than 47,000 people including students, teachers, and general public came in contact with the Mobile Science Laboratory through school visits, evening community programs, science exhibitions in schools, cultural fairs (state-level and international level) and online engagement by conducting various competitions, webinars and live telecast of celestial events (annular solar eclipse and a moon-watch). The lab visited 124 Government senior secondary and high schools in Kurukshetra and Nuh (Mewat) districts. 20497 students, belonging to classes VII to XII, were engaged in scientific activities conducted in the lab. The MSL also visited 31 villages in Kurukshetra and Nuh (Mewat) and engaged a population of 2338 through evening community programs to create awareness on general topics and themes involving science and technology by screening science documentaries and showing myth buster experiments.

During the coronavirus pandemic, 2144 students from seventeen states participated in online essay and poster competitions on “Coronavirus Pandemic – Problems & Solutions”. On World Environment Day 2020, 469 students participated in declamation competition and plant-a-tree campaign. The live telecast of Annular Solar Eclipse on June 21, 2020 was

a great success. More than 3700 people of all age groups joined through Facebook and YouTube channels of the Society and interacted with eminent scientists and professors on SPSTI's platform. Many other webinars were conducted for students as well as public on topics of science & technology. The lab visited 22 villages in Kurukshetra and 21 villages in Nuh (Mewat) and engaged more than 4000 village people during the coronavirus pandemic.

The 'Joy of Science' Mobile Science Lab & Exploratory (MSL) is operational in Gujarat. As of Dec 2020, it has reached out to 166 schools in various districts of Gujarat, including the two aspirational districts Dahod and Narmada, with direct participation of over 40000 students and over 1700 teachers in the MSL activities.



STEMM Bike:

The motivation behind STEM BIKE (Create Science Awareness through Demonstrations among the rural people) program is to promote Science, Technology Engineering, Math education through development of logic, systematic observation and hands-on experiments to make learning science an enjoyable experience. Seven science communicators travel on Bikes along with one programme coordinator and one co-ordinator to visit different villages in the districts to demonstrate various activities for awareness in remote areas in three Districts of Haryana State namely Kurukshetra, Karnal and Yamunanagar around 52 Schools/Villages. Programme inaugurated and Flag off in Kurukshetra and Yamunanagar districts by the Deputy Commissioner of respective districts.



Science Communication through Folk Media:

Training workshops & awareness programmes were supported to promote S&T awareness in local language in different states and to develop resource persons as science communicators through folk media. *Utpreeran Yatra*, the folk media Campaign for issue based science popularisation in Villages of Dehradun District was organized in local dialects and through

traditional methods to sensitize the society on solid waste management, environment conservation, water quality, popularization of science, evils of superstitions and, foremost, to develop scientific temper in the society. Doiwala and surrounding areas were taken as parts of Yatra.

3.5.5 Risk Communication Programme

Year of Awareness on Science & Health (YASH):

The current scenario of a pandemic has posed concerns and challenges all around where scientific awareness and health preparedness can play a significant role to help combat the situation with translation and usage of authentic scientific information to convey the risks involved and facilitate the communities to overcome the situation. A comprehensive national programme was launched on health and risk communication with focus on COVID-19, namely, Year of Awareness on Science & Health (YASH). A full-fledged programme architecture was developed with scope for content creation and its zonal utilization, along with assessments of outcomes and recycling the lessons learned. YASH information brochure was brought out and has been released by Hon'ble Minister of S&T and ES & HFW. As part of the programme, the NCSTC has brought out an online multimedia resource guide on A-to-Z of COVID 19, titled *COVID Katha – A Multimedia Guide for Mass Awareness*, in Hindi & English. This interactive resource book has been recently unveiled by Hon'ble Minister of Science & Technology and Earth Sciences and Health & Family Welfare on 03rd May 2020, Foundation Day of Department of Science & Technology. The Guide is being translated into Bengali, Odia, Gujarati, Assamese. The messages are going far and wide in preparing the nation in fight against COVID 19.



Fig. Dr Harsh Vardhan, Hon'ble Minister of S&T and ES, Health & Family Welfare releasing 'Covid Katha' on 03 May 2020

The existing campaigns were reoriented in TN, Karnataka, AP, Rajasthan, Uttarakhand, Madhya Pradesh, which also motivated youth to pursue science and work for green economy sectors. "COVID Katha" was actively promoted to bring about freedom from panic and S&T solution seeking behaviour to address the looming threats of the pandemic. P.N. Panicker Foundation launched *Quit Covid* campaign for Tamil Nadu, Karnataka, and Andhra Pradesh on Quit India day, 9th August 2020, which aims at popularization of Eco Literacy, Science

Literacy, Digital Literacy, Environment Literacy, Total Literacy etc. National webinars were organized from 2nd October-the Gandhi Jayanti Day followed competitions - Quiz, Open Art, Essay Writing, Video Books etc.

3.5.6 Cooperation In Science Communication

UNESCO Kalinga Award for Science Popularization (Biennial):

The UNESCO Kalinga Prize for Popularization of Science is a prestigious award given by UNESCO for exceptional skills in presenting the scientific ideas to lay people. It was created in 1951, following a donation from Shri Biju Patnaik, then Chief Minister of Odisha and Founder President of the Kalinga Foundation Trust. Now the Prize is co-funded by DST, Government of India, Kalinga Foundation Trust and DST, Government of Orissa. The recipient receives US\$40,000 and a UNESCO Albert Einstein Silver Medal. The recipient is also awarded the Kalinga Chair, introduced by the Government of India in 2001 to mark the 50th anniversary of the Kalinga Prize. As holder of the Kalinga Chair, the winner visits India for a period of 2-4 weeks as the guest of Government of India. The Chair also comprises a token honorarium of US\$5,000. Dr Karl S. Kruszelnicki, Julius Sumner Miller Fellow, The Science Foundation for Physics, School of Physics, The University of Sydney, Australia is the winner of UNESCO Kalinga Award for Science Popularization for 2019. He shall be bestowed with the Kalinga Chair by Department of Science & Technology, Government of India.

3.6 Science for Equity for Empowerment and Development (SEED) Division

The Department of Science & Technology with its Science for Equity for Empowerment and Development (SEED) division works to connect STI for the empowerment of communities living in remote and rural areas, SC/ST, Divyangjan, elderly and women through Science led solutions and development and deployment of location specific appropriate technologies for creation and improvement of Sustainable Livelihoods and better quality of life. Action oriented Initiatives under SEED division are steps towards contributing to the National initiative for “AatmaNirbhar Bharat” by empowering communities through STI at the local level for socio-economic well-being with environmental considerations and to contribute to UN-SDGs as well.

Specific initiative under SEED division are as under:

Technological Advancement For Rural Area (TARA): Long Term Core Support:

Under TARA scheme of the department, Long Term Core Support was provided to 26 S&T based NGOs to evolve and deliver scalable technological solutions to address location specific challenges at the grassroots level. These groups having strong linkages with R&D labs/ academic institutions for technical backup support besides in-house capabilities - play crucial role in technology scaling, delivery & adoption in respective geographical area with local institutional arrangements to empower local community in utilizing field-tested technologies

and packages (Web Link: www.dsttara.in). Several novel and/or adaptive technologies have been developed & deployed under TARA scheme like village level Incinerator system for disposal of waste materials; innovative solar powered Edu Box for use in night schools for formal education to rural children; & threshing cum de-husking machines with value chain approach for millets and rice among others to benefit and empower artisans & small farmers locally. To upscale initiatives under TARA, technology up-scaling efforts are also being made by SEED, DST for encouraging rural innovation and social entrepreneurship ecosystem through technology accelerator by using TARA platform and other agencies.

3.6.1 Specific Outcomes & Initiatives: Core Groups & Social Innovation

- **Technology Informatics Design Endeavour (TIDE), Bangalore, Karnataka**

In the wake of COVID-19, TIDE, Bangalore has initiated the networking of hundreds of people (Diverse stakeholders viz. buyers, rural women entrepreneurs, micro enterprises) using digital technology to overcome the limitation of movement set in their daily lives. Apart from it, a Vidyut Rakshaka (VR) website developed by TIDE, Bangalore helps the common citizens to understand household electricity consumption, management and guide a plan to save electricity. The organization is working on income augmentation and Livelihood generation through Areca leaf sheath enterprises to reduce farmer distress by augmenting incomes through trading in and producing areca leaf sheath products (for food packaging, serving) in the Shimoga district. TIDE is making efforts to replicate biomass based thermal energy interventions like livelihood stoves for sweet making shops, hotels, local brew-making, and biomass dryers for turmeric, cardamom and black-pepper processing. Organization has developed Agni Sakhi (version 2 & 3), Agni Mithra (version 2), Bakery oven, Large onsite stove for sweet makers, accessories and components for PYRO stoves. This deployment will reduce firewood consumption by 70% as compared to traditional system with less carbon footprint.

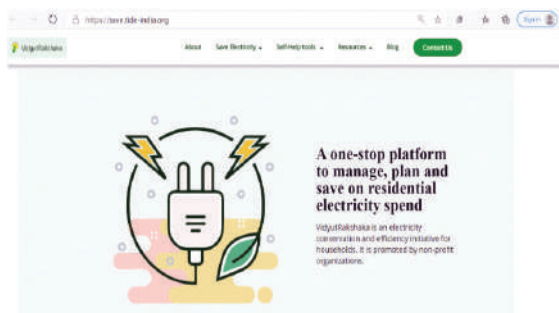

Fig. Women Entrepreneur working on Areca leaf plate making machine



Fig. Vidyut Rakshaka (VR) website developed by TIDE, Bangalore

- **Sardar Patel Renewable Energy Research Institute (SPRERI), Gujarat**

SPRERI, Gujarat has designed 5.75 kWth capacity enamel coated forced-draft biomass

cookstove primarily for continuous feeding of the fuel during the operation. Thermal efficiency of the developed cookstove during testing was found 39% with emission levels under the BIS limits. A total of 500 hrs of in-house testing was done to test for its coating shelf-life and performance. SPRERI has installed a Dhabha size improved biomass cookstoves (IBCS) at Nasta center owned and managed by a SHG group at Zand hanuman, Chotta Udepur with the help of NRLM, Chhota Udepur. Dhabha-size cookstove is in use by the SHG members for making Nashta/food, at Nashta Center (save ~45% wood over their conventional stoves) on rotational basis and the proceeds from the sale on weekly basis is equally distributed among the SHG members. Based on the performance of cookstove, NRLM have raised requirement of another 5 Dhabha-size Cook Stoves for other Dhabhas and/or Government run canteens.



Fig. Enamel coated forced-draft improved biomass cookstove developed by SPRERI, Gujarat

Development Alternatives (DA), New Delhi

DA, New Delhi has developed innovative technologies such as Kota Stone waste based calcined clay cement; Agri-waste based building material products; Marble Sludge waste based calcined clay cement; Limestone Calcined Clay based concrete products; Paver blocks production utilizing foundry waste; Mineral additive based Community Filter (Aeon); Refillable water container (acquired from Solar sack); Hands-free sanitation system. The organization is working on TARA Energy and Resource Management System (TERMS) technology, which is used for the Analysis of Baseline survey of priorities and potential customer for load management. There are 147 active and 60 inactive customers of this technology. Under the initiatives of dissemination of foundry slag waste utilization, 3 enterprises have been created and supported by on-site technology demonstration, training to entrepreneurs, supervisors and workers. A total of 21 workers have also been trained for easy operation of the technology. In response to COVID-19, DA distributed hygiene kits, sanitizers and masks to 8700 individuals; 19000 individuals were provided meals and rations; 49300 masks were produced by entrepreneurs during the lockdown to help communities; 135+ individuals like community leaders, panchayat leaders, construction workers, migrant workers from 5 districts of U.P., Delhi, Haryana and M.P. were trained in prevention measures against the spread of COVID 19.



Hands free and Automatic sanitation system developed by DA, New Delhi



Foundry waste-based paver blocks technology by DA, New Delhi



- A project on **“Improving women & child health in Rural/Tribal India using novel diagnostic technologies for Toxoplasmosis, Rubella, Cytomegalovirus and Herpes simplex (TORCH) infections during pregnancy & maternal stress”** is being implemented by Indian Institute of Public Health (IIPH), Gandhinagar in two blocks Modasa and Bhiloda in Aravalli district of Gujarat. Project intervention has led to setting up of a laboratory for diagnosis and community awareness about infections causing pre-term births and congenital malformations and optimized nested PCR methods for sensitive and specific detection of the TORCH infections amongst pregnant women.
- A consultation workshop on **TAP-RISE (Technology Acceleration Platform for Rural Innovation and Social Entrepreneurship)** involving Core Support Groups (SEED, DST) and stake holders was held in Pune on 25th July 2019 to discuss challenges & opportunities to accelerate impact of technologies through ecosystem building by involving Core Groups for benefits of Rural Communities.
- A capacity augmentation workshop was also organized during 20-22nd January 2020 at IIT, Bombay to build the capacities of Core Groups, SEED, DST to promote knowledge and innovations for improving productivity & livelihoods in rural production system(s) through technology up-scaling for wider social impact at the grassroots level. During this, a special session was conducted on smart village concept to develop an action-oriented program for technology led empowerment and livelihoods enhancement through strategic actions involving Ministry of Rural Development; IRMA, Anand; IIT, Bombay & other stakeholders to orient Core Support Groups and other developmental agencies for addressing upcoming challenges for rural transformation aligning with SDGs and national priorities.
- **A Compendium** of technologies has been brought out comprising 64 field tested technologies related to farm & non-farm sectors and 18 success stories for technology absorption at community level with the efforts of Core support groups to empower

communities through scalable technologies for rural transformation. Detailed technologies may be seen on http://dsttara.in/InnerPages/Technology_Compendum_2019.aspx

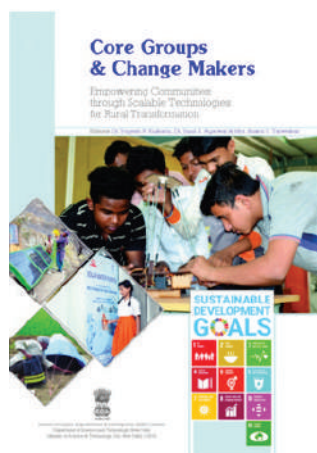

Technology reaching the Unreached: Participation of Core Groups in IISF, 2019 at Kolkata and release of Compendium on Affordable & Scalable Technologies from Core Groups by Dr. Harsh Vardhan, Hon'ble Minister of S&T, Earth Science & H & FW. Prof. Ashutosh Sharma, Secretary, DST interacting in Tech Expo about Improved Ropeway model developed by STD, Mandi for Mountain areas.

Technology Intervention for Mountain Ecosystem-Livelihood Enhancement through Action, Research & Networking (TIME-LEARN Program)

TIME-LEARN as a network program has developed an innovative mechanism for sustainable development in the mountain regions involving science and technology-based field groups, voluntary organizations, knowledge institutions and mountain community as well. Under this program, total 20 projects are being implemented by various organizations and scientific institutions in the three states viz. Uttarakhand (8), Himachal Pradesh (8) and Jammu and Kashmir (4).

A project to introduce Bee-Keeping Mud Hive Technology in Wet Temperate Zone of H.P was completed by **Society for Technology & Development, Mandi, HP**. This project has

led to promote and conserve the indigenous honeybee i.e. *Apis cerana*--introduced about 80 colonies of local bees through Mud Hives Technology to increase local bee population in the project area. The project has covered 45 farmers and about 50 hectare of land having apple plantations to study the impact of mud hives on fruit production. Project intervention with improved pollination has increased the apple productivity about 20 percent in apple orchard. Besides, production of about 500 kg of honey was reported with scientific processing in one year from 100 colonies leading to 30% increases in income of the farmers in that area as additional income.

- An interactive group discussion for Technology up scaling and delivery during review of TIME-LEARN program was conducted at Wildlife Institute of India (WII), Dehradun during 26-27 Dec, 2019 involving S&T led NGOs and Institutions from UK, J&K and HP states to deliver affordable & scalable technologies for addressing livelihoods and conservation challenges involving mountain communities in the North-West Himalayas.

Case study 1. Innovative Skills for Mountain Artisan for Clean Energy Solutions and improving living in mountains by HRG, Shimla, H.P.

TIME-LEARN program is setting a new agenda to strengthen institutional framework for mountain development in North Western Indian Himalayas. HRG Shimla has implemented innovative approach to provide clean and cost-effective solutions of solar water and space heating in remote and difficult areas of mountain households in Himachal Pradesh and Ladakh.



Fig. Sh. Bodh Raj and Sh Om Prakash working in fabrication activity for Solar based heating panel at Padum, Zaskar valley, Ladakh

Rural artisan's new Skills and Enterprise

HRG's new innovations of mountain solar water and space heating systems provided new skills and confidence to the group of artisans at village Dhangiar in Gohar Block of District Mandi in designing, fabrication and installation of innovative mountain solar water and space heating systems under the guidance of HRG team. 88 system under SEED-DST-TIME-LEARN in HP and 159 systems in Zaskar valley, Ladakh have been installed.



Fig. Artisans working in fabrication activity at Dhangiar Mandi H.P.

Case Study 2. Mainstreaming Farmers Varieties in Himachal Pradesh and Uttarakhand by ICAR- National Bureau of Plant Genetic Resources, Regional Station, Phagli, Shimla (HP)

The *on-farm* conservation and mainstreaming of traditional crop landraces are becoming extinct due to change in climate and onslaught of cash crops. Diverse rich areas of Himachal Pradesh and Uttarakhand were surveyed filling structured questionnaires to know the cropping patterns adopted by the farmers. During the survey, 571 traditional landraces of paddy, maize, french bean, finger millet, barnyard millet, wheat, barley, mustard and lentil, which are still under cultivation were collected from threshing yards, farmer's store and farmer's field. Further to characterize, evaluate and multiply these landraces, for which 554 pilot farmers with better skills were identified and seed of traditional crops were distributed among farmers. To educate them with the significance of traditional landraces, various awareness programs, interactive meets and focus group discussions were organized in Berthin of Bilaspur, Haribena and Dhangyra of Mandi in Himachal Pradesh and Suri in Almora, Malari in Chamoli, Malonj in Someshwar and Doni in Tehri of Uttarakhand. Promising landraces of traditional crops were sent to PPV&FRA, New Delhi for their registration. To strengthen the community level informal seed system, two Community Seed Banks (CSB's) have been established in Dhangyra (Mandi) and Polling (Kangra) villages and are linked to Gram Panchayats and local bodies for maintenance and supply. In this endeavor, a community group named Gramin Khadya Samprabhuta Samooha (Peasants Association for Indigenous Food Sovereignty Campaign), farming community GKSS (cluster of seven village panchayats in Tarikhet block district Almora, Uttarakhand) and NGO partner "Jai Nanda Welfare Society" in Chamoli district Uttarakhand have been facilitated with Plant Genome Saviour Community Award conferred by the PPV & FRA, New Delhi.

Case study 3. Water Harvesting in Rainfed Areas: A Success Story of Sh. Darshan Lal Demonstration of Technologies for Improving Productivity of Rainfed Area in Jammu District by SKUAST, Jammu

Under TIME-LEARN program, promotion of soil and water conservation technologies for improving the livelihood has been carried out by SKUAST-Jammu with twin objectives viz. creation of water harvesting and recharging structures and efficient utilization of harvested water for improving livelihood in Shivalik region. In addition to soil and water conservation structures/systems (Poly tank, percolation tank, recharging pit, earthen embankment, gabion structures, bench terracing, contour bunding, continuous trenching, roof water harvesting and micro irrigation system) the other activities like promotion of scientific cultivation of maize and wheat crop through recommended maize seed (Kanchan-517, Gold) and wheat seed (WH-1080) were promoted among the farming community. A tool kit comprising tubular maize sheller, serrated sickle, line marker & gudnoo was developed to benefit the farmer for improving productivity, efficiency and reduction in drudgery. Due to these technical interventions under the project, the average productivity of maize and wheat has been reported to increase

by 25-30% and 30-40% respectively. Accordingly, Darshan Lal has earned net profit of Rs. 25,600/- in a year through sale of vegetable seedlings and vegetables.



Scheme for Young Scientist and Technologists (SYST)

The Department of Science and Technology (DST) initiated Scheme for Young Scientists and Technologists (SYST) in the year 1991, to harness the potential of young scientists and technologists towards socio-economic development of the country by providing technology-based/led solutions for societal challenges. The scheme has been revamped in 2019 to use knowledge and fresh perspective of young researchers in new and upcoming technological areas such as Artificial Intelligence and IoT for Societal Application, Scientific Validation and Upscaling of Traditional Knowledge Systems, Effective Indigenous Methods of Disease Identifications and Monitoring etc. A total of 52 new projects were supported in the year 2020- 21.

Significant achievements of the projects funded under SYST:

- A low-cost energy efficient system to monitor and report vital water quality parameters for high density aquaculture farms in real-time through internet/mobile was developed at National Institute of Technology (NIT), Puducherry for the benefit of farmers. The device monitors the parameters such as salinity, temperature, pH, dissolved oxygen, etc. through virtual sensing thus augments the use of resources, improves sustainability and profitability to farmers. The use of developed monitoring system creates less stress on water resources and would also prevent water source contamination. A machine learning based water quality prediction system was also implemented based on the data collected from Agency for Development of Aquaculture Kerala (ADAK) under Government of Kerala.

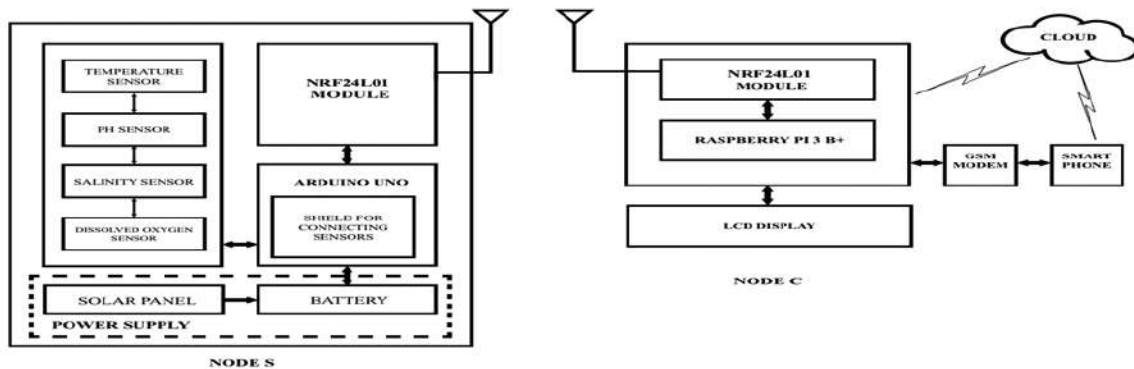
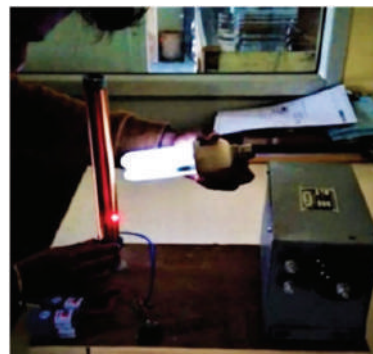
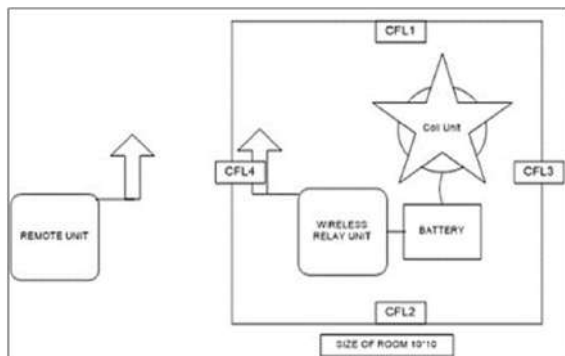

Fig. Water Quality Monitoring System Architecture and Device

- A portable, wireless light system using fused fluorescent bulb/LED was developed at University of Petroleum Energy Studies (UPES), Dehradun for remote villages in hilly areas. The system comprises of a fused bulb and a transmitter that acts as a hub to create electromagnetic field without any direct contact with a power source and act as wireless power distribution area network. A solar panel is attached at the base of the hub and is charged with sunlight. The 4 hours solar charging of the hub provides a multidirectional spreading of power thus glowing 32 bulbs of 8 watts simultaneously for 4 hours. The system also contributes towards waste management and rural electrification.



Portable, wireless light system for rural India

- A low-cost plant based synergistic natural supplement to alleviate gouty arthritic conditions has been developed at CSIR-National Botanical Research Institute (NBRI). Extensive screening of 36 potential medicinal plants through *in-vitro* models resulted in 8 potential leads. The *in-vivo* efficacy and safety of identified leads was established and found at par with standard drug colchicine based on the results of *in-vivo* models. The prospective synergistic combination, upon safety and efficacy studies revealed anti-gout activity in animal models exhibiting significant improvement in locomotion, inflammation, joint edema, stiffness, redness and other associated symptoms. The developed natural supplement aims to improve the lifestyle of aged, elderly and compromised section of society by restoring their locomotion. The technology transfer process under AYUSH mode has been initiated.

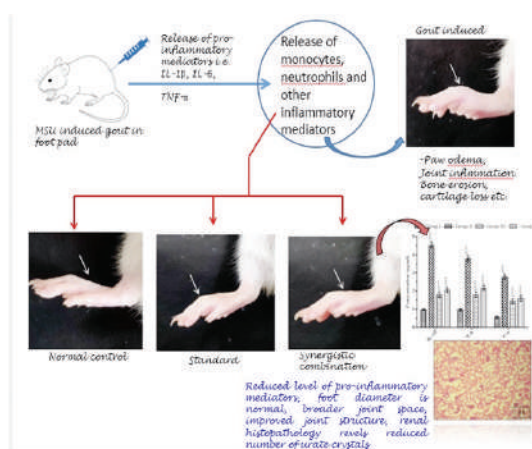

Technological Interventions for Addressing Societal Needs (TIASN)

The TIASN programme involves technology development and adaptive R&D for the benefit of society. The socially relevant projects from R&D Institutions, Universities, and NGOs in Agriculture, Health, Nutrition and activities related to Non-Farm sector are supported under this programme. During current financial year, DST has supported 4 projects.

Significant achievements of the projects funded under TIASN:

- A low cost, portable laboratory workbench was developed by Chandigarh University for providing science education to school children in rural areas where schools have several constraints with respect to space and money for setting up a science lab. This workbench will inculcate creative and critical thinking among school going children and also address the distress faced by the rural students while joining graduation courses in science, engineering and medicine. The bench has the capability of computing and programming for realizing various theoretical concepts related to different subjects (like physics, chemistry, biology, mathematics, general computing, electronics, etc.) as per the NCERT curriculum. Total 47 experiments recommended in NCERT textbooks and emerging domains i.e., Artificial Intelligence (AI), Simulation (Programming, Robotics, PCM) are inbuilt in this workbench for the benefit of students. During the COVID 19, a portable sanitizer bench was developed by tweaking the objectives to address the necessity in rural setting.



- Burnt clay brick play important role in rural economy of Bihar with 6364 registered brick kilns producing 19 billion red bricks/annum. The key fuel used for red brick production is coal and about 4 million tonnes of coal/annum is being used to produce bricks in Bihar leading to generation 12 million tonnes of CO₂/year. The cost of brick is closely associated to the price of coal which is increasing day by day. In order to address the environmental and energy concerns related to red brick kiln production a project supported under TIASN, was implemented by Technology and Action for Rural Advancement (TARA), DA to develop and demonstrate **internal fuel based red brick production** process in Bhagalpur, Bihar. The pilot trial conducted in a natural draught zigzag kiln by mixing of 2% coal waste with soil prior to fabrication of the green brick reduced consumption of external fuel. This also resulted in energy savings and reduction of emissions. The process led to 9% increase in energy efficiency, reduction in cost of external fuel by 30%, reduction in air pollution load by 10% (CO, CO₂, NO_x & SO_x), improved compressive strength of fired brick by 12% and reduced cost of production due to lower rejection rate of fired bricks. The profit got doubled due to reduced cost of production and higher selling price for improved quality of fired brick.

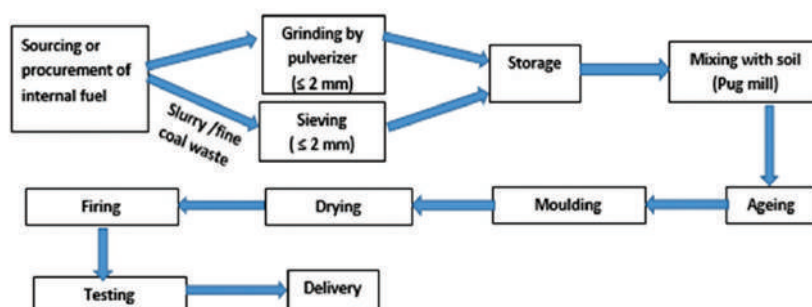

Fig. Schematics of brick making process using internal fuel technology by TARA, DA

Response to COVID 19:

The year 2020 has seen unprecedented COVID-19 outbreak. The SEED Division of DST issued an advisory to supported Knowledge Organizations to create scientific awareness on COVID-19 using social, print and electronic media to develop resilience at community

level and showcase their Science and Technology (S&T) based interventions to address the challenges related to containment of disease and economic restoration as part of their Scientific Social Responsibility (SSR). Our Scientists supported under DST funded project at CSIR-NBRI, ICAR, Chandigarh University, Manipur University, SKAUST-Srinagar, Baba Farid University of Health Sciences-Faridkot, Punjab etc against several odds came forward for the cause. These institutes voluntarily contributed their knowledge and resources for the development and distribution of sanitizer as per World Health Organization (WHO) guidelines, mask preparation as per the guidelines issued by Principal Scientific Advisor (PSA), Government of India and services for COVID 19 testing.

A mobile App based regular advisory to pregnant women was initiated under already ongoing projects at AIIMS New Delhi. SKAUST, Srinagar initiated a telemedicine facility for monitoring the health of farm animals under ongoing projects. In order to address breathing related issue an herbal decongestion spray on the principles of Ayurveda was developed. More than 5000L of sanitizer was distributed among migrant population, AIIMS-New Delhi, Safdurjung-New Delhi, Police Department of Haryana & Punjab and UP. The technology of herbal sanitizer developed under the DST funded ongoing project was transferred to companies for bulk production and sustaining the supply for public consumptions at affordable rate and the protocol was also shared with Voluntary Organizations for distribution at local level.

3.6.2 Science & Technology For Women

Sustainable Public health & Primary Health Care in Resource poor Settings involving Women with Innovative Technology -Foundation for Innovations in Health, Kolkata under a project supported by the department, gave training to eight women as front-line health workers as per National Skill Qualifications Framework. The women have been trained in a 6 months' Frontline Health Worker course in collaboration with "School for Skills: Allied Health Sciences". Organization has also developed 'Uday' a static medical algorithm-based software ecosystem with android based front-end and Microsoft SQL (Structured Query Language) server based back-end (EHR system). The "Uday" centres work toward increasing access to primary health care in an E-Health ecosystem with a combination of low-cost diagnostic tests and doctors' consultation. Uday also works toward creating awareness about public health through community engagement programme in schools.



Patient consultation Uday, Barhra (Birbhum), West Bengal



Information dissemination to school going children Uday, Barhra (Birbhum),

Empowerment of Rural Women through Science and Technology based Skill Development

PUSHPA GUJRAL SCIENCE CITY, Kapurthala in collaboration with SEED Division, Department of Science & Technology, GoI has started an initiative to empower rural women of nearby villages. The project aims at ensuring that the benefits of science and technology percolate to rural women and provide them skill training and incubation facility to earn their own livelihood in a dignified manner. So far following trainings have been organized:

***Pleurotussajorcaju* Cultivation:** The infrastructure w.r.t the training was set up. The training program has been aligned to NSQF. So far three short term trainings have been organised to train more than 50 women. The initiative further collaborated with the Department of Rural Development and Panchayats and trained women (Krishi Sakhis) identified by them at Science City. These Krishi Sakhis are expected to further train women farmers across Punjab.



Fig. Three short duration trainings were organised on preparation of Cow Dung Logs & Pots. 52 women were trained in innovative ways of making these products on machines.



Fig. Endorsing Employment Confidence of Women through Appropriate Coir Cluster Merchandises Training Development for their Life Uplifting in Rural Environment

Hindustan Institute of Technology in Kappalankarai Village, Coimbatore under a project supported by the department has designed a machine for improving the existing design for coir processing units, in terms of strength of the husk, reduction in soaking time of the fibre, etc. More than 100 rural women were trained in three training programmes of fifteen days each on extracting coir from the coconut shell by the help of designed machine tool, processing of the coir into products like doormat, coir bricks, coir-based flower pots and minor repairs of the machinery. The women have been introduced to Market strategies and skill development knowledge.



Fig. Women rectifying machine fault during the training session

Rural Women Technology Park at KVK-Ii, Sitapur (U.P.)

A Rural Women Technology Park is being supported at the Krishi Vigyan Kendra, Sitapur, U.P. Under the project 100 women will be trained per year from nearby villages per year. Two awareness programmes were organised to sensitize nearly 1000 women on livelihood opportunities. RWTP is working on:

- **Component 1:** Drudgery & occupational hazards reduction of rural women through improved farm tools and implements
- **Component 2:** Utilization of farm waste/ by-products for production of fuel through Portable Charring Kiln & Briquetting Machine and its uses in improved smokeless cooking stoves
- **Component 3:** Agriculture Based Enterprise Development: Azolla Cultivation and Makhana Processing, Ornamental fish culture and Backyard Poultry

Promoting Spice & Pulse crop Cultivation for self-reliance of rural women in Sirmour district of Himachal Pradesh

Social Awareness Through Human Involvement (SATHI), Sirmour is implementing an ongoing project in 15 remote villages of Ghinni-Ghad region of Pachhad development block of Sirmour district in Himachal Pradesh on promoting spice & pulse crop cultivation. Till date, 190 women have been trained in improved cultivation practices. So far, nine such training camps have been organized. After analysis of soil, data at Dr. YS Parmar UHF, Nauni, Solan (HP) villagers were given technical suggestions to improve soil nutrient and productivity of pulse-spice crops. Seeds of improved variety of *Ginger, Turmeric, Coriander, Maithi, Garlic, Onion* (Spices) and *Udad, Kulthi, Gram & Masri* (Pulses) were distributed to the farmers, as per their requirement. Due to these interventions, women farmers are able to fetch **extra income** through sale of pulse-spice crops & related value-added products. Not only this women farmeris also encouraged self-consumption of pulse produced due to this **general health status** of target women has improved.



To store quality seeds for upcoming season, **Seed Bank** has been initiated for Ginger, Turmeric & Gram. So far 15 SHGs have been formed, which have given a common platform for **regular saving, inter-loaning facility and profit sharing.**

TECHNOLOGY INTERVENTIONS FOR DISABLED AND ELDERLY

The Technology Interventions for Disabled and Elderly (TIDE) programme promotes Research and Development in the field of Assistive Technology for developing tools, technologies, techniques and protocols for creating inclusiveness and universal accessibility for Divyangjan and Elderly in different built environments, mobility, information and communication systems. The significant achievements along with the details of some of the ready to commercialize assistive technologies developed under the Programme during the year 2020-2021 are given below.

The web portal *oldagesolutions.org* for older persons supported under the TIDE Programme and maintained by Department of Geriatric Medicine of All India Institute of Medical Sciences, New Delhi has been relaunched to provide holistic information to ensure physical, mental and social wellbeing of senior citizens. The web portal includes information related to health, nutrition, housing, design, environment, recreation, entertainment, networking, and assistive devices to enhance the quality of life among older generation. The web portal currently has approximately 5.5 Lakh viewership including recurrent visitors



Fig. webportal of Old Age Solutions

An **Artificial Intelligence based Fully Automatic Assistive Technology** is designed and developed under a project supported to Dr. APJ Abdul Kalam Technical University, Lucknow.

The device can perform scene segmentation and provide auditory inputs about the surrounding in real time to Visually Challenged. Artificial Intelligence based deep learning-based method is used to train a model that has images of objects, which are of high relevance to the visually impaired. The trained model can be ported to any low-cost computing device for real time identification of the objects. The use of the deep learning model makes this assistive technology highly accurate, robust to ambience lighting conditions, different viewing angles and work in real time.

In addition to computer vision-based techniques for object recognition a distance measuring sensor is also integrated to make the device more comprehensive. The auditory information that is conveyed to the user after the scene segmentation and identification is optimized to get the more information in less interval of time and faster processing of the video frames. The prototype device is under extensive field trials.



Fig. Artificial Intelligence based Fully Automatic Assistive Device

Various assistive technologies for creating resilience among Divyangjan and Elderly were also developed during the COVID-19 Pandemic. An e-Tool to create awareness and impart health and hygiene related information along with education and entertainment to overcome loneliness of the persons with intellectual disabilities due to COVID-19 pandemic have been developed. The Beta Version of the e-tool is used by 200 specially-abled children. A wearable sensor device is developed to remotely monitor the activities of Elderly and Divyangjan staying alone or who happen to be under quarantine or isolation wards. A wearable rehabilitation band with real time monitoring and feedback of recovery process through guided rehabilitation protocols is developed for elderly with motor function disabilities, that will eliminate the physical presence of physiotherapist. These devices are tailor-made for the current COVID-19 situations.



Fig. Screenshot of Web based E-tool



Fig. Wearable Rehabilitation Band

A two-day Conclave and Expo on “Assistive Technologies and Divyangjan” was held in the India International Science Festival 2020. More than 500 participants comprising of researchers, users, industry, PR actioners, NGO’s and Government deliberated on the unmet needs of Divyangjan and called for innovative approaches to solve the problem. The recommendations will pave for developing more and more technically feasible and economically viable solutions for building a *Self-Reliant Assistive Technology* ecosystem in India.

3.7 Special Component Plan for Schedule Castes (SCSP) & Tribal Area Plan (TSP)

The Science for Equity Empowerment and Development (SEED) Division of the Department of Science and Technology (DST) has been providing grant-in-aid support to several S&T enabled Voluntary Organizations (NGOs) and knowledge institutions (KIs) for a long time for the holistic development of Scheduled Caste (SC) and Scheduled Tribe (ST) communities in India under the SCSP (Development Action Plan for Scheduled Caste – DAPSC and TSP Schemes). The NGOs and KIs had implemented several S & T projects directed towards addressing the basic day-to-day needs of the people that increase the adaptive capacity and resilience to emerging problems of livelihood systems and brought into practice innovative approaches towards creating opportunities for sustainable development through application of S&T. The prime objective of the schemes is to empower the SC & ST Communities through promotion of research, development and adoption, transfer and dissemination of proven technologies to solve the problems of economically weaker Scheduled Caste (SC)/ Scheduled Tribe (ST) communities, especially in rural areas through application of Science and Technology. The Division has also implemented various network programmes involving NGOs and KIs and has set up Science Technology and Innovation Hubs for inclusive development of SC and ST Communities. Significant achievements and details of projects supported during 2020-2021 under these schemes are given below

3.7.1 Scheduled Caste Sub Plan

Several projects in diverse technology areas like agriculture (including fisheries, animal husbandry, horticulture technologies etc.), forestry, alternate livelihoods, post-harvest technologies, natural resource management, health and sanitation, occupational hazards, rural industry and micro enterprise, sustainable agricultural practices etc. were supported during the year. The projects implemented (completed) during the year directly benefitted around 10,000 people and there has been a significant improvement in the socio-economic conditions of people.

Under a project implemented by ICAR-Central Marine Fisheries Research Institute (CMFRI) in Vypin and Paravoor blocks in Kochi and Ernakulam district of Kerala, the Scheduled Caste fisherfolk are being empowered through creation of location specific interventions in marine fisheries sector and entrepreneurial capacity building of Self-Help Groups in Marine Sector.

The interventions on (a) Seabass Cage Farming (b) Pearl spot Seed Production and (c) Fish Fertilizer will benefit 100 families through establishment of 30 micro-enterprises



Fig. Seabass cage culture

An ICT enabled integrated rural nutrition center has been established at Ettimadai village in Madukkarai block of Coimbatore District, Tamil Nadu, benefitting 300 direct and 3200 indirect beneficiaries. The nutrition centre will develop digital and ICT solutions for mapping of resources, vulnerability, services pertaining to Food, Nutrition, Health and Water and Sanitation on a GIS platform apart from continuous monitoring of nutrition using image processing on picture of plate, and detecting food category intake. A mobile application will be developed for farmer networking to track raw/food materials availability. The mobile application also helps for symptom collection and analysis of nutritional shortcomings of the SC population

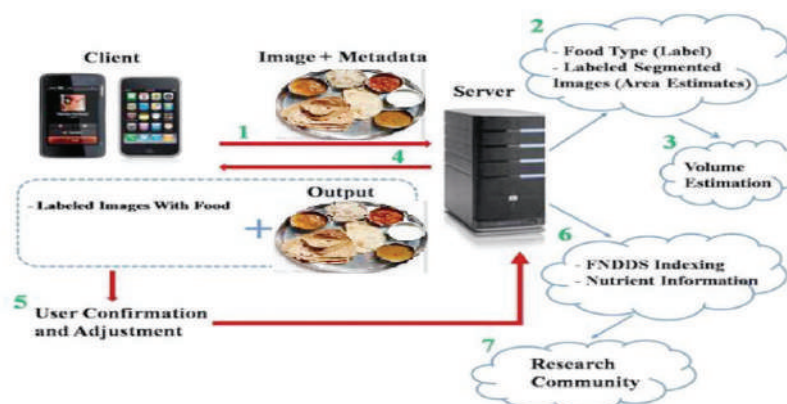

Fig. Proposed Architecture of Mobile Application

A network programme was implemented on identifying a set of technological innovations to revive the less intervened crafts like Andhra (Budithi) Bell Metal Craft, Kannauj Itr Making and Rajasthan Namda Craft. The technological interventions resulted in use of improvised machines, product diversification, design of ergonomic workplace, reduction in drudgery, improvement of product quality/finish, improved packaging techniques etc.

The traditional bell metal craft (Budithi) of Srikakulam district, Andhra Pradesh has been revived through technological interventions and innovations. A total of 1000 designs for apart from 50 designs each on wood and metal were collated for design diversification. The casting skills of the artisans were improved through trainings by involving Andhra University. 87 SC families involved in the Budithi metal craft are now using small mechanized tools and improvised furnaces. 200 small objects and 20 medium objects and 300 clay objects have been crafted with improvised designs there by reducing production time, improved finishing, higher market price leading to improved livelihoods and income generation.



Fig. Glimpses of Activities under the project

The Foundation for MSME Clusters (FMC), has designed and developed a low-cost carding machine for Namda Weavers of Tonk, Rajasthan hat reduce the extensive dust pollution as well as drudgery due to rigorous manual nature of production of Namdah craft articles.

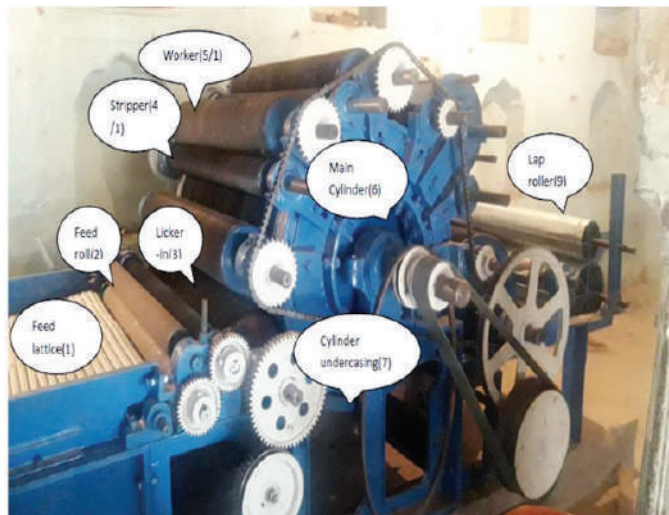

Fig Existing Carding Machine (left) and Improved Carding Machine (right)

The improvised machine reduces dust pollution substantially by arresting the dust in a covered box, thereby enhancing the quality of the wool by dust segregation. The production efficiency has increase by 85% (200 kg of wool in 8 hours) and the gears and pulleys are covered thereby increasing the safety of the machine. There has been a reduction in drudgery by 50% and 70% in dust pollution. Under casing of the machine controls aero dynamics of the card thereby the micro dust accumulates under the machine thus reducing the dust deposition on the skin of the operator. 10 artisan groups are current using these machines and another 100 cluster are in the process



Fig. Improved Deg Bhakpa Unit

of adopting the new technology. Potentially entire 400 plus cluster firms can adopt the new technology. Improved production technology and standard specifications for quality control were developed by Fragrance & Flavour Development Centre, Kannauj and Forest Research Institute (FRI), Dehradun for upgrading the attar value chain of Kannauj. Improved production techniques for production of attars of jasmine, marigold and vetiver oil has resulted in increased fuel efficiency by 48% for attar and 16 % for oil. The improvised Deg-Bhapka Unit also recued the occupational hazard and the quality of attars and oils was increased. The chemical and odour profiling of the attars produced by improved techniques has also been compared with those produced by traditional processes which lead to development and standardization of the improved production techniques for commercially traded attars of Jasmine, Marigold & Vetiver oil.

3.7.2 Tribal Sub Plan

The S&T interventions had directly benefitted 6000 people, in addition to improved socio-economic status there had been a significant improvement in skills, building on local innovation & local knowledge. The interventions also promoted alternative livelihoods through innovative community-based approaches, local (natural) resource management and technological options. Some of the significant outcomes under the scheme during 2020-21 are as follows.

1. Forest Resource Centric Interventions were standardized and scientific practices were promoted for sustainable livelihoods of 500 tribal families in Gadchiroli,
2. Maharashtra. The interventions include scientific practices of lac cultivation, inland fishery, integrated bodi farming and improvement of traditional methods for conservation of the Indian Magur. The project has piloted approaches for diversified livelihoods of tribal families, resulting in resilience building, income increase and improved nutrition, while conserving the natural resources.

Detailed phyto-sociological studies were done on Wild Edible Plants (WEP) and around 150 wild-edible species were identified in Male Madeshwar hills in Chamrajanagara district of Karnataka. Around 15 of these WEPs namely *Asparagus recemosus* (Shathavari), *Curculigo orchioides* (Musali), *Limonia acidissimma* (wood apple), *Decalipis hamiltonii* (Swallow root), *Syzygium cumini* (Jamoon), *Tamarindus indica* (Tamarind), *Dendrocalamus strictus* (Bamboo), *Holostemma annulare* (Holostemma), *Acacia farnesiana* (Sweet acacia), *Carissa carandas* (Bengal current) are prioritized for harnessing their potential for livelihood development and bio-resource conservation. Value added products from the 15 under utilised WEPs provided additional livelihood opportunities for the tribal communities of Male Madeshwar hills. Enterprenuership activities were promoted along with S&T capacity building of the tribal population. The ST youth were trained in processing of WEPs.



Figure WEPs and Training of ST Youth in processing of WEPS

A vaccine for mycoplasmosis has been developed by Faculty of Veterinary Sciences and Animal Husbandry, Sher e Kashmir University of Agricultural Science and Technology, Srinagar from local isolates of the mycoplasma is highly effective in prevention and control of mycoplasma diseases among small ruminants (sheep & goats) reared by tribals in Ganderbal of Kashmir valley and Kargil district of Ladakh region in J & K.

Livelihoods of Gujjars and Bakarwals (involved in livestock rearing) in Rajouri, Dhangri and Nowshera blocks, in Rajouri & Poonch district of Jammu & Kashmir is strengthened through adaptation of improved mechanized skills resulting in yield enhancement and control on the mortality rate of animals. A total of 120 families having an average flock Size of more than 500 have an improved access to livestock health management and rearing practices including wool processing and marketing facilities.



Fig. Shepherds with Wool Shearing Machines at Lah Village, Rajouri

5. A project on “Empowerment of tribal community for sustainable livelihood generation through organic cultivation and production of essential oils from Tulsi” is being implemented in Angarapara, Chatabar and Mendhasala gram panchayat, in khurda district of Odisha. covering 10 villages viz., Jamujhari, Palaspur, Paniora, Minchinpatna, Majena, Mahula, Haridamada, Barapita, Angarpara and Durgapur with population of more than 10,000 people. The value added products of Tulsi plant like essential oil by hydro distillation method, extract, powder and Tulsi tea have become an alternative income generation avenue for the community of 30 nearby villages also. Identification of quality oil yielding Tulsi germplasm, its distribution for sowing and establishment of small scale production unit in the vicinity of rural community is helping in entrepreneurship development amongst the youth.



Fig. Extraction of Tulsi Oil

Science Technology and Innovation (STI) Hubs: Six STI Hubs were established to develop, nurture and ensure the development, improvement, and delivery of appropriate and relevant S&T approaches for Creation of Sustainable Livelihoods and enhancing the Quality of Life of the Scheduled Caste and Scheduled Tribe population in the country. The two STI Hubs established at Dr. Babasaheb Ambedkar Marathwada University (BAMU), Aurangabad and Sidho-Kanho-Birsa University, Purulia during 2019-2020 became fully functional. The STI Hub at BAMU had developed 9 location specific technologies and 8 micro enterprises were established. Two mobile apps (sarathi and mazi shala) were developed and a Village Information System was developed for all the target villages.



Fig Screenshots of Sarathi App (left) and Mazi Shala App (Right)

COVID-19: Resilience & Capacity Building of SC and ST Communities at Grassroots:

The NGOs and KIs implementing projects under SCSP and TSP Schemes have responded on the ground with food (dry ration and hot cooked meals), Personal Protective Equipment (PPE), development of innovative tools and techniques and designing framework for protecting the existing livelihoods and creating alternate livelihood options in the States of Andhra Pradesh, Haryana, Himachal Pradesh, Kerala, Maharashtra, Manipur, Odisha, Rajasthan, Tamil Nadu, Tripura, Uttarakhand, Telangana and West Bengal. The network has approximately reached 70,000 SC people and 26,000 ST people in the above states. Relief material was provided 60,000 people and sanitizers to 36,000 people. 500 awareness and training programmes covering approximately 35,000 people were conducted and 56,000 masks were distributed. 25,000 face shields were distributed among the frontline health workers. The livelihoods of 12,000 households were protected/augmented with various S&T interventions in the fields of agriculture, aquaculture, collection of NTFP and other non-farm activities.



Fig Glimpses of Activities during COVID-19 Outbreak

Scholarship/Fellowship Programmes in Biomedical Science and Technology: The benefits of Biomedical Science and Technology is being extended to ST communities through all level participatory engagement by allocating dedicated scholarship/fellowship to the candidates belonging to ST community for doing summer scholarships in +2/UG/PG, PhD/Master's program, DM/MCH, PG Diploma/Diploma, MPH, M. Phil courses. The Scheme implemented by Sree Chitra Tirunal Institute for Medical Sciences & Technology, Kerala with financial support of DST aim to bring an impact on the education, skill development and employability of Scheduled Tribe (ST) communities in the country in the field of Biomedical Science and Biomedical Technology.

3.8 Drug and Pharmaceutical Research

Drugs and Pharmaceuticals Research Programme aims to synergize the strengths of publicly funded R&D institutions and Indian Pharmaceutical Industry, to create an enabling infrastructure for facilitating new drug development in all systems of medicines, both for human and veterinary purposes.

DST, through DPRP Program, has setup the following 2 National Facilities in year 2020.

- Strengthening of national facility for biopharmaceuticals services for bioprocess training and biopharmaceutical characterization (Phase II) funded to Guru Nanak Khalsa College Matunga, Mumbai. This facility aims at establishment of a complete end to end biosimilar characterization lab, which can answer the specific needs of the growing biopharma sector; be the interface for Industry- academic collaboration; serve as a finishing school for students, researchers and industry experts in key areas of biopharmaceutical product development.
- Development of National facility for bioanalysis funded to Dr. Babasaheb Ambedkar Marathwada University, Aurangabad, Maharashtra. This facility aims at providing validated bioanalytical support at regional, state and national level to small medium and large-scale pharmaceutical industries, National laboratories, University departments and Academic institutions involved in pharmaceutical RD activities to food and food products. Thus, financial burden on investments in high end bioanalytical facilities for these stakeholders can be eased out.

3.9 Good Laboratory Practice (GLP)

Good Laboratory Practice (GLP) is a quality system under which non-clinical health and environmental safety studies are conducted on various chemicals viz. Industrial Chemicals, Pharmaceuticals (Human and Veterinary), Agrochemicals, Cosmetic Products, Food/ Feed additives, Medical Devices, etc. The National Good Laboratory Practice Compliance Monitoring Authority (NGCMA) was set up under the administrative control of Department of Science and Technology (DST) in August, 2002 to provide GLP certification to the test facilities, which are involved in conducting safety studies on such chemicals in accordance with Organization for Economic Co-operation and Development (OECD) Principles of GLP. India is a full adherent to OECD Council Acts related to Mutual Acceptance of Data (MAD) since March 3, 2011, which ensures that the data generated by the GLP certified Test facilities in India is acceptable in the 37 member-countries of the OECD and other countries, thus removing the technical barriers to trade.

As on date, there are **50 GLP certified test facilities** in the country.

Some of the major achievements of the Indian GLP programme during the financial year 2020-21 are given below:

Interactions with OECD Working Group on GLP:

- The OECD has acknowledged the contribution of the Indian GLP program and designated India as the Vice-Chair of the OECD Working Group on GLP for 2021 and 2022.
- Representative of NGCMA, India attended the 34th meeting of OECD's Working Group on GLP held during February 16-18, 2020.

- The On-Site Evaluation of Indian GLP Programme was due in 2020. However, due to COVID-19 pandemic, the same would now be re-scheduled. NGCMA is in process of preparing for the same.
- During the COVID-19 pandemic, a new procedure for conducting Office Based Inspections for GLP Certified Test Facilities (GLP-120) has been developed & the GLP inspections are being carried out in a virtual mode.
- Grant of GLP re-certification and Extension in scope of GLP certification & periodic surveillance(s) of certified test facilities were done as per the laid down procedures of NGCMA.

Impact Analysis of National GLP Programme: An Impact analysis study has been conducted to assess the industrial, societal and governmental benefits of the National GLP Programme. The report of the study presents a comparison of the pre and post periods of India attaining a full adherence to Mutual Acceptance of Data (MAD) status in the OECD's Working Group on GLP. The study has brought out the strengths of the National GLP Programme along with the benefits offered by India's full adherence to MAD status to various stakeholders. At the same time, the report has thrown light on the challenges and future activities to be taken by NGCMA to meet the same.

Digitization of the National GLP Programme and Revision of working documents of NGCMA: An on-line portal for GLP certification has been developed to ensure transparent and speedier process of GLP certification. This includes Application filing, constitution of GLP inspection teams, reporting of GLP inspection results, filing of compliances to the inspection observations and grant of GLP certificate. Further, the procedural documents as well as the inspection procedures of NGCMA (including all working documents of NGCMA) were reviewed with the support of a Documentation Committee constituted with the approval of Chairman, GLP Authority and revised.

3.10 Patent Facilitation Programme (PFP)

Technology Information Forecasting and Assessment Council (TIFAC) an autonomous Institute of DST is implementing Patent Facilitating Centre (PFC) through its Intellectual Property Division and is responsible for creating IPR awareness and deeper understanding of patents and in the country. It also facilitates filing, granting, maintaining, and sustaining patents. It further provides patent information as an input to R&D and handles IPR policy matters.

IP/Patent Facilitation

PFC in the pursuit of facilitating filing and prosecuting patents and other IPR applications on behalf of academic institutions and Government R&D Institutes had filed 12 new patent applications after due assessment of patentability of 43 new requests and 70 requests are

under process. These patent and IP applications were drafted and filed through patent attorneys empanelled with PFC-TIFAC. The cost of filing these patents is borne by PFC TIFAC and patent/IP applications are filed on the name of inventing institute/s. PFC conducts patentability assessment in house for all the invention disclosure received by it. During this period 13 patents were granted in India are given in Table-I. PFC facilitated filing and prosecution of these patents.

List of Patents Granted in India Facilitated by PFC

S. No	Patent Number	Date of Grant	Applicant	Title
1.	343590	07-08-2020	Tezpur University, Tezpur	Novel soil conditioners
2.	342782	29.07.2020	Indian Institute of Technology, Kharagpur	Method or Apparatus to Detect the Micro-Calcifications in X-Ray Images using Nonlinear Energy Operator
3.	346112	04.09.2020	1. Anna University, Chennai and 2. University of Hyderabad, Hyderabad	Solution grown organic single crystal n-benzyl-2-methyl-4-nitroaniline and a method of growing thereof for terahertz applications'
4.	346678	14.09.2020	PEC University of Technology, Punjab	One pot synthesis of a new series of acyloxy-amide and acylamino-amide dihydropyrimidone derivatives
5.	347173	20.09.2020	Indian Institute of Technology, New Delhi	A method of evaluation and grading of textile or fabric or garment appearance
6.	348017	28.09.2020	Rajagiri School of Engineering & Technology, Ernakulam	High speed microprocessor design and implementation
7.	349459	16.10.2020	Bhavnagar University, Bhavnagar	Method for coating nano-magnetic particles with pharmacologically active substance
8.	349884	22.10.2020	Indian Institute of Technology, New Delhi	An apparatus and method for wireless personal area network and wireless body area network using magnetic coupling
9.	350155	27-10-2020	Punjab University, Chandigarh	Novel nanoemulsion/ self nanoemulsifying drug delivery system for enhanced oral bioavailability of hydrophobic selective β 1-adrenoreceptor blocker

S. No	Patent Number	Date of Grant	Applicant	Title
10.	352126	24.11.2020	Guru Nanak Dev University	Aza-heterocycle based compounds as highly effective anti-inflammatory agents
11.	352616	27.11.2020	Indian Institute of Technology, Kharagpur	A low cost, portable and drift corrected semiconducting metal oxide gas sensor device and process for domestic and industrial applications
12	353566	14-12-2020	University of Delhi	A sustained release and long residing ophthalmic formulation
13	354372	23.12.2020	Panjab University	Validated HPTLC and stability indicating HPLC method for prasugrel hydrochloride

Training Programmes and workshops

- Due to pandemic all training and awareness activities were conducted online in webinar mode on Cisco WebEx platform. Seven such programmes were organised besides special talks delivered by officials in various IP related events.
- Training programme on IPR in association with DST, Government of Rajasthan for Universities in Rajasthan starting from April 16, 2020 to April 21, 2020 [Lockdown period].
- Webinar Series “IPR through patent, copyright and trademark” being organized by TIFAC during 23-26th June 2020 in association with Goa State Council of Science and Technology, Goa.
- A 2-day joint webinar on “Intellectual Property Rights” organised in association with Pushpa Gujral Science City, Jalandhar Kapurthala Road, Punjab during 15-16th July, 2020.
- A 2-day joint webinar on “Intellectual Property Rights” organised in association with Mizoram Science, Technology & Innovation Council (MISTIC), Aizawal, Mizoram during 10-11th August, 2020.
- A 4-day joint webinar on “Intellectual Property Rights: Fundamentals and its importance in present context” organised in association with Uttarakhand State Council for Science and Technology (UCOST), Deharadun, Uttarakhand during 08-11th September, 2020.
- A virtual session on “Race Against Coronavirus” in association with European Patent Office and European Business Technology Centre (EBTC) was organised on November 25, 2020. ED TIFAC and officials of IPR division presented the work done on Covid-19 related technologies in patent documents.

3.11 Technical Research Centre

This programme was launched as a follow-up of the budget announcement made by the Hon'ble Finance Minister of India in his Budget Speech in FY 2014-15. Five Technical Research Centres (TRCs) were established with a mission to provide techno-legal-commercial and financial support to scientists, entrepreneurs, and business fraternity to achieve translation of research into products and processes for greater economic and societal benefits in 5 DST institutions namely, Sree Chitra Tirunal Institute for Medical Sciences and Technology (SCTIMST), Trivandrum; International Advanced Research Centre for Powder Metallurgy and New Materials (ARCI), Hyderabad; Jawaharlal Nehru Centre for Advanced Scientific Research (JNCASR), Bengaluru; Indian Association for the Cultivation of Science (IACS), Kolkata; and S.N. Bose National Centre for Basic Sciences, Kolkata during FY 2015-16.

The TRC programme is translating scientific discoveries and technological inventions into products and services of societal and industrial relevance. TRCs have been instrumental in building R&D translation ecosystem by supporting advancements in technology readiness levels of background R&D capabilities and intellectual properties, streamlining multi-stakeholder involvement (including industry-academia partnerships), technology out-licensing, setting-up platforms for start-ups, and strengthening state-of-the-art R&D infrastructure. Around a dozen of technologies have been transferred to the industries and many of them are at different stages of developments for transfer to the industries.

The significant achievements made so far under these TRC centres during the year of report are given below:

Technical Research Centre @ IACS-Kolkata

The Technical Research Centre (TRC) at IACS aims to utilize wide-ranging scientific expertise of its faculty members for translational research under the following themes:

- Quantum Materials for Application
- Materials for Energy and Environment
- Polymers, Disordered, Soft and Nanobio Materials for Devices, Diagnostics and Therapeutics
- Molecules: Understanding, making and exploring commercial viability.

Significant achievements

- Today biodegradable polymers are considered as the future, sustainable and green substitute to the majority of existing polyolefin based non-degradable polymers. We have started developing non-covalent supramolecular strategies for constructing tailor-made polylactic acids (PLAs) and subsequently study the effect of supramolecular interactions

in the structure, properties and degradation kinetics of this class of polymers. Such a systematic study is of importance for advancing engineering of the prevailing properties of the PLA, which is emerging as a bioplastic of translation significance.

- Development of an advanced oxidation methodology for colour and cyanide removal from the industrial waste-water in collaboration with TATA Steel Ltd., Jamshedpur
- Optimization of a mass spectrometry based analytical method for identification of molecular isomers from complex mixtures.
- Screening of drugs using primary mouse tumor cells has more impact than using conventional tumor cell lines. A protocol has been developed to generate primary mouse tumor cells which can be maintainable in the laboratory for the screening of drugs.
- Theoretical demonstration of rectification and switching behaviour in CdS-ZnSe coupled quantum nano-dots. These systems may serve as an alternative to molecular electronics. Theoretical prediction of Rashba effect in nitride perovskite LaWN₃, a novel quantum material for spintronic application.
- Morpholino oligonucleotides are important molecules which are used for the treatment of Duchenne Muscular Dystrophy (DMD). In order to make it in India, the synthesis of morpholino oligonucleotides have been standardized in the solid phase method.
- Demonstration of giant electrocaloric effect in lead-free ferroelectric perovskite thin films for eco-friendly solid-state cooling applications and development of a bespoke test set-up for the direct measurement of electrocaloric temperature change in ferroelectric materials using ultrafast IR imaging techniques have been completed.
- Small molecule functionalized polylactide nanoparticle and hyperbranched polyglycerol dendrimer are synthesized. These materials show anti-amyloidogenic activity and inhibit polyglutamine aggregation in cell model.
- Designed a five-layered face mask that will act as personal protective equipment (PPE) for viruses e.g., COVID-19. The engineered system has virus inactivation properties owing to the electrostatic charges. The work has been applied for Indian Patent (Patent Application no.: 202031048853).
- Discovered the highly efficient cellular uptake pathway of synthetic macromolecules by reactive disulfide-cell surface thiol exchange reaction. This discovery may make lasting impact in the drug delivery, gene delivery and other biomedical applications. Development of synthetic methodology for bioreducible hyperbranched polymer and testing the scope in targeted drug delivery application in cancer cells is under progress.

Technical Research Centre @ JNCASR-Bengaluru

The TRC at JNCASR has been instrumental in building R&D translation ecosystem by

supporting advancements in technology readiness levels of background R&D capabilities and intellectual properties, streamlining multi-stakeholder involvement (including industry-academia partnerships), technology out-licensing, setting-up platforms for start-ups, and strengthening and sharing state-of-the-art R&D infrastructure.

Significant achievements

- In times of COVID-19 pandemic, TRC initiated a few R&D projects with translational potential to strengthen country's capability in catering to healthcare requirements. To develop and deploy solution towards the fight against SARS-CoV-2, TRC conceptualized and initiated an R&D project on developing a "High throughput assay to target the evolutionarily conserved proteases of Coronaviruses". This project could have the potential to come-up with repurposed drugs effective against SARS-CoV-2.
- Scientists at JNCASR have developed an antimicrobial coating that is meant to prevent surface mediated spread of infections, and is claimed to be efficacious against different drug resistant bacteria, fungi, and viruses, including influenza, and thus, may also be effective against SARS-CoV-2. While the novel compounds are being tested against SARS-CoV-2, TRC has been in discussions with multiple companies to deploy products based on the said technology.
- With TRC support, JNCASR spun-off Breathe Applied Sciences Pvt. Ltd.. Breathe is one of the five finalists – the only start-up from Asia – of the \$20 million NRG COSIA Carbon XPRIZE – a global competition to develop breakthrough technologies that will convert CO₂ emissions from power plants and industrial facilities into valuable products like alternative fuels. Breathe has also been recognized as the Top-100 start-up company by the Government of Karnataka under its prestigious Elevate Program.
- Under its technology commercialization activities, TRC facilitated a Licensing Agreement with an industrial collaborator for the development of a method for cardio-vascular prognosis and diagnosis based on computer imaging assisted tools and prediction of Fractional Flow Reserve (CT-FFR) using fluid dynamics.
- To intensify its interaction with industrial players, TRC facilitated an industrial partnership for analysing coke deposit samples of aviation fuel produced under various process conditions. This study may help in development of a viable strategy for limiting coke deposition which can improve jet-engine performance.
- With an aim to overcome challenges in health, energy, transport, solar, supply of raw materials, resource efficiency, climate action, etc, TRC at JNCASR has initiated translational R&D projects viz, "Hypothesis-free clinical diagnosis via macrocyclic 'chemical-nose' sensor" for early detection of Preeclampsia, which is a leading cause of maternal and perinatal mortality and morbidity in India; and "Development of next generation materials for water purification, storage and harvesting".

- A Collaborative Research Agreement was executed through the TRC with an industrial partner for the “Study of Convection with Phase Change and Radiation”. Convection involving phase change has many engineering applications like solidification, Chemical Vapor Deposition (CVD) process, clouds and fog in atmosphere.

Technical Research Centre @ SCTIMST-Thiruvananthapuram

The Technical Research Centre (TRC) at SCTIMST has been continuously making an effort to develop cardiovascular devices, neuro-prosthetic devices, hard tissue devices (Dental, Craniofacial and Orthopaedic segments), in vitro diagnostics, biological and combinational products etc. During the current year, three new R&D projects were initiated. The total number of projects being executed has risen to 41. One technology transfer agreement for the ToT of blood flowmeter was signed with M/s. EnProducts, Kochi during the period. Based on the Expression of Interest raised earlier, industrial partners were identified for four projects and the process of technology transfer has been initiated for these. The Industry Institute Partnership Cell (IIPC) carried out three training programs for the medical device industry and R&D personnel.

Significant achievements

- **COVID-19 Fast-Track Projects:** TRC for Biomedical Devices evolved a fast-track method to come out with many products. Based on these projects, twenty-four technology transfer agreements were signed with various industries. Twelve commercialisation activities have taken place during the past year from these technology transfers. Some of the commercialised technologies include, RNA isolation kit, swabs and viral transport medium (VTM) kits, swab collection and examination booths, disinfection bins and walkways and super absorbent gels.
- Hon’ble President of the Institute, Dr. VK Saraswath launched the Agappe Chitra Magna RNA Isolation Kit of M/s. Agappe Diagnostics, Kochi. The same product was later relicensed to M/s. Tata Sons, Mumbai
- The state-of-the-art customisable hospital for Covid- 19 management, Medi CAB developed by SCTIMST and Modulus Housing (incubatee at IIT Madras Research Park) is a deployable emergency response field unit. It is foldable and is composed of four zones – a doctor’s room, an isolation room, a medical room/ward, and a twin-bed ICU, maintained at negative pressure. It can be easily transported and installed anywhere and can be erected within few hours’ time.
- The Air Bridge EBAS (Emergency Breathing Assistance System) jointly developed by SCTIMST and Wipro 3D is a device that provide positive pressure and volume-controlled ventilation to a patient requiring immediate assistance or support in breathing. It provides sustained but temporary breathing/ventilation support in emergency situations, to patients with varying lung compliances. The device is undergoing clinical trials.



Fig. Chitra Magna RNA Isolation Kti



Fig. SCTIMST Medi CAB



Fig. Emergency Breathe Assistance System

Technical Research Centre @ SNBNCBS-Kolkata

The aim of the above Technical Research Centre (TRC) was to establish a research centre and create an eco-system for Make in India initiative in the country by harnessing science and technology platforms and leveraging on the existing core strength in materials science and spectroscopic techniques in the Centre. The Centre has so far transferred six technologies to industries, six prototypes are ready for Transfer of Technology, generated Several IPs through 24 national and one international patents, trained manpower (about 50) to cater the future need of the country and revenue generation through national and international consultancy projects / user charges.

Significant achievements

The following technologies were transferred to industries:

Technology Transfer	Industry Partner
Non-Invasive Screening for Neonatal Hyperbilirubinemia	M/s. ZynaMedtech Private Limited

Technology Transfer	Industry Partner
An active respirator with attached exhalation valve and suspended articulate matter filter for comfortable and hygienic breathing	M/s. Paulmech Infrastructure Private Limited
Long-lasting nano-sanitiser with a dispensing antimicrobial layer	M/s. Paulmech Infrastructure Private Limited

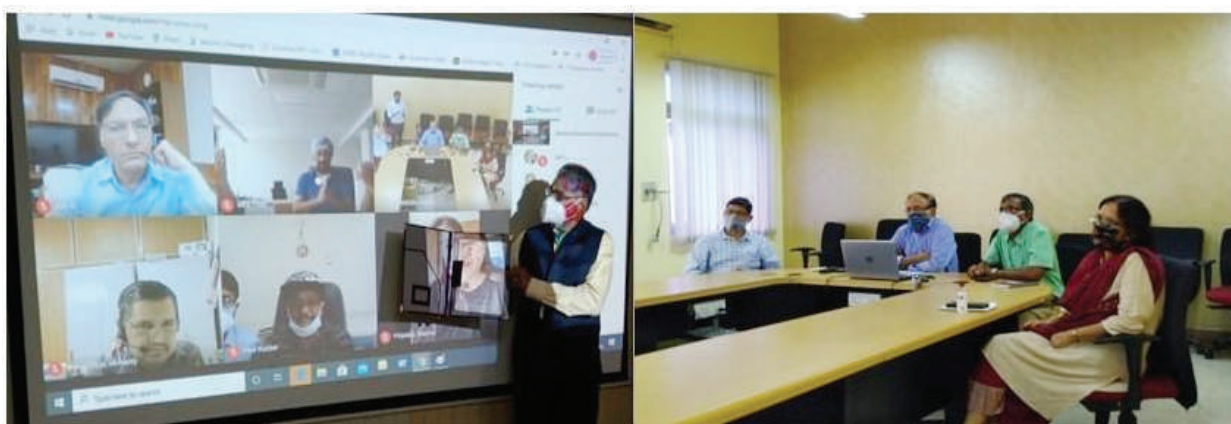

Fig. Transfer of Technology (TOT) through National Research Development Corporation (NRDC) of the above mentioned three technologies held on 13th July, 2020 in video conferencing mode

The Developed Prototypes ready for Technology Transfer

- A Non-invasive Breath Analyser for the Detection of Peptic Ulcer Disease, Non-ulcerous Dyspepsia and *Helicobacter Pyroli* Infection
- An Optical Emission Spectroscopy (OES) based Sensor for Minimally-invasive Detection of Essential Electrolytes in Human Body (NaLiK)
- A Spectroscopy-based Optical Device for Estimation of Milk Quality (MIL-Q-WAY)
- A Flexible paper-based highly sensitive sensor for ammonia gas detection by visual effects (Ammo-Watch)
- A Spectroscopy Based Fluoride Sensor in Drinking Water (FeFlu)
- A Chromogenic Nanocomposite-based Optical Device to Detect Carbon Dioxide Content in Human Exhale Breath for Potential Diagnosis of COPD Disease (CapNanoScope)

Technical Research Centre @ ARCI-Hyderabad

The overall objective is to build-up technology strengths in the field of “Alternative Energy Materials & Systems” to reach a maturity level that is necessary for prototype development and demonstration in a PPP mode and facilitate subsequent technology assimilation by

the automotive industry and other energy related industries. The TRC comprises of sub-programs in the broad areas:

- Energy storage (batteries & supercapacitors);
- Energy conversion (fuel cells);
- Energy efficiency (Magnets for motors, waste heat recovery);
- Renewable energy generation & efficiency improvement (Solar CSP, PV)

Significant achievements

ARCI Li-ion Battery for EV: e-scooter demonstrated (TRL 6/7).

- Established Li-ion battery fabrication demo line for ~30 kW capacity/year
- Agreements with HPCL (know-how seeker) and Hero electric (User) for field testing on e- scooter; Agreement with Leep E-drive for e-auto rickshaw and setting up 1-5 MW hr/yr LIB cell manufacturing with ARCI technical know-how. Proposal for TDB funding to establish the first LiB cell manufacturing plant in the country under submission.

ARCI Li-ion Battery for stationary applications: Solar powered LED street lamps demonstrated (Reached TRL 6/7)

- *Agreement with ITIL to set up LIB plant of 5 MWhr/yr capacity*

Li-Ion Battery electrode materials technology:

- Anode: Cost effective Lithium Titanate (LTO) manufacturing technology (TRL 7) – *discussions underway for technology transfer with two companies*
- Cathode: Lithium Iron Phosphate (LFP) manufacturing technology (reached TRL5) – *discussions underway for technology transfer with two companies*; Lithium Nickel Manganese Cobalt Oxide (NMC) (reached TRL4) – upscaling being attempted

Soft and Hard Magnets for alternator/motor for EV and other applications:

- New cost-effective Fe-P soft magnetic alloy developed (TRL6) and demonstrated for alternator and motor application with industrial partner. Repeatability and large-scale processing under evaluation.
- Hard magnetic ferrite powders for automotive applications with superior magnetic properties have been developed. Lucas TVS and Ashwini magnets have signed agreement to collaboratively develop the products and productionise

PEM Fuel Cell Technology:

- Stationary applications (1-5 kW systems) demonstrated at various places where hydrogen is available, including disaster management

Supercapacitor Technology

- Demonstrated Supercapacitor powered E-Bike with fast charging option for driving of 2 Km using supercap module (51V,188F) made from imported supercapacitor devices (3400F, 2.85V)
- *Cost-effective technology for porous carbon from petroleum coke (waste from oil companies) - Upscaling under progress*

Medium and High Temperature Receiver Tube Technology:

- Demonstrated medium temp stable prototype receiver (2m length) with 93% absorption and 0.12 emittance and high temperature prototype receiver tube (1m) with >95% abs and 0.16 emittance and thermal stability upto 500°C) using a *unique parabolic test rig facility set up*
- Transferred medium temperature stable absorber tube technology for industrial process heat application to the industry

Easy to Cleaning Coating Technology on PV panels

- Developed Easy to clean (hydrophobic property: > 110° water contact angle) coating on PV panels: low cost, simple coating technique, easy scalable, curable at ambient temp., no loss in transmittance / efficiency, high environmental stability (IEC 61646) and mechanical stability.
- Transferred easy-to-clean coating technology for application on solar PV panel for improved efficiency

Broadband antireflective coatings for CST and PV applications:

- Developed coatings with high transmittance and stability on CST cover glass tube and PV cover glass plate using MgF₂ hollow nanoparticles and SiO₂ nanoparticles synthesized by novel solvothermal process and demonstrated large-scale synthesis and coating on 1m CSP cover glass tube and 1 X 1 feet PV cover glass.
- Technology demonstration at industrial scale roll to roll process with interaction of Borosil Renewables Ltd is being progressed.



Fig. Highly transparent dust repellent coatings for PV panels Technology has been successfully transferred to NTPC Ltd by ARCI.

3.12 Exhibitions and Fairs

The Exhibition Cell is concerned with the work relating to organizing exhibitions, participation in science exhibitions at national and international level. In addition, it has also been assigned responsibility of coordinating the work of participation of Department of Science & Technology along with its organisations in science exhibitions. The aim of Exhibition Cell is organising exhibitions to bring awareness among students, scholars and general public about different Government policies, schemes, scientific innovations & milestones in the field of Science & Technology.

The activities of Exhibition Cell, DST during 2020-2021 were as under: -

- Organised India International Science Festival (IISF) – 2020 at virtual platform in association with Ministry of Earth Sciences, Departments of Bio-Technology, Scientific & Industrial Research and Health Research along with Vijnana Bharati (VIBHA - an NGO) during 22-25 December 2020.
- Organised activities under 150th Birth Commemoration of Mahatma Gandhi, such as setting up of 360° video immersive experience in a circular dome at Gandhi Darshan, New Delhi on 2nd November, 2020.
- DST is commemorating its Golden Jubilee Year during 3rd May 2020 – 3rd May 2021. Under this, Exhibition Cell has organised activities such as release of special cover, coffee table book (e-book) etc.
- The Cell also coordinated with subordinate offices and autonomous institutions working under the Department for participation in a number of activities.



Fig. Dr. Harsh Vardhan, Hon'ble Minister Health & FW, Earth Sciences and Science & Technology, Shri Sanjay Dhotre, Union Minister of State for Communications, Education and Electronics & IT, Shri Ashutosh Sharma, Secretary (DST) & Shri Dushyant Mudgal, Director, Postal Services releasing Special Cover in connection with Golden Jubilee Commemoration of DST 182053/2020/Exhibition 12



Fig. Dr. Harsh Vardhan, Hon'ble Minister Health & FW, Earth Sciences and Science & Technology & Shri Prahlad Singh Patel, Hon'ble Minister of State (Independent Charge) for Culture are inaugurating 360° video immersive experience in a circular dome at Gandhi Darshan, New Delhi on 2nd November, 2020 182053/2020/Exhibition 13

3.13 National Spatial Data Infrastructure (NSDI)

National Spatial Data Infrastructure (NSDI)'s vision has been to ensure that "current, accurate and organized geospatial data sets are readily and continuously available and accessible on a national, state, district and village level basis to contribute to economic, environmental and social growth of the country". Five strategic goals set for NSDI include establishing required governance structure, ensuring capture, preservation, and maintenance of both fundamental and non-fundamental data sets; ensuring that the governmental geospatial data sets are readily discovered, appraised, and accessed; ensuring that the geospatial data sets, services, and systems owned by different government agencies are interoperable, and can be combined and reused for multiple times; and providing a coordinating framework for the delivery of the desired product space for its multiple stakeholders.

Towards the above goals, during 2020-21, focus of the NSDI has been on demonstrating the National Data Registry (NDR) Geo-portal and the individual organisational Data Nodes; provisioning a proof-of-concept Geospatial Cloud based Infrastructure (NSDI Geo-platform) services for hosting geospatial data/ applications; maintaining the NSDI Clearinghouse Node as a single window gateway for access to digital geospatial data; maintaining the on-going and establishing new State Geoportals in various States; coordinating the development of National and State Level Geospatial Foundation Data and applications; framing and using geospatial data and process standards with the involvement of the Bureau of Standards (BIS); and the revision of the draft National Geospatial Policy.

National Data Registry (NDR)

Under the National Data Registry (NDR) Initiative, a set of on-line registers has been developed to facilitate search, discovery, and utilisation of on-line geospatial data sets and services for interoperable access from 5 Central Partnering Agencies and 1 State Agency Data Nodes (Figure 1). The registers provide an array of meta-level information for each feature data item covering its uniquely assigned identification code, concept or meaning of each theme or feature; geometric and attribute details (standards-based schemas); and possible values (code lists) for the attributes. NDR is expected to facilitate registering of data sets and provision of data services of various agencies thereby creating a framework for minimising duplication in data acquisition and maximising utilisation of already acquired data sets in various organisations

NDR geoportal has been demonstrated and made operationally accessible to NSDI and State SDI Partnering Agencies, experts and end users for registration and utilisation of data sets and services useful in querying and application development. Equipped with functionalities to document geospatial data sets/ services in standards-based registers, harvest/ re-harvest metadata sets from Partnering Agency Data Nodes; access a centrally-coordinated geospatial catalogue for utilising data sets in responding to end user queries, the NDR Geo-portal is expected to be a useful in improving geospatial data management and utilisation.

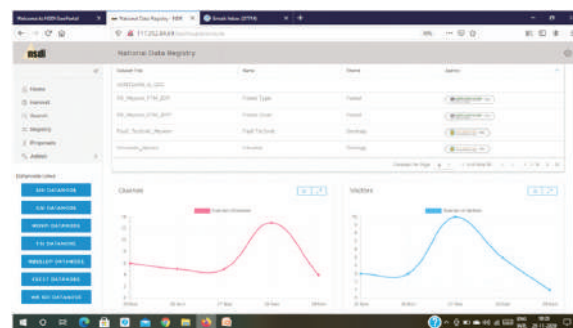

Fig. : National Data Registry (NDR) Dashboard accessible at <http://ndr.nsd.gov.in> for registration, harvesting, and catalogue services by NSDI Partnering Agencies

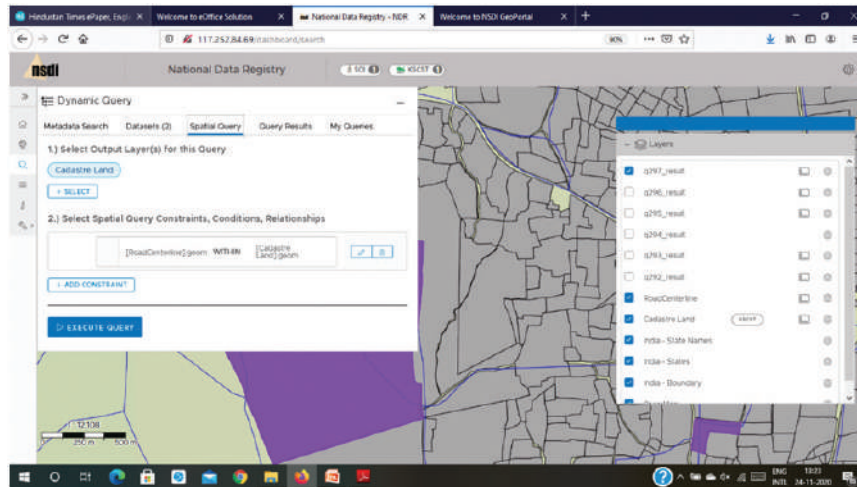

Fig: Executing geospatial queries using NDR's Dynamic Query Builder and interoperable data sets from multiple sources e.g. SOI and KSCST showing selected land parcels containing road centre lines in Mysuru District of Karnataka

Geospatial Cloud Platform

A proof-of-concept Geospatial Cloud-based Data Centre (NSDI Geo-platform) has been established in Survey of India (Hyderabad Campus) for evaluating the efficacy of Cloud Computing in the management, sharing, and processing of high resolution geospatial data sets of NSDI Partnering Agencies. Six Central Government Agencies (SOI, GSI; FSI; NBSS&LUP; MoSPI; and CPCB), six State Government Agencies implementing State Spatial Data Infrastructures (e.g. West Bengal, Arunachal Pradesh; Punjab; Uttar Pradesh; Karnataka and Goa) have utilised the NSDI Geo-platform for building up their respective Data Nodes towards quicker on-boarding of data services.

The Geo-platform has been utilised to demonstrate the complete work flow involving preparation, management, and publication of high resolution (1: 2,000

Parameters	Hostname	VCPUs (Prov)	VCPUs (Total)	vCPU over prov	RAM in GB (Prov)	RAM in GB (Total)	RAM over prov
CPU RAM	Compute1	106	72	147%	368	208	177%
	Compute2	84	72	117%	320	208	154%
	Compute3	96	72	133%	260	208	125%
	Compute4	54	72	75%	280	208	135%
	Total	340	288	118%	1228	832	148%
Parameter	Hostname	Provisioned Capacity	Total Storage capacity	Utilization			
Storage	Ceph 1 - 3	38.59 TB	40 TB	96%			

Fig. Proof-of-concept Cloud-based NSDI Geo-platform's existing CPU/ RAM/ Storage resource provision and utilisation

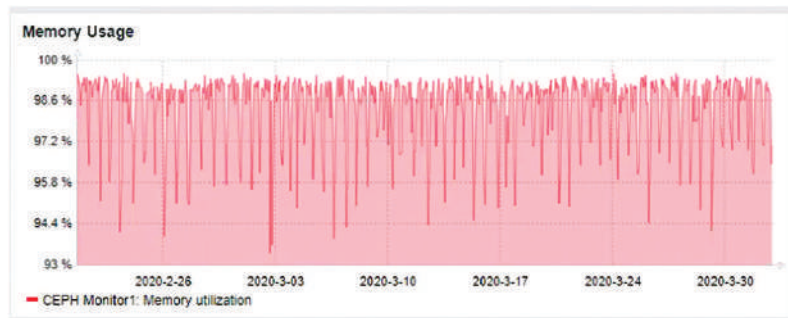

Fig. An indicative and typical memory utilisation status of the proof-of-concept Cloud-based NSDI Geo-platform

scale) 2D/ 3D data sets for Varanasi City prepared from the drone survey by utilisation of OGC/ ISO/ BIS Interoperability Standard Specifications. Aimed at incorporating data life cycle management processes to already existing National Urban Information System (NUIS) data sets of Varanasi and publishing the related data services in the NDR for web-based access, the study provides to the National Mapping and State Government Agencies a methodological framework for provision of high resolution up-to-date data, products, services and solutions to the end users on a scalable cloud-based computing platform for processing services and application development. SOI has also scaled up its compute resources for putting up the Geo-platform to use in the management of its regular and routine data sets. Considering the current level of resource provision and utilisation, the Geo-platform infrastructure is proposed to be upgraded with additional compute resources for provision of required services to the NSDI partners in the near future.

Partnering Agency Data Nodes

NSDI and State SDI Partnering Agency Data Nodes provide interoperable access to map (display/ visualisation) services. SOI's Surveykshan, NRSC/ ISRO's Bhuvan; NIC's National Data Portal; FSI's DSS Geoportal; GSI's Bhukosh; and NBSS&LUP's Bhoomi are being maintained and re-oriented for provision of Web Map/ Feature Services (WMS/ WFS) in the framework of the Service-oriented Architecture (SoA). Metadata and Data Services of the geospatial Data Nodes of the NSDI and State SDI Partnering Agency Data Nodes are maintained in collaboration with the respective Ministries/ Departments and the State Governments for sustained access to their data sets.



Fig NSDI Clearinghouse Portal (<https://nsdiclearinghouse.gov.in> or <https://nsdiindia.gov.in>) contains links to various National and State Geo-portals and the National Data Registry (NDR) Geoportal

Data Nodes/ Geoportals for States/ Union Territories (UTs) like Karnataka, Kerala; West Bengal; Uttarakhand; Jharkhand; Haryana; Odisha; Delhi; and J&K have been maintained/ developed for providing standards-based interoperable access to the geospatial data sets of the respective State Governments. During the year, Geoportals have been made accessible for States like Madhya Pradesh and Nagaland. Geoportal prototypes have been demonstrated for the States of Punjab and Goa.

The Partnering Agency Data Nodes have been accessible from the single window gateway of the India Geoportal (<https://nsdiclearinghouse.gov.in>) that is evolving as a Data Clearinghouse to support orchestration of Data Services and development of on-line GIS applications. India Geoportal has been migrated to a state-of-the-art and more secured hardware and software infrastructure for provision of the metadata and data services.

Application Services

State-wide consistent and seamless high resolution foundation spatial data sets have been identified as the starting point for developing geospatial applications. Based on the recommendations of the State SDI workshops, State Geo-portals are being upgraded and re-oriented to capture and share high resolution foundation data sets over the web for the Line Departments to add their thematic details, attaching attributes; geo-registering their maps; and linking & orienting their results of applications to the local landscapes. It has thus been recommended by the NSDI Executive Committee to prepare and share through the State Geo-portals foundation data sets in 1:2000 (panchayat level, 2D) and 1:500 (ward level, 2D/3D) scales. Towards coverage of one block and one city/ town each in Arunachal Pradesh and Odisha under the application development initiative, a System Integrator is being identified by each of the Partnering Agencies in the States. The study areas are proposed to be surveyed during the year using airborne optical and LIDAR sensors for sharing the resulting high resolution data sets as standards-based data services for the preparation of panchayat and ward level geospatial applications.

Developing and Utilising ISO/ OGC/ BIS Geospatial Standards

National standards on 'Rules for Application Schema', 'Conceptual Schema Language'; and 'Geography Mark-up Language (GML)' co-branded and published from the ISO/ OGC in the previous years have been utilised in the development and deployment of the NDR and State Geo-portals. ISO 19135 standard specifications for the procedures for registering geospatial objects have been used in the design and implementation of the NDR. NSDI has participated in the 19th meeting of the eElectronics & Information Technology Division (LITD) Council of the Bureau of Indian Standards (BIS) for the review of the Council's activities on the development of the National Standards in the domain of Electronics & Information Technology on 15th Sep 2020. A draft strategy for development and utilisation of standards has been finalised.

Training and Capacity Building

Demonstration of the NDR and the Geospatial Cloud platform services have been provided to a group of 40 participants including the NSDI Nodal Officers and the Principal Investigators from the State SDIs on 28 April 2020 in virtual mode. A group of 20 participants from the sector of Telecommunications of 11 Nationalities from the Asia-Pacific Region have been exposed to the Indian experiences of implementing SDIs and their relevance to disaster management in a virtual training session organized on 05 November 2020 by the National Telecommunications Institute for Policy Research, Innovation and Training (NTIPRIT), Ghaziabad of the Dept. of Telecommunication, Government of India.

Interaction with OGC

Two virtual meetings of the Open Geo-spatial Consortium - India (OGC-India) Forum have taken place - one on 14 May 2020 and the other on 14 October 2020 with the stakeholders of open geo-spatial standards from the Government, Academia; and the Private Enterprises. Status of development and adoption of OGC standard specifications for interoperable sharing of geospatial data over the web have been discussed in order to work out future strategies.

R&D priorities

In line with the recommendations of the Brainstorming workshop on 'Geospatial Data Science' organised at the Indian School of Business, Hyderabad on 06 January 2020 on the sidelines of the ACM India Joint International Conference on Data Science and Management of Data (CoDS-CoMAD) and the recommendations of the NSDI Expert Committee held on 18 February 2020, topics like 'Development and testing of Autonomous Spatial Data Platforms', 'Geo-Cloud/ Edge Computing'; 'Geo-data/ Spatio-temporal Data Analytics'; 'Geospatial Machine / Deep Learning Techniques in various Application Domains'; and 'Management of countrywide image database and ocean-based data sets' etc. have been published in DST/ NSDI web-sites/ Geo-portals for inviting R&D proposals for the consideration of support.

Draft National Geospatial Policy

For further consultation with the NSDI stakeholders, the draft National Geospatial Policy has been revised to incorporate mandatory registration of all the data sets in the NDR to help develop a centrally-coordinated geospatial catalogues to facilitate search, access, delivery and utilisation of standards-based geospatial data. For easy access to geospatial data/ products/ services and solutions by efficient processing on a scalable PoC-based Geo-platform, the revised Policy provides for establishing a suitable geospatial infrastructure with the help of a managing partner.

Future

For implementation during 2020-2025, a conceptual framework for NSDI 2.0 has been developed and recommended in line with the next generation Integrated Geospatial Information Framework (IGIF) of the United Nations Global Geospatial Information Management (UNGGIM) Committee of Experts. Designed to be mounted on the NDR and a fully functional Geo-platform, NSDI 2.0 will be made operational by leveraging the outputs of NSDI 1.0 including the distributed network of geo-portals from the Partnering Central and State Government organisations; a well-knit team of scientists and experts built over the past years; and an innovative group of Private Enterprises/ Start-Ups/ System Integrators. With the framing of the National Geospatial Policy, the start-ups are proposed to be supported with the help of a group of identified coordinating hubs of NSDI for developing and providing geospatial application and solution services towards addressing the social, economic, and environmental challenges facing the nation.

NATIONAL MISSION ON INTERDISCIPLINARY CYBER PHYSICAL SYSTEMS (NM-ICPS)

The Union Cabinet has approved the National Mission on Interdisciplinary Cyber Physical System (NM-ICPS) in December 2018 at a total outlay of Rs.3660 Crores for a period of five years to be implemented by DST.

4.1 Mission Technologies

Various CPS and its associated technology verticals have been considered under NM-ICPS which includes: Artificial Intelligence and Machine Learning, Technologies for Internet of Things & Internet of Everything, Data Banks & Data Services, Data Analysis, Robotics & Autonomous Systems, Cyber Security and Cyber Security for Physical Infrastructure, Computer Vision, Augmented and virtual reality, Device Technology and Materials, Speech, Video & Text Analytics, Sensors, Networking, Actuator & controls, Autonomous Navigation and Data Acquisition systems (UAV, RoV etc), Data Analytics & Predictive Technologies, Technologies for Under water exploration, Human Computer Interaction, Cobotics, Intelligent Collaboration Systems, Technologies for Agriculture & Water, Technologies for Mining, Advanced Communication System, Bio-CPS, Data Science, Big Data Analytics and Data curation etc., System Simulation, Modelling & Visualization, Cognitive Computing & Social Censing, Quantum Technologies, Positioning and Precision Technologies and Technologies for financial sector (Fintech)

4.2 Mission Implementation Strategy

The proposed NM-ICPS is a comprehensive Mission aimed at complete convergence with all stakeholders by establishing strong linkages between academia, industry, Government and International Organizations. The Mission is implemented through 25 number of Technology Innovation Hubs (TIHs) established as part of the Mission in the top academic and National R&D Institutes. Each TIH will have four major activities i.e., 1. Technology Development, 2. Human Resource & Skill Development (including development of CPS technology application tools for education at elementary and high school level), 3. Innovation, Entrepreneurship & Start-Up Ecosystem and 4. International Collaborations.

4.3 Mission Implementation Model

The Mission has established 25 Technology Innovation Hubs. These TIHs are at the core of the implementation of the ICPS Mission as all major activities will be carried out through these Hubs. It plans to build linkages and collaborations with network of research institutes

and labs across India and abroad. TIHs would work in close collaboration with Industry to create symbiotic relationship and world class products development. TIHs will emphasize on development of infrastructure tools for direct application of basic and applied research leading to Technology Development, including development of new areas of CPS applications/ platforms. TIHs will provide the ecosystem for application based technology development and deployment. TIHs will also be responsible for delivering commercial technology, and taking ideas / concepts or prototypes and turning them into marketable products by way of proactive coordination, communication and interfacing for technology transfer to the industry. These would work closely with Startup ecosystem, Corporate, Governments and regulatory bodies as well. These would include webinars, events, workshops, grand challenges, hackathons and also online courses with live projects. Each Hub will specialize in a thematic domain and will connect with all institutes/ groups/ individuals who have expertise in that domain. It will coordinate across the country and will act as single point of contact for that particular domain. TIHs will collaborate with industry for fabrication/ services, work with nano-fabrication, material centers, other Centers and TBI's. International network – TIHs would connect to a global network of leading labs and institutes and researchers that can enable close research collaborations.

Under the Mission, each Hub to follow a technology life cycle approach, addressing all stages viz. Knowledge-Development-Translation-Commercialization. As Hubs are part of the technology life-cycle continuum in the Mission, these hubs will not have sharp boundaries of functions; overlapping of their operations will be encouraged to address the complete technology lifecycle, if the delivery and commercialization of technology is promising. With this design, each such hub will, on one hand have forward and/or backward linkage with each other; on the other hand, they will work in tandem with experts/ institutions outside or with other initiatives of government and international institutions. In the highly networked mode as each Hub would be, they will be equipped sufficiently to function independently as stand-alone entity, however, they would leverage each other's strengths and the power of collaboration to produce synergistic outcomes. This would ensure that there is a dynamic functional model where technologies being focused are driven by market demands.

Following are the 25 Technology Innovation Hubs established under NM-ICPS:

S. No	Host Institute	Technology Vertical	Technology Innovation Hub
1	IIT Kharagpur	Artificial Intelligence and Machine Learning	IIT KHARAGPUR AI4ICPS I HUB Foundation
2	IIT BHU, Varanasi	Data Analytics & Predictive Technologies	I-DAPT-HUB Foundation
3	IISC Bengaluru	Robotics & Autonomous Systems	HUB for Robotics and Autonomous Systems Innovation Foundation
4	IIT Hyderabad	Autonomous Navigation and Data Acquisition systems (UAV, RoVetc)	NMICPS Technology Innovation Hub On Autonomous Navigation Foundation

S. No	Host Institute	Technology Vertical	Technology Innovation Hub
5	IIT Bombay, Mumbai	Technologies for Internet of Things & Internet of Everything	TIH Foundation for IoT and IoE
6	IIT Madras, Chennai	Sensors, Networking, Actuator & controls	IIT Madras Pravartak Technologies Foundation
7	IIT Kanpur	Cyber Security and Cyber Security for Physical Infrastructure	IHUB NTIHAC FOUNDATION
8	IIT Guwahati	Technologies for Under water exploration	IIT Guwahati Technology Innovation and Development Foundation
9	IIT Jodhpur	Computer Vision, Augmented and virtual reality	IHUB Drishti Foundation
10	IIT Tirupati	Positioning and Precision Technologies	
11	IIT Patna	Speech, Video & Text Analytics	IIT PATNA VISHLESAN I-HUB Foundation
12	IIT Mandi	Human Computer Interaction	IIT Mandi IHUB AND HCI Foundation
13	IIT Hyderabad	Data Banks & Data Services, Data Analysis	IIT-H Data I-Hub Foundation
14	IIT Roorkee	Device Technology and Materials	DIVYASAMPARK IHUB Roorkee For Devices, Materials And Technology Foundation
15	IIT Ropar	Technologies for Agriculture & Water	IIT-ROPAR- Technology And Innovation Foundation
16	IIT Dhanbad	Technologies for Mining	Technology Innovation In Exploration & Mining Foundation
17	IIT Palakkad	Intelligent Collaborative Systems	IIT Palakkad Technology IHUB Foundation
18	IIT Bengaluru	Advanced Communication Systems	
19	BITS Pilani	Bio-CPS	
20	ISI Kolkata	Technologies for financial sector (Fintech)	
21	IIT Indore	System Simulation, Modelling & Visualization	IITI DRISHTI CPS-Foundation
22	IIT Delhi	Cognitive Computing & Social Censing	
23	IISER Pune	Quantum Technologies	
24	IIT Bhilai	Technologies for financial sector (Fintech)	
25	IIT Delhi	Cobotics	I-Hub Foundation for Cobotics

4.4 Current Status and progress

Following tasks related to implementation of NM-ICPS has been accomplished/initiated:

25 Technology Innovation Hubs have been established in various CPS Technologies and its associated technology verticals in academic institutes across the country.

- I) Tripartite Agreement are being signed between the Mission Office, Host Institute and Technology Innovation Hubs.
- II) The initial grant has been released to all the Host Institutes.

4.5 Mission under consideration

National Mission on Quantum Technologies and Applications (NM-QTA)

Government has announced a National Mission on Quantum Technology & Applications (NM-QTA) on 1st February 2020. Department of Science & Technology (DST) has prepared a Detailed Project Report (DPR) on NM-QTA.

Quantum Technology is based on the principles of quantum theory, which explains the nature of energy and matter on the atomic and subatomic level. It concerns the control and manipulation of quantum systems, with the goal of achieving information processing beyond the limits of the classical world. Quantum principles will be used for engineering solutions to extremely complex problems in computing, communications, sensing, chemistry, cryptography, imaging and mechanics.

NM-QTA is a pan-India Mission implemented through academic and R&D institutes spread across the country and projects are selected by subject experts. Duration of the Mission is 5 years.

Mission Objectives: Broad objectives is to develop Quantum Computers, highly secured Quantum Communication, Quantum Key Distribution (QKD), Quantum clocks quantum sensors, imaging devices, advanced quantum materials, Human Resource Development, international collaborative research and startups. The mission draws upon the existing deep strengths within academic institutes across India to support interdisciplinary research projects in key verticals involving quantum technology, while simultaneously developing key foundational strengths in important core areas.

Impact: On successful implementation of the mission it is expected that a quantum computer with around 50 qubits using at least one of the technological approaches pursued can be built in the country in a timeframe of 5 years. Smaller scale devices using most of the other approaches are also expected. Quantum communication – in particular quantum key distribution – across hundreds of kilometers through satellites and fibers are also expected as an outcome of the mission. Translation of quantum key distribution systems into field deployable products is also a planned deliverable for the mission.

AUTONOMOUS INSTITUTES

The Department of Science and Technology nurtures 25 Autonomous Bodies (ABs). These include 16 research institutions, 4 specialized knowledge and S&T service organizations and 5 professional bodies. These institutions, with long and cherished history and their variety of activities, occupy a very important place in the S&T eco-system of the country. Activities and achievements of autonomous institutes during the year under report are briefly described below:

5.1 Maharashtra Association for the Cultivation of Science (MACS)-Agharkar Research Institute (ARI), Pune.

The institute focusses on Biodiversity and Palaeobiology, Bioenergy, Bioprospecting, Developmental Biology, Genetics and Plant Breeding and Nanobioscience.

Major Accomplishments:

- A biocontrol agent Sulfate Reducing Bacteria Lytic Bacteriophage was developed for the inhibition of Sulfate Reducing Bacteria (SRB) and resultant H₂S production that cause oil reservoir souring. The biocontrol agent will be beneficial to oil industry and a potent weapon to fight SRB and prevent reservoir souring.
- ARI developed a biopolymer based hemostatic gauze and gel containing nanoparticles for halting blood loss during trauma. Also a nanoparticles based rapid, field-usable, lateral flow diagnostic assay was developed by ARI for the detection of *Macrobrachium rosenbergii* nodavirus (MrNV), a disease causing entity that severely affects the prawns farming in India.
- A new bio-fortified durum wheat variety MACS 4058 (enriched with essential nutrients such as Protein 12.8%, Zinc 37.8 ppm, Iron 39.5 ppm) was notified and released for timely sown restricted irrigation conditions of Peninsular zone (Maharashtra and Karnataka). This variety was included in a video released by the Hon'ble Prime Minister of India, on 16th Oct 2020 on the 75th anniversary of the Food and Agriculture Organization. The grape variety, ARI 516 was identified for release for cultivation in Maharashtra, Punjab, Telangana and Tamil Nadu due to its higher yield, flavor and processing qualities. It is the first grape variety to be released at the all India level through the ICAR's All India Coordinated Research Programme.

Important Highlights of Major Programmes:

- The first ever report of *ndh* gene loss in the plant genus *Capparis* L. was published by the ARI scientists. The loss of the gene indicated the impact of environmental conditions on the evolution of plants at molecular level. Further, Super DNA barcodes for the genus *Capparis* L. were proposed to facilitate the taxonomic studies/ classification of this important group of plants.
- A new methanotroph *Methylobolus aquaticusa* was reported as a part of investigation of role of methanotroph in reducing the greenhouse gas emission in rice fields.
- Pigment producing fungi were explored by ARI for the application in the textile industry.
- The anticancer potential of lichen metabolites lecanoric acid and zeorin was evaluated using human cancer cell lines: MCF-7 (breast adenocarcinoma cell line) and HepG2 (hepatocellular carcinoma cell line).
- Nano-formulations of Dendrimers were developed by ARI for the targeted delivery of anticancer agents.
- Rugosa flavonoid A (a phytochemical) and its analogs were chemically synthesized by ARI for their use in the treatment of tuberculosis and chikungunya.
- An environmental indicator and bio-economic species of organic walled foraminifera *Psammophaga simplora* was discovered from the coastal regions of Maharashtra.

Important Output Indicators:

S.No	Parameters	Output
1.	Papers in refereed journals	62
2.	Books	4
3.	Chapters in Books	7
4.	Papers in Conferences	5
5.	Number of Ph.Ds. produced	4
6.	Indian Patents filed	2
7.	Research Manpower trained (other than Ph.Ds)	18
8.	Technical Manpower trained	11
9.	B.Tech/ UG projects guided	1
10.	M.Tech/M.Sc./M.Phil projects guided	20

5.2 Aryabhata Research Institute of Observational Sciences (ARIES), Nainital

The Institute focuses on research in the areas of Astronomy, Astrophysics and Atmospheric Sciences. The Institute operates a suite of optical telescopes and advanced instruments

to study the Earth's atmosphere, Sun, Planets, Stars and Galaxies. Research at ARIES is being carried out on a variety of astrophysical sources in Galactic and Extragalactic astronomy covering both observational and theoretical aspects. The research in solar physics concentrates on the observations and modeling of transient phenomena, space weather phenomena and magneto-hydrodynamic waves in the solar atmosphere. In Atmospheric Sciences, research is focused on the lower atmospheric processes that are governing the air pollution and climate changes. Modeling and satellite data analyses are also carried out to understand the chemical, physical and dynamical processes in the atmosphere.

Major Accomplishments:

- The vanishing and appearing sources during a century of observations were studied by ARIES and follow-up observations of USNO “missing stars” in modern sky surveys were conducted.
- Using extensive data with the 1.3m Devasthal Fast Optical Telescope (DFOT), scientists trace the mystery behind dwarf galaxy aberrations of massive star formation.
- A new formula to access spectra of accretion discs around black holes was devised to estimate the black hole mass by ARIES.
- Using AstroSat data by ARIES peculiar pair of stars in a binary system found in a galactic core provide clues to evolution of unusual stars.
- The century old Solar data from the Kodaikanal Digital Archive was used by ARIES to reproduce the magnetic maps.
- Estimation of atmospheric turbulence parameters of Himalayan region was published using the data obtained with the recently operationalized ST Radar facility at ARIES.
- During June 2020 two major astronomical events were covered by ARIES - i) Occultation of Pluto on 6-June-2020 which was observed with ARIES 1.3m and 3.6m telescopes in optical and near infrared bands as a part of an international campaign.

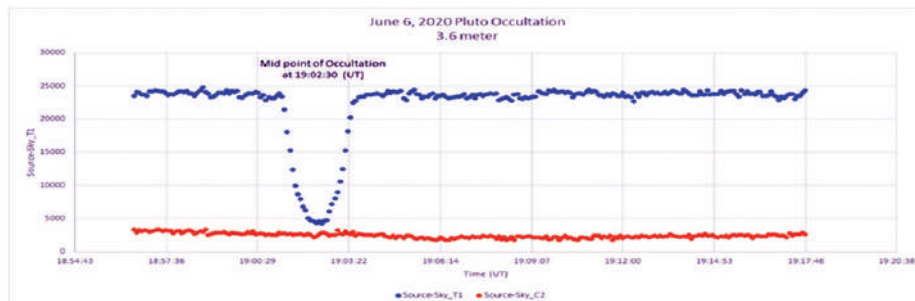

Fig. The near-infrared H-band (1.60 μm) occultation light curve of UCAC4 340-192403 being occulted by Pluto is shown in blue. The orange data points are for a reference star in the field. The dip in the brightness was about 2 mag during the occultation event.

- Annular solar eclipse on 21-June-2020 was observed with ARIES Solar telescope and telecast online with more than 1000 viewers in YouTube and FaceBook live.



Fig. Sequence of annular solar eclipse on 21-June-2020, created using multiple frames, seen from ARIES Nainital.

Important Highlights of Major Programmes:

- The two major observational facilities, 3.6m Devasthal Optical Telescope (DOT) and ST Radar, in astronomy and atmospheric sciences are operational. DOT has been released for scientific observations to the Indian and Belgian astronomical community.
- A workshops on “Investigating the Stellar Variability and Star Formation” as part of the bilateral programmes between DST, and Ministry of Science & Technology Kingdom of Thailand in the area of Astronomy and Astrophysics, was organized.

Important Output Indicators:

S.No.	Parameters	Output
1.	Papers in refereed journals	78
2.	Number of Ph.Ds. (submitted)	2
3.	B.Tech/ UG projects guided	5
4.	M.Tech/M.Sc./M.Phil projects guided	5

5.3 Birbal Sahni Institute of Palaeosciences (BSIP), Lucknow

The BSIP carries out research both on fundamental as well as applied aspects of Palaeosciences that includes evolutionary history of biota, paleoclimate, studies of past civilization, human history and contemporary climate change issues, following an integrated and multi-disciplinary approach. The research activities are: Understanding origin and evolution of life through time and space; Understanding climate change in recent and deep geological times; Understanding past civilization and human history; Application of Palaeosciences in exploration of fossil fuel and coal industry.

Major Accomplishments:

Some of the research output of BSIP are as follows:

- Siwalik leaf fossils characterises the presence modern south Asia monsoon since ~12 million years.
- Coal characterisation from the Gurha lignite mine, Rajasthan reveals that they are mainly derived from evergreen forests.
- Discovery of transitional increase in atmospheric oxygen level from 1.2 Ga sediments supported the evolution of complex eukaryotes.
- In the Ladakh-Karakoram region climate appear to be dominated by westerlies between 4000–2000 yr BP and thereafter by Indian Summer Monsoon. The record of *Didymosphenia* (diatom) and charcoal, reveals the presence of humans even at 3000 yr BP, probably connected with ‘Silk route’.
- Cenogram analysis on the Cenozoic mammalian communities across the globe reveals that the Paleogene mammals thrived in tropical to subtropical forests and Neogene mammals existed in open forests or savannah.
- The carbon isotope and pollen analysis derived from the sediments Dzukou valley of northeast India suggests weaker monsoon ~3100–2300 cal BP and high monsoon ~2300–1000 cal BP and decline in precipitation ~1000 cal BP onward. The analysis also reveals asynchronous vegetation succession in northeast India.
- Study conducted by BSIP based on dinoflagellate cysts and foraminifera on the Early Cretaceous sediments of Krishna-Godavari Basin indicates a latest Barremian-early Aptian age for the earliest marine transgression in the Krishna-Godavari Basin.

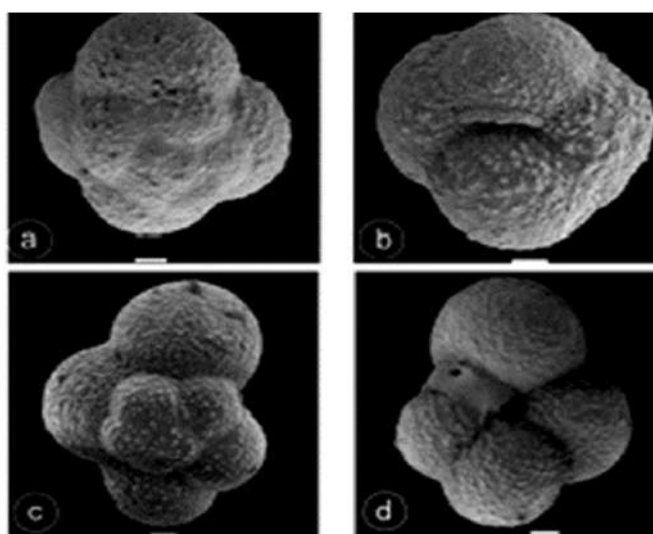

Fig. SEM photograph of selected foraminiferal taxa from DNG well of the Krishna-Godavari Basin, India, a-b *Hedbergella tardita* and c-d *Hedbergella ruka*.

Important Highlights of Major Programmes:

- In view of the worldwide COVID-19 Pandemic, the institute also extended its BSL-2A testing Laboratory into the RT-PCR based testing facility to serve the nation. The facility is functional since May 2020 and more than 1 lakh samples, which includes samples coming from different districts of Uttar Pradesh have been tested.
- Association of Quaternary Researchers (AOQR) with its headquarters at BSIP has organized a webinar series an online interaction between early career scientists under the banner Association of Quaternary Researchers (AOQR) and International Quaternary Association (INQUA) was also organized on a virtual platform.
- A three days International virtual conference on “*Earth’s Changing Climate: Past, Present & Future*” was jointly organized by BSIP and Society of Earth Scientists.

Important Output Indicators:

S.No.	Parameters	Output
1.	Papers in refereed journals	72
2.	Chapters in Books	12
3.	Papers in Conferences	34
4.	Number of Ph.Ds. produced	2
5.	Research Manpower trained (other than Ph.Ds)	8
6.	Technical Manpower trained	3
7.	M.Tech/M.Sc./M.Phil projects guided	8

5.4 Bose Institute (BI), Kolkata

Bose Institute pursues research for augmentation of fundamental knowledge-base and developing solutions to national problems in the areas of healthcare, food security, environmental pollution and climate change. Research is pursued in areas such as fundamental understanding of subatomic particles, instrumentation for experimental high energy physics, development of detectors/sensors- from cosmic rays to biomolecules and the dynamics of atmospheric pollutants, especially in the Himalayan region, stress response and disease biology.

A. Major Accomplishments: The research output for the requested period are as follows:

Biochemistry & Bioinformatics :

- Understanding the structure, function, folding-unfolding mechanism, and stability of the sigma factor, anti-sigma factor, anti-anti-sigma factor, and cyclophilin of *Staphylococcus aureus*.

- Uncovering the unique subcellular distribution of certain components of the cellular protein degradation machinery of the enteropathogen *Giardia lamblia*.
- Evaluation of plant growth promotion properties and induction of antioxidative defense mechanism by tea rhizobacteria of Darjeeling, India.
- Predicted a set of drugs repurposed against Covid 19.
- To improve diagnosis, prognosis and treatment of lung diseases like asthma/COPD and MDR-TB using bioinformatics and systems biology approaches.

Biophysics :

- BI solved the crystal structure of structure of C-terminal domain of PC4 in presence of a peptide from the C-terminal domain of p53.
- Three-dimensional solution structures of several antimicrobial peptides targeting pathogenic model membrane mimic were solved.
- Established the role of Alzheimer pathogenicity from the investigation of core amyloid forming Ab40 fragments in membrane.
- Identified a non-toxic and serum stable heptapeptide that inhibits insulin amyloid fibrillation, implicated in Type II Diabetes.
- Cultivated the transcriptional circuitry of c-Myc oncogene.

Molecular Medicine & Microbiology:

- Development of novel reaction methodologies for the synthesis of glycoconjugates and their evaluation for possible antibacterial vaccine candidates.
- Praja1 ubiquitin ligase has been identified in clearance of polyQ proteins.
- Identification of a novel pro-tumorigenic function of the ganglioside GM2, Generation of stable GM2-synthase KO cell line using genome editing technique, Identification of a novel epigenetic mechanism in the regulation of GM2-synthase transcription.
- Biochemical and molecular characterization of catabolic gene regulation in the degradation of endocrine disrupting chemicals.
- Microbial diversity and *in silico* functional metagenomic analysis of Hilsa gut microbiota.
- Study of novel bioactive compounds and polyketide synthase gene clusters from mangrove plant associated microbes by culturable and culture-independent procedures.

Physics :

- Demonstration of the tuning of light-matter coupling in exciton-plasmon (2D-0D) hybrid system. It is shown for the first time the switching between the optical emissions due to the transitions of exciton and trion in WS₂.
- Characterization of the hot and dense quark gluon plasma (QGP) medium produced in heavy ion collisions, by studying jet modifications in presence of the medium using ALICE detectors and using the framework of theoretical models EPOS and JEWEL.
- Understanding the dynamics of particle production in small systems (proton-proton collisions) at LHC energy through study of jet properties.

Plant Biology :

- Identification of genome-wide targets and DNA recognition sequence of the *Arabidopsis* HMG-box protein during the cold stress response.
- Development of low phytate rice by over-expressing *appA* gene cloned from *E. coli* under the aleurone-specific promoter of maize *zein* gene.
- Study on fungal-stress responsive mRNA and miRNA transcriptome of tomato.
- Deciphering the roles of extracellular ribonucleases Nuc1 and Nuc2 of *Ustilago maydis* in scavenging of extracellular RNA as a phosphate source.
- Understanding the extracellular defense response of rice towards infection with *Rhizoctonia solani* AG11A through apoplastic proteome study.

Environmental Sciences :

- The relative role of anthropogenic black carbon particles and natural sea-salt particles on the cloud droplet formation were studied in detail over the atmosphere of eastern Himalaya.
- The role of volatile organic compounds emitted from the Himalayan high altitude biosphere on the formation and enhancement of atmospheric particulate pollutants has been studied over eastern Himalaya under the restricted anthropogenic emissions during COVID-19 lockdown.

Important Highlights of Major Programmes:

- An atypical region in cyclophilin is crucial for maintaining its structure, function, stability, and shape.
- Thermodynamic stability of anti-anti-sigma factor and cyclophilin were increased in the presence of cognate ligands.

- The post-translational modifications of alpha-SNAP changes during encystation
- Tea PGP rhizobacteria are capable of inducing antioxidative defense mechanism in host plants.
- Identified a non-toxic and serum stable heptapeptide that inhibits insulin amyloid fibrillation, implicated in Type II Diabetes.
- BI proposed for the first time a nanotechnology-based non-coding RNA guided biosensor. This biosensor-based instrument will be a useful addition to clinical applications. This instrument will identify disease biomarkers to control infections/diseases.
- Identification of a novel mechanism involving microRNA in GM2 mediated pro-tumorigenic potential. Understanding an epigenetic regulation of ganglioside synthase gene in cancer.
- Understanding the production and properties of charged jets in proton-proton (pp) and proton-Lead (p-Pb) collisions to unfold the open question of medium formation in small systems
- A systematic study on the stability and uniformity of the gain and energy resolution of a triple GEM (Gas Electron Multiplier) and straw tube detector
- Commissioning of a small air shower array of active detectors at Darjeeling campus of Bose Institute

Important Output Indicators:

S.No.	Parameters	Output
1.	Papers in refereed journals (including 36 ALICE Collaboration publications)	119
2.	Chapters in Books	10
3.	Papers in Conferences	13
4.	Number of Ph.Ds. produced	13
5.	M.Tech/M.Sc./M.Phil projects guided	9
6.	Webinars, Talks, Presentation etc.	9
7.	Science Communication, Scientific writing etc.	2

5.5 Centre for Nano and Soft Matter Sciences (CeNS), Bengaluru

The centre focusses its R&D activities in the areas of Nano science and nanotechnology; nano-soft composites; soft matters such as liquid crystals, polymers, gels, membranes etc and its application. The research activities during the reported period are: Spent electrocatalysts; Antimicrobial face masks; Triboelectric face masks; Liquid crystals; Soft-Nano composites; Coordination polymers; Optical Metamaterials; 1D and 3D Soft Photonic systems; Liquid Crystal Gels; Triboelectric Nanogenerators; Metal-oxide nanostructures; Gas

sensors; Transparent conducting electrodes, Smart particle filters; Lead free nanocrystals for photovoltaics; Printed Electronics; Electrochemical Biosensors; Energy storage devices.

Major Accomplishments:

The research output for the reported period are as follows:

- Modification of N95 facemasks with nanoformulation coating for deactivation of microbes.
- A wide thermal range chiral nematic phase observed in cholesterol-based nonsymmetric dimers.
- A portable kit with coordination polymers for detection of explosives.
- A LC-based colloidal metamaterial exhibits tunable forward scattering utilizing the refractive index modulation of nematic phase.
- Room temperature oxygen sensors are developed by CeNS with slanted nanorod structures of TiO_2 and Cr doped TiO_2 with the aid of UV light.
- Gold decorated TiO_2/ZnO heterostructures that are highly sensitive to VOCs and selective to toluene with fast response times.
- Established that Hybrid electrodes, possessing excellent conductive property of the metal mesh (sheet resistance, ~ 5 ohms/square) with oxide surface finish, as an alternate to ITO substrates.
- Transparent and flexible EMI shields made of metal mesh coatings with remarkably high values ~ 41 dB over a wide spectral range of the Ku band (12 to 18 GHz).
- Tribo e mask, the face asks with built-in triboelectric functionality is patented and technology is transferred to Camillia Clothings Ltd. The company is marketing the face masks under the brand name of "3BO".
- Synthesis of Copper tin and copper tantalum chalcogenide nanocrystals.



Tribo e mask

- Switchable smart windows using a biopolymer network of cellulose nanocrystals imposed on a nematic liquid crystal
- Conjunctive photoluminescence enhancement through plasmonic and photonic bandgap pathways in a chiral self-assembled system
- Additive-free aqueous dispersions of inorganic graphene analogues with glial cell compatibility and enzymatic degradability
- Unveiling the effect of crystalline phases of iron oxyhydroxide for highly sensitive and selective detection of dopamine

Important Highlights of Major Programmes:

- Spent catalyst obtained from industrial waste used as a bifunctional electrocatalyst facilitating oxygen evolution and oxygen reduction reactions and thereby, can be employed for applications in zinc-air battery.
- Defective NiO by electron beam bombardment that oxidizes urea more effectively than pristine NiO.
- Antimicrobial, non-toxic face masks coated with metal oxides with spiky morphology bearing silver nanoparticles and surfactants show excellent bactericidal properties.
- Co-ordination polymers capable of sensing explosive materials and toxic metal ions in ground water.
- Evidence of tunable Fano resonance in a liquid crystal based optical metamaterial and Tunable forward scattering in a liquid crystal based optical metamaterial
- Gas sensors based on metal oxide semiconductor nanostructures sense oxygen, CO, and VOCs.
- Self-cleaning structural colors of TiO₂/Ti nanostructures with hydrophilic and hydrophobic properties.
- Resistive switching properties of metal oxides and 2D materials for ReRAM applications.
- Scalable Fabrication of scratch-Proof transparent Al/F-SnO₂ hybrid electrodes with excellent transparency, low sheet resistance, with high scratch-proof properties.
- Photoinduced transition from 1D PBG to 3D PBG structures
- Flexible, transparent, lightweight and robust triboelectric nano generator with high output lights up 11 LEDs with gentle hand tapping.

Important Output Indicators:

S.No.	Parameters	Output
1.	Papers in refereed journals	50
2.	Chapters in Books	2
3.	Papers in Conferences	2
4.	Number of Ph.Ds. produced	1
5.	Indian Patents filed	3
	Indian Patents granted	1
6.	Number of Technologies/Designs and other intellectual products commercialized	1
7.	Research Manpower trained (other than Ph.Ds)	7
8.	Technical Manpower trained	9
9.	B.Tech/ UG projects guided	8

5.6 Indian Association for the Cultivation of Science (IACS), Kolkata

The IACS pursues research on the areas of Biological Sciences, Chemical Sciences, Materials Sciences, Mathematical and Computational Sciences, Applied & Interdisciplinary Sciences and Physical Sciences are some of the major areas of R&D at the IACS.

Major Accomplishments:

- Seventeen faculty members of IACS listed in the top 2% scientists of the world based on an independent study of Stanford University scientists – (<https://journals.plos.org/plosbiology/article?id=10.1371/journal.pbio.3000918>).
- One woman faculty member from the School of Chemical Sciences has been awarded Shanti Swarup Bhatnagar Prize 2020 in Chemical Sciences.
- One faculty member initiated a Morpholino-based antisense antiviral therapy for COVID 19 under the IUSSTF program.
- One faculty member awarded Young Achiever Award 2019, Department of Atomic Energy.

Important Highlights of Major Programmes:

- Development of morpholino-based antisense therapy for the treatment of genetic disorder diseases.
- Angled-Stencil Lithography driven hybrid metal micro-mesh/Ti₃C₂TxMXene transparent conducting electrodes for portable and wearable thermotherapy.

- Dynamic generation of G-quadruplex DNA ligands by target guided combinatorial chemistry on a magnetic nano platform

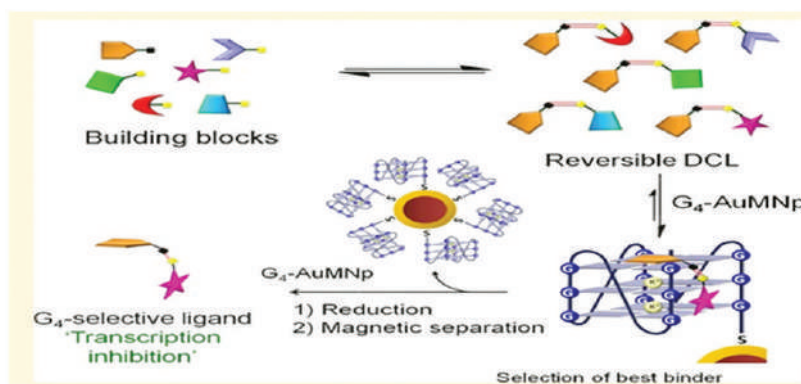

Fig. Dynamic generation of G-quadruplex DNA ligands

- Rapid and Low-temperature synthesis of facet oriented double perovskite microcrystals for high-performance photodetector applications.
- Development of the SFG spectrometer and its application to understand the molecular processes behind the neurodegenerative diseases.
- Cloning of SARS-COV2-RNA dependent RNA polymerase for recombinant protein purification.
- A new item was published on Chemical Bonding on C2. Novel periodic mesoporous organosilica materials has been designed which showed activity for the adsorptive removal of Hg(II) from contaminated ground water.
- Fabrication of nc-Si solar cells on low-cost flexible substrates are in the major program.
- Face masks Aerosol filtration efficiency measurement setup for the detection of Covid-19 spread.
- Bespoke test set-up for the direct measurement of electro-caloric temperature change in ferroelectric materials.
- A new animal and zebra fish house developed to boost to biological research.
- A start-up grant was sanctioned from Biotechnology Industry Research Assistance Council (BIRAC), DBT, for the development of point-of-care device for the selective detection of human serum albumin, creatine kinase and kidney injury molecule-I for the accurate determination of acute kidney injury.
- BIRAC-DBT has funded the formation of a start-up company, GR Agritek Labs through Biotechnology Ignition Grant-13 involving scientists from IACS.

- A private industry sponsored research program was initiated with ATGC Biotech Pvt. Ltd. for the development of semiochemical loaded organogelators for the management of certain agricultural pests.

Important Output Indicators:

S.No	Parameters	Output
1.	Papers in refereed journals	362
2.	Books	04
3.	Chapters in Books	11
4.	Papers in Conferences	13
5.	Number of Ph.Ds. produced	42
6.	Foreign Patents filed	02
	Foreign Patents granted	01
7.	Indian Patents filed	07
8.	Number of Technologies/Designs and other intellectual products commercialized	01
9.	Research Manpower trained (other than Ph.Ds)	174
10.	B.Tech/ UG projects guided	19
11.	M.Tech/M.Sc./M.Phil projects guided	36

5.7 Indian Institute of Astrophysics (IIA), Bengaluru

IIA focusses its Research and development on Astronomy and Astrophysics, Atomic Physics, Laser Physics and Astronomical Instrumentation development of facilities.

Major Accomplishments:

- Institute is completing 50 years since its inception in 1971 and the endeavor to carry out research in the fields related to Astronomy & Astrophysics and to create and maintain excellent observing facilities is continuing.
- One of the flagship projects of IIA, the Himalayan Chandra Telescope (HCT), installed at Hanle, Leh completed 20 years of its operation catering to the Indian and International astronomical community with quality data to conduct frontline research.
- Ultraviolet Imaging Telescope (UVIT) onboard India's first space observatory, ASTRO-SAT, which was built by IIA in lead and launched in 2015 September has also completed its 5 years of operation.
- UVIT is producing new and very interesting results, for example, using data from the UVIT, IIA scientists have detected low- and extremely low mass White Dwarf (WD) companions to WDs that form post-mass transfer systems, highlighting the importance of UV

observations in the detection and characterization of such systems.

- In a work published in the reputed *Nature Astronomy* journal, IIA scientists have demonstrated that all red clump stars have high levels of Lithium for their evolutionary stage, with an increase of a factor of 40 over the end of the red giant branch stage something not predicted by stellar theory, hence posing a challenge to our understanding of stellar evolution.

Important Highlights of Major Programmes:

- IIA is actively engaged in several national and international programmes like the Thirty Meter Telescope (TMT), Aditya-L1, Maunakea Spectroscopic Explorer, National Large Solar Telescope, and a next generation Ultraviolet space mission.
- The optics for the Visible Emission Line Coronagraph (VELC), the most important payload onboard India's solar space mission Aditya-L1, are under tests and calibration at the Prof. MGK Menon Laboratory for Space Sciences in CREST campus. Realization of optical bench for VELC has also been successfully completed by IIA at the facility. Several optics have been integrated into their respective opto-mechanical systems and have undergone environmental tests. A web-based VELC observation proposal submission platform has also been developed.
- As a follow-up to the successful UVIT, IIA in collaboration with national and international partners, working on a proposed 1-metre class UV-Optical Indian Spectroscopic and Imaging Space Telescope (INSIST). The project completed the conceptual design as well as the preliminary design phases and is currently into final design phase.

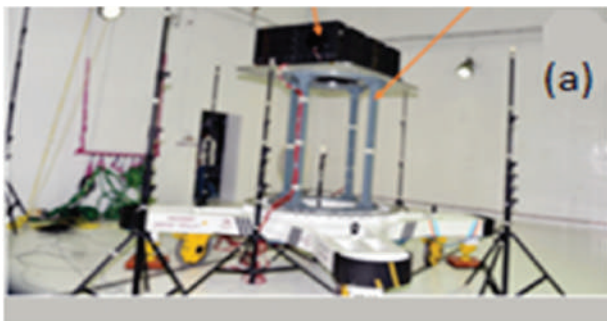

The VELC Lab Model at the ISRO Satellite Integration and Testing Establishment (ISITE) Acoustic Vibration Chamber

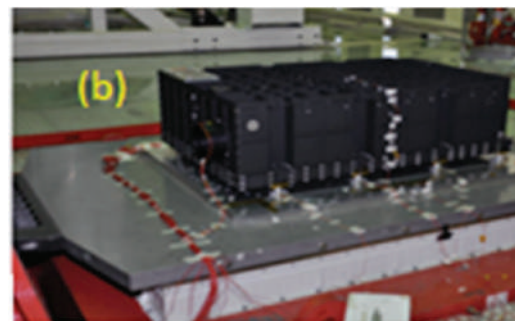

The VELC Mass Model (Mass & Inertia simulation) on 29 Ton Shaker.

Important Output Indicators:

S.No.	Parameters	Output
1.	Papers in refereed journals	107
2.	Papers in Conferences	17

S.No.	Parameters	Output
3.	Number of Ph.Ds. produced	9
4.	Research Manpower trained (other than Ph.Ds)	2
5.	B.Tech/ UG projects guided	4
6.	M.Tech/M.Sc./M.Phil projects guided	26
7.	Contribution to other DST facilities	1

5.8 Indian Institute of Geomagnetism (IIG), New Mumbai

The Institute focuses on the area of Geomagnetism and Allied Fields.

Major Accomplishments:

- Constraining the 3D acoustic ray tracing model a novel method is developed by IIG to estimate the detection altitudes of GPS-TEC derived coseismic ionospheric perturbations. This method has been further upgraded to identify the distinct seismic sources that evolved along an extended rupture varying simultaneously in space and time akin to the seismic rupture of the Mw 9.0 March 11 2011, Tohoku-Oki earthquake. Simulated tsunami water excitation over the fault region formed the base for the analysis. This novel approach allowed viewing the first 60 seconds of the Tohoku-Oki seismic source from the ionosphere to envisage the evolution of crustal deformation in space and time along the rupture and thus the segmentation of an extended seismic source and also to derive reasonably precise reflection of seismic rupture extent in the ionosphere in stipulated time.
- The geomagnetic storm of 25–26 August 2018, produced several unusual and strong effects in the electrodynamics, ionosphere, and thermosphere that became apparent in particular in the American to East Pacific region. Unprecedented hemispheric asymmetries have been observed in the thermosphere and ionosphere during the main and the recovery phases of the storm in the American and East Pacific sectors. Analysis conducted by IIG showed that in each case the asymmetry was produced by a unique combination of drivers that acted at particular moment of time and in particular place. IIG demonstrated, how chaotic and unpredictable can be the evolution of an ionospheric storm, and how a very peculiar combination of drivers can lead to extraordinary effects in the thermosphere and ionosphere.
- The study of ionosphere by recording the radio beacons from orbiting or geostationary satellites over Ahmedabad, Gujarat in the past five decades are reviewed by IIG. Results presented include both the total electron content of the ionosphere and the radio wave scintillation in the low latitudes, covering the region from the magnetic equator to beyond the ionization anomaly crest.
- Scientist of IIG estimated the gravity and pressure gradient currents, using altitude profiles of electron density obtained from the Constellation Observing System for Meteorology,

Ionosphere, and Climate (COSMIC) ₹1 satellite cluster. The magnetic variations due to these currents are estimated at different heights, latitudes, solar fluxes, and local times.

Important Highlights of Major Programmes:

- Anisotropy of Magnetic Susceptibility (AMS) data from the rocks of Almora crystalline in the vicinity of Rameshwar studied by IIG. The study integrates field, microstructural and Anisotropy of Magnetic Susceptibility (AMS) studies. Field foliation strike shows NW-SE orientation with moderate to high dip in rocks of Almora Crystalline, whereas near North Almora Thrust rocks of Almora Crystalline are steeply dipping and litho-units are intensely mylonitized due to NE-SW regional compression. The magnetic foliations are recorded to be parallel to the field foliation of the study area. Variation in orientation of magnetic lineation is inferred to imply superposed deformation in the study area. AMS study also reveals that the shape of susceptibility ellipsoid is oblate which is inferred to be due to compression.
- The evolution of ion acoustic solitary waves (IASWs) in pulsar wind was studied by IIG. The pulsar wind is modelled by considering weakly relativistic unmagnetized collisionless plasma comprised of relativistic ions and superthermal electrons and positrons. Through fluid simulations, IIG demonstrated that the localized ion density perturbations generated in the polar wind plasma can evolve the relativistic IASW pulses. It is found that the concentration of positrons, relativistic factor, superthermality of electrons, and positrons have a significant influence on the dynamical evolution of IASW pulses. Results may provide insight to understand the evolution of IASW pulses and their role in astrophysical plasmas, especially in the relativistic pulsar winds with supernova outflow, which is responsible for the production of superthermal particles and relativistic ions.
- A research was also carried out by IIG to understand the motion of the charged particles trapped in the Earth's inner magnetosphere. The emphasis is on identifying the numerical scheme, which is appropriate to characterize the trajectories of the charged particles of different energies that enter the Earth's magnetosphere and get trap along the magnetic field lines. These particles perform three different periodic motions, namely: gyration, bounce, and azimuthal drift. However, often, the gyration of the particle is ignored, and only the guiding center of the particle is traced to reduce the computational time. It is because the simulation of all three motions (gyro, bounce, and drift) together needed a robust numerical scheme, which has less numerical dissipation. A three-dimensional test particle simulation model is developed in which the relativistic equation of motion is solved numerically using the fourth and sixth-order Runge-Kutta methods. The simulation results of bounce and drift periods are in agreement with theory.
- In the Earth's inner magnetosphere, there exist regions like plasmasphere, ring current, and radiation belts, where the population of charged particles trapped along the magnetic field lines is more. These particles keep performing gyration, bounce and drift motions

until they enter the loss cone and get precipitated to the Earth's ionosphere. A three-dimensional test particle simulation model with higher accuracy is developed to study the motion of the charged particles trapped in the Earth's inner magnetosphere. This high precision simulation model demonstrates that the existing theoretical model sometimes overestimates or underestimates the magnetic mirror point latitude depending on the value of L-shell, energy, and gyro-phase due to underlying guiding center approximation. The theoretical expression for the magnetic mirror point of the charged particle is often used to understand their penetration depth in the ionosphere. In this context, the new simulation-based model developed by IIG will be useful to the scientific community to understand the dynamics of the trapped particles in the Earth's inner magnetosphere.

- The Killari Earthquake (Mw 6.1) of September 30, 1993, occurred in Maharashtra, India. The anisotropy of magnetic susceptibility study was performed by IIG on sedimentary core samples located in the upper to lower stream of the Tirna River basin, in order to evaluate the effects of earthquake on the river flow dynamics.

Important Output Indicators

S. No.	Parameters	Output
1.	Papers in refereed journals	76
2.	Chapters in Books	02
3.	Papers in Conferences	16
4.	Number of Ph.Ds. produced	06
5.	Indian Patents filed	01
6.	M.Tech/M.Sc./M.Phil projects guided	06
7.	Scientific Outreach Programmes organized	07
8.	Popular Science Articles published	38
9.	Number of persons who attended various science outreach programmes/ conferences etc.	5300
10.	Scientific Lectures/Training Programmes organized	22
11.	Number of students trained	150
12.	Number of school/college/university teachers trained	225

5.9 Institute of Advanced Study in Science and Technology (IASST), Guwahati

The institute focuses on five research programs viz., (i) Basic and Applied Plasma Physics, (ii) Advanced Material Sciences, (iii) Mathematical and Computational Sciences, (iv) Biodiversity and Ecosystem Restoration Programme and (v) Traditional knowledge based drug discovery.

Major Accomplishments:

- Characterized Cypovirus and its function to understand pathogenesis to Muga silkworm.

- Developed a non-toxic, environment friendly Titanium dioxide nanoparticle-based formulation to boost immune system of Muga silkworm against cypovirus.
- Synthesized Tungsten trioxide (WO_3-x) with tunable band gap in an in-liquid plasma reactor.
- Ionospheric plasma interaction with a solid surface Investigated in a laboratory device.
- Developed Atmospheric pressure plasma for surface modification and biomedical applications.
- Designing of a linear magnetized plasma device carried out for investigation in magnetized plasma by IASST.
- Developed Actinobacteria mediated synthesis of bio-conjugate of carbon dot with enhanced biological activity and fabricated a Palmitic acid-carbon dot hybrid vesicles for toxin removal.
- Synthesis of crystalline rubrene film in one-step plasma process and realization of a pyro-phototronic device where surface-layer polarization results in pyro-phototronic effect. A patent has been filed.
- Developed high-responsive ultrafast UV-photodetector where pyro-phototronic effect and inter-band transition contributes in the charge carrier generation.
- Unreliable queueing model where the server is not available is analyzed under various stochastic features by IASST.
- IASST developed AI-driven tools for full segmentation and classification of several cancer types. These types, along with the type of diagnosis used are cervix (Papsmear with LBC technology), Oral (Biopsy), Childhood brain cancer (Biopsy), Breast (Mammogram) etc.
- AI-driven segmentation of 5.56 and 9 mm bullets (firearm) was also developed.

Important Highlights of Major Programs:

- Void formation and vortex generation has been reported for the first time in flowing dusty plasma. Atmospheric pressure plasma reactors with RF/DC/AC discharge in gas phase and in liquid media was developed for nanomaterial synthesis and biomedical applications.
- Designing a linear magnetized plasma device has been carried out by IASST for investigation in magnetized plasma, important in both fusion plasma and astrophysics. The vacuum chamber has been fabricated.
- In the field of organic thin films: (a) Formation of compact protein layers on hydrophilic

silicon surface was achieved and Collapse nature of organic monolayer follows the 2D percolation model were studied.

- In the field of nano science: (a) Growth nature of nanocrystals below the organic monolayer is explored. (b) pH-dependent reversible optical emission behaviour of fluorescent copper nanoclusters studied.
- For the first time a DNA-carbon dots based electrochemical biosensor for sensitive and selective detection of mutagenic nitrosamines like NDMA and NDEA were studied.
- An anti-diabetic enriched fraction with marker compounds (Verbascoside and Isoverbascoside) have been developed.
- Methods for preparation of therapeutically active protopine enriched extract effecting modulation of blood glucose and conditions associated therewith which efficiently prevents hyperglycaemia.
- IASST with DBT, GoI has established a quality control/quality assurance laboratory (QAQC) for testing herbal and medicinal plant material/extract.
- Demonstrated pH responsive smart drug delivery system. A hybrid cotton patch nanocomposite incorporated with jute carbon dots fabricated for the drug release was studied. Jute was used for the first time as a precursor in synthesizing fluorescent carbon dots, water was used as the dispersion medium and neem leaf extract as model drug to exemplify the release study



Hybrid cotton patch nanocomposite incorporated with jute carbon dots fabricated for the drug release

Important Output Indicators:

S.No.	Parameters	Output
1.	Papers in refereed journals	77
2.	Chapters in Books	10
3.	Papers in Conferences	40
4.	Number of Ph.Ds. produced	8
5.	Indian Patents filed	7
6.	Indian Patents granted	2
7.	Number of Technology leads awaiting transfer	6
8.	Research Manpower trained (other than Ph.Ds)	17
9.	Technical Manpower trained	15

S.No.	Parameters	Output
10.	B.Tech/ UG projects guided	14
11.	M.Tech/M.Sc./M.Phil projects guided	14
12.	Extramural Project	25

5.10 Institute of Nano Science and Technology (INST), Mohali

Research and academic activities of Institute of Nano Science and Technology (INST), Mohali (Punjab) has major thrust on the following areas: Electrochemical devices for Energy Conversion and Storage, Smart materials for packaging, Ultrafast Spectroscopy and its Applications, Topological materials for future devices, Topological materials, Nanotechnology based technology in Agricultural and Food technology, Nanotoxicology, Biomechanics for understanding human disease and development of smart biomaterials, Theranostics for point of care and Nanomaterials from natural sources.

Major Accomplishments :

- A novel nano carrier to control epigenetic regulator polycomb protein Bmi1 targeted acute myeloid leukemia (AML) nanotherapy was developed by INST.
- INST designed heterostructured materials for spintronics and quantum devices based on Quantum and relativistic effects in 2d-electron gas. In addition, the possibilities of storing volatile as well as non-volatile memory on oxide materials was demonstrated.
- Surface-Enhanced Raman Hotspots (SERS) Engineering was demonstrated by INST on artificial edges on the 2D MoS₂ atomic sheets.
- Demonstrated Zn based Metal Organic Nanotube (MONT), for detecting nicotine from cigarette smoke at room temperature with a very low detection limit of ~ 23.3 μ M.
- Studied the case of Nanoparticles with chitosan and loaded these nanoparticles with zinc gluconate for reducing the severity of rheumatoid arthritis.
- Nanorods from the nonsteroidal anti-inflammatory drug (NSAID) Aspirin was explored and demonstrated its potential as an effective non-invasive small molecule based nanotherapeutics against cataract.

Important Highlights of Major Programmes:

- INST offers PhD and postdoctoral fellowships to students as part of its mandate to develop skilled human resources. Presently, 166 students are pursuing their PhD at INST.
- INST, Mohali conducted a programme for candidates belonging to Scheduled Tribe (ST) to bring them in main research areas highly motivated and bright Scheduled Tribe (ST) candidates for engagement of Research Internship in various research projects in the field of Nanoscience and Nanotechnology.

- INST has covered 24 school/colleges covering 3131 students (1029 ST students, 33%) across the country through its outreach program for rural, remote and under-served schools.

Important Output Indicators:

S.No.	Parameters	Output
1.	Papers in refereed journals	149
2.	Chapters in Books	01
3.	Number of Ph.Ds. produced	13
4.	Indian Patents granted	01
5.	Number of Technology leads awaiting transfer	03
6.	Technical Manpower trained	03
7.	B.Tech/ UG projects guided	8

5.11 International Advanced Research Centre for Powder Metallurgy and New Materials (ARCI), Hyderabad

The institute focuses its research on the areas of Automotive Energy Materials, Solar Energy Materials, Nanomaterials, Engineered Coatings, Ceramic Processing, Laser Processing of Materials, Fuel Cells, Carbon Materials.

Major Accomplishments:

- UC-C based disinfection devices to fight against Corona Pandemic and to contain its spread were developed and deployed in collaboration with industrial partners by ARCI. They include
 - Ultra-Violet-C (UVC) based disinfectant trolley (Safe Trolley) for rapid disinfection of hospital environments.
 - UVC based Disinfection Cabinets, Safe Box and Safe Blade for disinfection of domestic articles such as cloths, laptops, cell phones, jewelry, watches etc; and
 - UVC based Baggage Disinfection System (KritiScan® UV) for airports, railway, hotels, commercial and private establishments for rapid disinfection of baggage.



UVC Trolley for disinfection of Hospitals



UV-C Disinfection Cabinets



KriScan® UV – Baggage Disinfection System

- ARCI Developed and demonstrated hypochlorous acid (HOCl)-based fogging units ('Sanitising Chambers') for disinfecting the medical personnel wearing PPE kits and humans in partnership with DRDL, ESIC Medical College and Hospital, Hyderabad and Saffrongrid Limited, Hyderabad.
- ARCI agreements signed with various companies for Know-how/ technology transfer of a) Synthesis of electro-catalysts for use in PEM Fuel cells and b) Easy-to-clean coating technology for Solar PV applications



Easy to Clean Coatings on Glass

- Laser clad deposition technology was demonstrated by ARCI for a) repair of aerospace components and b) thermal power plant components for improving their life,
- Biofilm inhibiting coatings, developed by sol-gel method at ARCI, exhibited 60-90% biofilm inhibition for different bacteria when applied on surgical sutures made of nylon, silk, acrylic material; contact eye-lens cases and glass substrates
- ARCI Developed Advanced Detonation spray coating system having enhanced productivity and efficiency.

- Scrub pads, generated by a collaborating company using ARCI developed antibacterial powder, exhibited >95% antibacterial activity.
- ARCI Synthesized at lab-scale non-aqueous electrolyte for sodium ion battery with ionic conductivity $\sim 10^{-2}$ S/cm that is on par with commercial lithium based electrolyte.
- Several applications/components such as Microchannel disc, Valve block, Brackets, Gearbox and Biometric cover for Pen drive were developed using laser-based additive manufacturing at ARCI.
- Wear resistant surface coatings (TiCrN +DLC) were developed on minting dies. These coated dies exhibited 2.5 times life enhancement when compared to the bare dies.

Important Highlights of Major Programmes:

- A Supercapacitor fabrication line was established by ARCI and super-capacitors of 1200 F capacitance developed using indigenously developed porous carbon derived from petroleum waste.



Indigenous developed 1200F Supercapacitor using activated carbon derived from petroleum coke waste

- ARCI scaled up melting of Fe-P alloy in collaboration with MIDHANI for development of prototype alternators used in automotive industry,
- A 5kW PEMFC system consisting of stack and BOP components (for thermal management) commissioned at BARC, Mumbai for integration with their electrolyzer for conversion of fuel value of hydrogen to electricity; 1kW PEMFC stack was evaluated by an external source (IOCL, Faridabad) for durability testing, and results are in line with in-house evaluation results.
- The feasibility of laser and laser-arc hybrid welding of thick sections for power plant applications in plate-plate and plate-tube configurations has been developed;

- Established the process for manufacture of ODS-Fe₃Al rods that exhibit good combination of strength and ductility at room temperature as well as at high temperatures.
- First of its kind thermal spray facilities, such as Axial Plasma Spray and High Velocity Air Fuel Spray, was established:

Important Output Indicators:

S.No.	Parameters	Output
1.	Papers in refereed (SCI) publications	103
2.	Books & Chapters in Books	17
3.	Papers in Conferences (with or without proceeding)	35
4.	Number of Ph.Ds. produced (including employees and Fellows)	4
5.	Foreign Patents filed	3
	Foreign Patents granted	0
6.	Indian Patents filed	10
	Indian Patents granted	20
7.	Number of Technologies Transferred/applications developed/products supplied#	15
8.	Number of Technology leads awaiting transfer#	31
9.	Research Manpower trained (other than Ph.Ds)	24
10.	Technical Manpower trained	18
11.	B.Tech/ M.Sc projects guided	14
12.	M.Tech/ projects guided	13
13.	Number of Fellows Pursuing Ph.D	47
14.	Number of Project Scientists Pursuing Ph.D	15

5.12 Jawaharlal Nehru Centre for Advanced Scientific Research (JNCASR), Bengaluru

The Centre focuses its research on Biology, Geodynamics, Molecular Biology and Genetics, Neurosciences, Theoretical Sciences, and New Chemistry.

Major Accomplishment:

- In Nature Index Annual Tables 2020, the Centre ranked 4th among Indian academic institutions in the domain of life science and stands 10th in chemistry and physical sciences, respectively. JNCASR global ranking stands at 469th, 11th among Indian institutions in the tally.
- Research team from JNCASR along with researchers from IISc and IIT-Bombay, and with the help of AFMS and the Principal Scientific Advisor (PSA) to GoI, developed a

mathematical model that can predict the evolution of the COVID-19 situation for few weeks, along with the medical needs that will arise as a consequence. It can enable decision makers to make informed choices that will greatly contribute to controlling the situation. These predictions can be seen at the website <https://covid19medinventory.in>

- A research group in JNCASR developed an antimicrobial coating that kills influenza virus as well as resistant pathogenic bacteria (e.g. methicillin-resistant *Staphylococcus aureus*) and fungi (e.g. fluconazole-resistant *C. albicans*). It can be used to coat different PPEs, thereby becoming extremely beneficial to healthcare professionals fighting COVID-19. The team also developed another novel molecule by chemically linking an amino acid (glycine) to a polymer; this molecule was found to possess high antibacterial activity against multidrug-resistant *Acinetobacter baumannii*, while showing no toxicity to human cells.
- A team of researchers from JNCASR modified berberine to Ber-D, which is soluble and exhibits antioxidant properties. It not only prevents oxidative and biomolecular damage but also inhibits toxic A β fibrillar aggregation and protects from mitochondria dysfunction, which are the major causes of neuronal death during Alzheimer's disease (AD).
- Interpreting earthquakes Identifying the causative parameters of earthquakes and predicting when they are likely to happen next is very difficult. A study by the team of geologists from JNCASR revealed that the long-elapsing time of 600-700 years implies an enormous stacking up of strain in the Himalayan region.
- A research team from JNCASR fabricated a gold-silicon interface that shows high sensitivity towards light, allowing it to detect weak scattered light as an indication of intrusions or unwanted activity. The wafer-scale photo detector is economical, energy-efficient, and shows a rapid response, making it suitable for security applications. It can be used as a prototype imaging system and lux and power meter.
- A research group from JNCASR also developed the silk fibroin (SF) formulation using biocompatible additives and prepared an injectable SF hydrogel (iSFH) that can ease insulin delivery in diabetic patients.
- JNCASR developed a device for long-term monitoring of cells and tissues and study of drug delivery effects, tissue repair and regeneration.
- Scientist of JNCASR observed that elephant calves pick up their right or left-sided preference for trunk usage so early in life that this trait could be innate in them. This is analogous to humans showing distinct dextral or sinistral behaviour soon after birth.

Important Highlights of Major Programmes:

- A total of 60 students joined different degree programmes at the Centre. The current student strength of the Centre is 341.

- A three-day workshop was conducted at the school Chandan, Laxmeshwar. Over 700 students, 25 teachers, guests, and volunteers participated in the event.
- Parikrma Festival of Science was conducted on the theme '*Marine Life*'. Over 200 students, 50 teachers, 10 guests, and 15 volunteers participated.
- Two online interactive programmes in Physics and one in Chemistry were organized. Around 1340 students and 154 teachers participated in the programmes.
- An agreement was signed between JNCASR and Breathe Applied Sciences Pvt. Ltd., a start-up company incubated at JNCASR for transfer of technology based on lab-scale research on reducing CO₂ to methanol and other useful chemicals and fuels.
- JNCASR has established a state-of-the-art COVID Diagnostic Training Centre at its Jakkur campus to help build capacity for COVID 19 testing. It has embarked upon a campaign to train personnel in real-time PCR for COVID-19 diagnostic testing.
- VNIR Biotechnologies Private Ltd., a spin-off by JNCASR, launched indigenous fluorescent molecular probes and polymerase chain reaction (PCR) mix as part of COVID-19 test kits for carrying out reverse transcription-PCR (RT-PCR)-based detection assays. With this new launch, the test kits will become indigenously developed for the molecular probes, and will ease the process of COVID-19 testing.

Important Output Indicators:

S.No.	Parameters	Output
1.	Papers in refereed journals	250
2.	Books	2
3.	Chapters in Books	1
4.	Papers in Conferences	5
5.	Number of Ph.Ds. produced	35
6.	Foreign Patents filed	4
	Foreign Patents granted	6
7.	Indian Patents filed	9
	Indian Patents granted	7
8.	Number of Technologies/Designs and other intellectual products commercialized	5
9.	Number of Technology leads awaiting transfer	15
10.	Research Manpower trained (other than Ph.Ds)	137
11.	Technical Manpower trained	3

5.13 Raman Research Institute (RRI), Bengaluru

The institute focuses research on Astronomy & Astrophysics, Light & Matter Physics, Soft Condensed Matter and Theoretical Physics.

Major Accomplishments:

- Broadband spectral-timing analysis of a high mass X-ray binary (SMC X-1) of its super-orbital variation by RRI X-ray astronomers and collaborators from the Massachusetts Institute of Technology, USA and Max Planck Institute for Extraterrestrial Physics, Germany has led to the suggestion that the super-orbital modulation is not caused by absorption in precessing warped accretion disc alone but also due to intrinsic changes in X-rays emanating from the neutron star at different super-orbital states.
- Researchers at RRI along with collaborators from University of Rennes, France, have proposed and demonstrated a new technique for demodulation-imaging – FAST-QUAD (Full-field All-optical Single-shot Technique for Quadrature Demodulation). This technique is performed optically, rather than electronically and speeds up the process significantly, and full demodulated images are obtained instantaneously upon recording a single frame using an ordinary digital camera. This has obvious applications in navigation, defence and search and rescue.
- Studies of a particular type of spider silk using a Micro-Extension Rheometer - a device conceived, designed and built at RRI has revealed that silk fibers accommodate low values of applied strain by deforming relatively easily (softening) while they stiffen at higher values.
- Theorists at the Institute along with collaborators from C R Rao Advanced Institute of Mathematics, Statistics and Computer Science, Hyderabad, have devised a new test for fairness of quantum coin or 'qubit' (the basic unit of information in a quantum computer) using entanglement theory. This strategy has been demonstrated on the simulation facility of IBM's quantum computers.

Important Highlights of Major Programmes:

- An X-ray polarimeter, POLIX, made at RRI will be key payload on a dedicated satellite of ISRO named XPoSAt. The design, development, fabrication and testing of electronics components of POLIX were completed for a laboratory model and a space Qualification Model. For the Flight Model of POLIX the PCBs were fabricated and all components of the Flight Model detectors have been fabricated and made ready for assembly.
- Under the "Quantum Enabled Science and Technology" programme an experiment which was realised and established at the Quantum Information and Computing Laboratory (QuIC) lab, demonstrates a novel quantum state estimation tool, which RRI call Quantum

State Interferography. This technique provides tremendous scaling as well as resource gain over the conventional approaches and opens a new paradigm in quantum state estimation with immediate benefits in quantum computing, quantum communication and other quantum technologies.

Important Output Indicators:

S.No.	Parameters	Output
1.	Papers in refereed journals	110
2.	Papers in Conferences	04
3.	Number of Ph.Ds. produced	13
4.	Indian Patents granted	02
5.	Research Manpower trained (other than Ph.Ds)	27
6.	Technical Manpower trained	23

5.14 Sree Chitra Tirunal Institute for Medical Sciences and Technology (SCTIMST), Trivandrum

The research areas of the Institutes focuses on Biomaterials Research and Development, Biomedical Product Development, Technology Transfer and Industrial Linkages, Quality Management Systems, Testing and Technical Services, Research in cardiac and neurosciences, and Patient Care and Public Health.

Major Accomplishments:

- Setting up of Molecular Genetics and Neuroimmunology Unit at SCTIMST

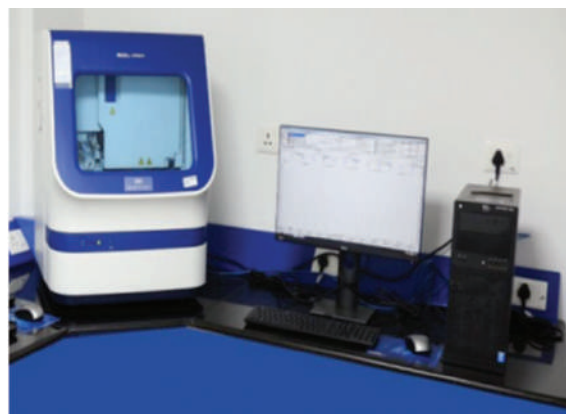

Fig. Pictures of Illumina NextSeq 550 (E) Sanger sequencer- ABI Genetic Analyzer 3500 facilitated in the Molecular Genetics and Neuroimmunology Unit.

- A new In-vivo evaluation facility for animal studies was set up to augment work on large experimental animals, which is the backbone of medical device development of Bio Medical Technology Wing, SCTIMST

- The ICMR-approved COVID-19 testing Facility by RT-PCR was set up in March 2020 by the Departments of Microbiology and Biochemistry, SCTIMST The Laboratory was selected as Mentor Institute for SARS CoV-2 testing for Kerala, Lakshadweep, and Andaman and Nicobar.

Important Highlights for Major Programs:

- Indigenous affordable stent graft and its delivery system developed by SCTIMST for the treatment of Thoracic Aortic Aneurysm (TAA). Six Patent applications and five design registrations filed for this innovation.
- Technology of External Pneumatic Compression Device and Blood Flow Meter transferred to M/s. enProductsPvt. Ltd., Cochin for commercialization.



Fig. External Pneumatic Compression Device

- Nitinol based Occlusion device for Non-surgical closure of Atrial Septal Defect (ASD).
- Development of an innovative intracranial flow diverter stent for the treatment of aneurysms of the blood vessels of the brain
- Manufacturing license is obtained for Onyx Medicals Pvt. Ltd for manufacturing two products transferred by the institute (Beta Tricalcium Phosphate and 60% synthetic Hydroxyapatite and 40% Beta Tricalcium Phosphate)
- Single centric clinical trials approval is obtained from DCGI for Rapid diagnostic kit with antibiogram for urinary tract infections.
- The Oralscan product of TIMed incubatee M/s Sascan Meditech was launched on 28th Oct 2020.



Fig. Oral cancer screening tool

- Wipro3D Chitra Emergency Breathing Assist System (EBAS) intended to use in patients with moderate to severe breathing difficulty while awaiting for mechanical ventilation was commercialized.
- TIMed prayasees supported by NIDHI Prayas grant of DST launched Powered Air Purifying Respirator and Non Contact Thermal Scanner for COVID 19 under fast track call.
- SCTIMST has signed an MoU with M/s. Tynor Orthotics Private Limited (Tynor), Mohali to set up an Orthotics and Rehabilitation R&D vertical to promote indigenous device development. Tynor will collaborate with SCTIMST for the co-development of Orthotic devices and to promote joint research programs in Orthotics and Rehab. The main objective of this Institute-Industry collaboration is to develop a cluster of orthoses for catering to clinical conditions such as osteoarthritis and diabetic foot ulcer.



The development and commercialization of other major technologies include Chitra Acrylosorb, Viral Transport Medium, Oropharyngeal and nasopharyngeal swabs, Rapid SARS-CoV-2 antibody test kits, End-point and Realtime LAMP test using Chitra GeneLAMP-N kit, Chitra Magna-RNA isolation kit, deployable modular hospital, MEDICAB (with Modulus, an IIT Madras-based start-up), isolation pods for transferring infected patients, and single and double-chamber swab collection booth, Disinfection Gateways etc.



(AcryloSorb)

Important Output Indicators:

Sl.No	Parameters	Output
1.	Papers in refereed journals	290
2.	Chapters in Books	7
3.	Papers in Conferences	93
4.	Number of Ph.Ds. produced	15
5.	Foreign Patents filed	16
	Foreign Patents granted	01
6.	Indian Patents filed	50
	Indian Patents granted	06
7.	Number of Technologies/Designs and other intellectual products commercialized	9
8.	Number of Technology leads awaiting transfer	16
9.	Design registrations & Trademark Registrations	14
10.	Research Manpower trained (other than Ph.Ds)	582
11.	Technical Manpower trained	90
12.	M.Tech/M.Sc./M.Phil projects guided	07

5.15 S N Bose National Centre for Basic Sciences, Kolkata

Areas of focus of the Centre are Physics of nanomaterials including application-specific materials and nanodevices; Advanced computational materials science including soft condensed matter, ionic liquids and biomolecules; Interface of biology and condensed matter physics : DNA-protein and nanomaterials interactions, biomolecular recognition and application of ultrafast spectroscopy in; Collective behavior in quantum and classical condensed state including driven systems, ultra cold quantum gases and spin transport through Quantum wires; Theoretical work on black holes and its cosmological consequences and astro-chemistry. Selected problems in Quantum field theory, Statistical Physics and Non-Linear Dynamics etc.

Major Accomplishment:

- The Centre ranks among top three DST institutes and top 30 Indian institutes as per Nature Index ranking based on quality research publications in the year 2019.
- The Centre has developed a new-generation non-invasive diagnostic strategy that can help physicians in early and quick diagnosis of Helicobacter pylori infection in the stomach through breath analysis.
- The S N Bose Centre has invented the Photostable, all inorganic perovskites that could pave the way for a low cost and efficient PV cells.
- The S N Bose Centre has developed reprogrammable and reconfigurable spin-wave nanochannels, which may pave way to develop next generation all-magnetic computers.
- The Centre has explored the isotope-selective water- metabolism in human body and has found a new “Breathprint” for the gastric pathogen in stomach using breathomics approach.

Important Highlights of Major Programme:

- SNBNCBS has transferred of following three (03) Technologies developed under the TRC project to different Indian Companies.
 - (i) A Non-invasive Hyperbilirubinemia Screening System for Neonatals - Zyna Med- Tech, Visakhapattanam.
 - (ii) Respirator with Attached Exhalation Valve and Suspended Particulate Matter Filter for Comfortable and Hygienic Breathing - Paulmech Infrastructure Pvt. Ltd., Kolkata
 - (iii) A Nano-sanitizer with a Dispensing Antimicrobial Layer - Paulmech Infrastructure Pvt. Ltd., Kolkata
- Two Products related to Covid-19 : Bosetizer (a long-lasting sanitizer) and Bose-Shield (a mask with active respirator) have been commercially launched.

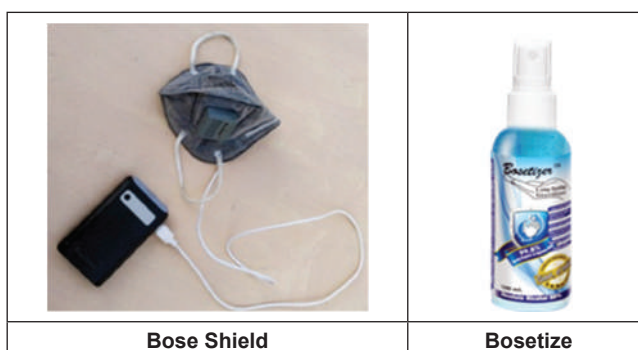

- Integrated PhD (IPhD) programme is conducted in collaboration with the University of Calcutta (CU).
- PhD programme is conducted in collaboration with the Jadapur University (JU) and CU.
- Theoretical Physics Seminar Circuit (TPSC) to promote collaborative research.

Important Output Indicators:

S.No.	Parameters	Output
1.	Papers in refereed journals	138
2.	Papers in Conferences	1
3.	Number of Ph.Ds. produced	5
4.	Indian Patents filed	4
	Indian Patents granted	2
5.	Number of Technologies/Designs and other intellectual products commercialized	3
6.	Number of Technology prototypes awaiting transfer	4
7.	Research Manpower trained (other than Ph.Ds) PDRA	25
8.	Completed M.Sc. under IPhD	13

5.16 Wadia Institute of Himalayan Geology (WIHG), Dehradun

Geodynamics evolution of Himalaya using different proxies and study of Habitants through time. Assessment and monitoring of National Resources and Hazards are the areas of research of the institute.

Major Accomplishments:

- Novel computing approaches for automatic delimitation of 3D subsurface features from surface data.
- Tree-ring based Oct-June temperature record back to 1785 AD in Uttarakhand State.
- A landslide susceptibility map of major tourist towns of Haridwar and Mussoorie.
- Better understanding of Lesser Himalayan rock assembly.
- Moho configuration and geometry of Main Himalayan Thrust along Kali river, Kumaon Himalaya.
- Equilibrium line altitude (ELA) for glaciers in Garhwal Himalaya at 5000–5500m asl based on meteorological records.

Important Highlights of Major Programmes:

- Generated 50,000 year record of glaciation and landscape evolution of Dun valleys and river systems in Kumaun, Garhwal and Indo-Myanmar Range as a function of tectonics and climatic responses.
- Estimated site response functions using 885 seismic waveforms in Kumaun-Garhwal, and obtained seismic spectral amplification level at predominant five frequencies corresponding to various buildings types.
- Discovered micro-fossils of Insectivores from the Siwalik sediments; reported 44 foraminiferal species of 28 genera from Disang Group in the Naga Hills, which has refined the age and paleoenvironmental interpretations of rock succession.
- Provided paleogeography and biotic migration routes of the Neo-Tethys Sea during the middle Eocene based on larger foraminifera biostratigraphy, lithofacies and stable carbon isotope analysis in the Sylhet Limestone in the Mikir Hills, Assam.
- Established a relation for the earthquake precursory based on Radon (Rn-222) continuous data at MPMGO Ghuttu in the Garhwal Himalaya and the role of attenuation characteristics to site effect for seismic hazard studies in the Kinnaur Himalaya.
- Established that Glacier size, orientation, altitude and debris cover control the movement heterogeneity; Topography & climate govern distribution of seasonal snow.
- Showed entrapment of mantle derived carbon dioxide by carbonatite magma from Mineralogical evidences in the Sung Valley, Meghalaya
- Provided geodynamic history of Karakoram Fault (KF) and magmatism in Ladakh Himalaya, and placed ductile deformation along KF between ~27-15 Ma ago.
- Brought out signature of brine, composed of seawater mixed with continental crust-derived fluid in the ophiicarbonates and serpentines in peridotite of Indus ophiolite.
- Developed a new approach of Meta-attribute computation based on supervised neural learning for automatic delimitation/ interpretation of subsurface geologic bodies such as the Mass Transport Deposit from surface data.

Important Output Indicators:

S.No	Parameters	Output
1.	Papers in refereed journals (published and in-press)	105
2.	Chapters in Books	17
3.	Number of Ph.Ds. produced (thesis submitted and awarded)	13
4.	Research Manpower trained (other than Ph.Ds)	20

5.17 National Innovation Foundation (NIF), Ahmedabad

The areas of the Institute includes the Incubation and promotion of technological grassroots innovations including those, which stem from children creativity and to add value to India's outstanding traditional knowledge base. To promote innovations and celebrate creativity of common people, through INSPIRE Awards – MANAK, Festival of Innovation and Entrepreneurship (FINE), Biennial National Grassroots Innovation awards and Dr APJ Abdul Kalam IGNITE Competition for school children.

Major Accomplishments:

- Prototypes of innovative technologies namely Chironji decorticator, manual walnut cracker, lac extraction device, tamarind deseeder, autonomous vehicle for spinal cord injury patients were developed.
- A total of 6.53 lakh ideas and innovations were scouted from all States and UT's of the country for INSPIRE Awards – MANAK with a representation from 702 districts of the country.
- NIF launched a Challenge COVID-19 Competition (C3) which attracted significant participation from common people of the country as more than 1700 innovations were received from 33 States and UT's of the country. Incubated technologies included an innovative sanitization machine by a grassroots innovator in Maharashtra which was implemented in Satana (Maharashtra), Ahmedabad, Jaipur and Tonk, Rajasthan. Similarly, Vehicle Disinfectant Bay was implemented at STNM Govt. Hospital, Gangtok and two checkposts in Sikkim - Rangpo and Melli.
- Developed a novel Ayurvedic formulation - NIFAy.C-19 (CONTAZAP) for management of mild and moderate COVID-19 infection which has received clearance by Ethical Committee and is currently under clinical trials at Chaudhary Brahm Prakash Ayurved Charak Sansthan, New Delhi
- Commercialized an indigenous product 'Estrona' towards treatment of anestrus (infertility) among dairy animals and "Walker with adjustable legs" was launched, both in online marketplaces like Amazon and in the brick and mortar stores by Vissco rehabilitation aids Pvt. Ltd.

Important Highlights of Major Programmes:

- Over 10,800 innovations and traditional knowledge practices from grassroots innovators and knowledge holders were received.
- Validation activities for 38 indigenous medications in treatment of livestock ailments were undertaken.

- 27 agriculture technologies viz. 12 cereals varieties (rice, wheat, sorghum), 4 fruit varieties (grapes, guava, banana), 8 vegetable varieties (cauliflower, onion, hyacinth bean, French bean, Pumpkin, Pea), 2 casuarina varieties and 1 farm practice were validated.
- The field demonstrations of 15 promising varieties were also undertaken at over 1200 farmers' field in 18 states of the country.
- With the objective of strengthening social dissemination of grassroots innovations, implementation along with requisite training for many livelihood generating innovative technologies was undertaken in various parts of country.
- One new outstanding traditional knowledge based enterprise was recognized as Start-Up by Department for Promotion of Industry and Internal Trade (DPIIT).

Important Output Indicators:

S.No.	Parameters	Output
1	Papers in refereed journals	2
2	Books/Monographs	10
3	Papers in Conferences	3
4	Indian Patents filed	8
5	Indian Patents granted	52
6	Plant Variety Applications submitted under PPV&FR Act 2001	2
7	Number of Technologies/Designs, other intellectual products commercialized	6
8	Number of Technology leads awaiting transfer	5
9	Scientific Outreach Programmes organized	220
10	Original Science Communication Content Designed	15
11	Popular Science Books/Newsletters published	3
12	Scientific Lectures/Training Programmes organized	30
13	National Missions Led and Coordinated	3
14	Number of Innovators trained	110

5.18 Technology Information Forecasting and Assessment Council (TIFAC), New Delhi

Areas of focus of TIFAC are Technology foresight exercises, Vision 2035, nurturing innovation, Patenting support, supporting MSME clusters, capacity building, assessment of technological options for electric mobility, collaborative linkages etc.

Major Accomplishments:

Two TIFAC reports were released:

- (i) White Paper titled '*Focused Interventions for 'Make in India' –post COVID-19*', which analyze the impact of COVID-19 during this financial year on various sectors and COVID impact on demand and supply
- (ii) '*Active Pharmaceutical Ingredients- Status, Issues, Technology readiness and Challenges*', which flagged the issues hindering APIs manufacturing in India including major policy recommendations towards making India self –reliant in the sector.
- As a follow-up of the Whitepaper recommendations, 05 thematic workshops were organized by TIFAC on a virtual platform in the focus areas such as i) Health and API ii) Agriculture and Food Processing sector, (iii) Biopharma, Vaccines, Diagnostics and Medical Devices and iv) Machine and Manufacturing Sector v) Post Covid Opportunity for Indian Electronics Sector
 - Under Bioprocess & Bioproducts Programme, a web geo portal named BHUVAN-JAIVOORJA has been developed to assess the availability of biomass and land resources.
 - Draft report on Emerging Energy Storage Technologies prepared with technology trends, technology readiness levels and technology gaps for various emerging energy storage technologies.
 - A new programme on Assessment of Technology Maturity for Atmanirbharta (ATMA) initiated towards evaluation of technologies and ranking them on the basis of degree of maturity for commercialization to create technology portfolio for selected institutions and organizations.
 - The MoU was signed between TIFAC and International Institute for Applied System Analysis (IIASA), which was approved by the Cabinet for cooperation in modeling and research into the dynamics of global change such as energy and climate change, air pollution and health, water, ecosystem services and management.
 - Under the earlier tenure of India-IIASA Programme, two reports namely Development of GAINS model for Indian Cities with NEERI, Nagpur and Conservation of Agro-Biodiversity and Ecosystem Management with Institute for Social & Economic Change (ISEC), Bangalore were published on TIFAC Foundation Day on February 10, 2020.
 - The IPR cell has facilitated and filed 18 new patent applications after due assessment of patentability.
 - Technology Gap Analysis Study for the Saree Cluster in and around Varanasi, Uttar Pradesh was completed by TIFAC with highlights on technical issues and challenges in Saree manufacturing. "Saksham" App was also launched by TIFAC.
 - Six new Technology Gap Analysis Reports were initiated in 7 MSME clusters i.e. West Bengal, Apparel manufacturing cluster, Kolkata, Fisheries & Spices Cluster, Manipur,

Chanapatana Toys Cluster, Karnataka, Katkhal Sital pati cluster, Assam and Sal/Aracanut Leaf Plate Manufacturing Cluster, West Bengal

- Under the KIRAN IPR Programme; 111 Women Scientist have completed one-year training on IPR.

Important Highlights of Major Programme:

- First commercial scale manufacturing facility in India for Ultra-filtration ceramic membrane for application in wastewater filtration was set up in Kolkata by a start-up Need Innovation supported by TIFAC.
- Indigenous technology of single use dynamic bed bio-reactors for production of vaccines and biologics being scaled up by a start-up OmniBRX Biotech, Ahmedabad.
- In a TIFAC support project on Herbal formulation for its application as growth promoter of crops cum animal repellent developed and commercialized by Provimi Products, Erode, Tamil Nadu supported by TIFAC it has shown promising results for protecting cotton crop from Locust swarms which was demonstrated in the Hanumangarh district of Rajasthan.
- Under MSME Programme, more than two hundred and eighty (280 nos.) students have completed technical internships in MSME industries so far. Support for technology development had been provided by TIFAC for nine (9) projects for development of products along with industries.
- TIFAC also prepared draft reports on Food Processing for North Eastern Region of India in six sectors viz. Cereals, Fisheries, Meat & Poultry, Fruits & Vegetables, Spice and Traditional Ethnic Foods. Towards validation and awareness of findings of the reports, three workshops cum panel discussions with stakeholders were convened.

Important Output Indicators:

S.No.	Parameters	Output
1.	Papers in refereed journals	03
2.	Chapters in Books	02
3.	National Conferences Organized	08
4.	State-of-the-art-Reports Published	01
5.	Scientific Outreach Programmes organized	14
6.	Popular Science Books/Newsletters published	03
7.	Number of persons who attended various science outreach programmes/ conferences etc.	1105
8.	Scientific Lectures/Training Programmes organized	61

S.No.	Parameters	Output
9.	Number of students trained	113
10.	Foresight Reports and Analyses Prepared	17
11.	Indian Patents filed (facilitated)	18
12.	Indian Patents granted	9
13.	Policy Report Prepared	01
14.	Number of Technologies/Designs and other intellectual products successfully commercialized	02

5.19 North East Centre for Technology Application and Reach (NECTAR), Shillong

NECTAR focusses on providing last mile guidance and support to north-eastern States in technology applications for socio-economic activities.

Major Accomplishments:

- NECTAR has supported the Project to explore the feasibility and possibility to grow saffron in Northeastern states of India, in association with IA Satyanand Ashram and Sikkim University. Saffron's significant growth and adequate flowerings for production of saffron in Sikkim has been appraised in various forums.



Saffron grown at Sikkim



Distribution of bee boxes



Prototype Bamboo Faucets

- NECTAR also supported a project “transfer of knowledge on scientific bee management and apiary expansion in Mokokchung District, Nagaland” with Nagaland Beekeeping and Honey Mission (NBHM).
- Successfully developed various types of faucets and electrical products under the project ‘Development of Bamboo based sanitary and electrical products’ implemented by M/s San Eco Pvt. Ltd. At Agartala Tripura with objective to develop and manufacture bamboo based sanitary and electrical products to replace plastic and metal with bamboo and explore multiple eco friendly options.

Important Highlight of Major Programme:

- NECTAR has organized 16 informative technical webinars series in the lockdown period lead by eminent experts on Bamboo, water sanitation, food processing, Int engrafted farming, Entrepreneurship, Livelihood generation in NE, Concept on Hydroponics and Financial aspects for budding entrepreneurs.
- Eighteen projects were supported through NECTAR Schemes viz., Technology Outreach Service Scheme (TOSS) and Bamboo Application and Support Scheme (BAANS).
- NECTAR has accomplished a study project on possible damage of Aman Paddy crops due to the Cyclone “Bulbul” and unseasonal rain during October-November 2019 in East Medinapur, North 24 Parganas, South 24 parganas and Ratua-I block of Malda districts of West Bengal by engaging 14 numbers of North Eastern students as interns. The final project report was submitted to Agriculture Insurance Company (AIC) of India Ltd.

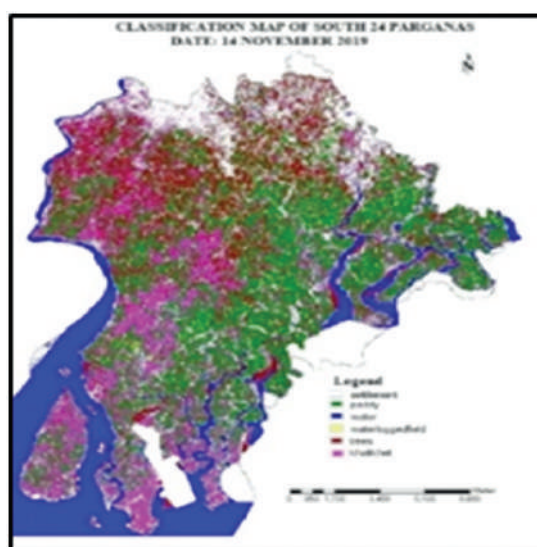

Fig. Paddy crop Map of 24 Parganas

Important Output Indicators:

S.No.	Parameters	Output
1.	National Conferences Organized, sponsored, and participated	06
2.	National Level Online Webinars organized (Lock down series)/ Participated/talks delivered	30
3.	Number of persons who attended various science outreach programs/ conferences etc.	20
4.	Number of students trained	18
5.	Foresight Reports and Analyses Prepared	02

5.20 Vigyan Prasar (VP), Noida

Areas of focus are Science and Technology Communication and Popularization.

Major Accomplishments:

Vigyan Prasar (VP) uses multiple approaches to deliver value-added scientific and technological information/learning for a wide array of stakeholders. VP has established a network of science clubs and ventured into the areas of science communication, training, gender and technology communication, publishing popular science books/ monthly science magazine, developing knowledge products including Audio & Video Programmes for Radio and television.

Important Highlights of major Programmes:

- Produced more than 2000 new video programmes and telecasted on India Science OTT platform. Six hundred telecasted on DD Science channel.
- Produced and broadcast 650 Radio programmes in 19 national languages and regional dialects.
- The Indian Science Wire (Indian Science News Feature Service) released more than 536 stories with over a lakh tweet impression and picked up by digital (2427) Social (1312), print (646) and electronic (161) media.
- “Vigyan Samachar” to aggregate and provide news and related articles on S&T, was initiated and published more than 472 stories in Vigyan Samachar Portal.
- Annular Solar Eclipse Campaign in schools, colleges and villages, distributed Kits and solar filters and organized more than 25 webinars.
- Indian Science Films Festival (on-line). Twenty-five films were awarded.
- Series of on-line lectures as part of Ramanujan Yatra on in all major Indian languages and outreach activities.
- Organized Vigyan Manthan - National Science Talent Search examination. More than one lakh students from 5000 schools participated.
- VP published thirty-five issues of the Covid-19 newsletter, covering about 2100 stories for the benefit of stakeholders.
- Sensitization of five thousand researchers under Augmenting Writing Skills and for Articulating Research (AWSAR) programme. 2063 research stories have been received.
- Gandhi@150, Digital exhibition at 17 locations across the country.

- Monthly newsletters Tajassus (Urdu), Ariviyal Palagai (Tamil) Bigyan Katha (Bangla) and Kutuhhal (Kannada) were published.
- Two hundred fifty short videos on Covid-19 as a daily bulletin on OTT.
- 25 documentary film on various S&T themes, news-based programmes, series on Atman-irbhar Bharat.

Important Output Indicators:

S.No.	Parameters	Output
1.	Papers in refereed journals	17
2.	Books/Monographs	8
3.	Chapters in Books	16
4.	Papers in Conferences	5
5.	International Conferences Organized	3
6.	National Conferences Organized	38
7.	State-of-the-art-Reports Published	4
8.	Scientific Outreach Programmes organized	126
9.	Original Science Communication Content Designed	1325
10.	Popular Science Books/Newsletters published	98
11.	Number of persons who attended various science outreach programmes/ conferences etc. (virtual/online)	5362000
12.	Scientific Lectures/Training Programmes organized	568
13.	National Missions Led and Coordinated	10

5.21 Indian Academy of Sciences (IASc), Bengaluru

The Academy was founded in 1934 by Nobel laureate Sir Prof C V Raman. The Academy strives to meet its objectives through promotion of original research and dissemination of scientific knowledge to the community via a variety of activities that include publishing scientific journals magazines, Recognition of scientific talent, to provide inputs for policies that pertain to science and translation, scientific meetings, discussions, seminars, symposia and science education courses and workshops.

Major Accomplishments:

- Over 1662 peer-reviewed articles in 19147 pages were published in 12 thematic journals and the entire contents are available for free access on the webpages of the academy. Journals during the year had around 2619756 downloads of refereed articles.

- Individuals/universities/other institutions received print version of the journal *Resonance*.
- 11 thematic special publications and 3 books were published.
- Under the Summer Research Fellowship programme, 256 students and teachers availed 2 months' Fellowship. Twenty-two Lecture Workshops were organised.

Important Highlights of Major Programmes:

- The number of journals currently published by the Academy is 12, covering all major disciplines in *science*. The entire contents are available in a free access platform (<http://www.ias.ac.in/journals/overview>).
- 10 journals of the Academy are being co-published with Springer Nature it provides access to the journals' content worldwide on its journal platform *SpringerLink*.
- The academy annually elects distinguished scientists of the country to its Fellowship. It also elects Honorary Fellows, working in institutions outside India, who are distinguished for their contributions to science. 37 outstanding scientists from India and one foreign scientist have been recommended for election into the Academy Fellowship and Honorary Fellowship respectively (with effect from 1 January 2021).
- The Associateship programme was introduced in 1983 to identify and encourage promising young scientists. The Associateship is tenable for a minimum period of 3 years to 6 years. 22 promising young scientists were selected.
- Under the Summer Research Fellowship Programme the Academy offered 1095 fellowships and 102 fellowships were offered under the Focus Area Science Technology Summer Fellowship (FAST-SF).
- The Academy annually holds scientific meetings, symposia and public lectures and encourages other similar activities to provide means of exchange of scientific knowledge among scientists and to bring new knowledge to the attention of the scientific community. During the reported period the 31st Mid-Year Meeting and the 86th Annual Meeting were held virtually. 28 scientific talks by Fellow/Associates and 3 Symposia on topical interest were conducted.
- Symposia to commemorate Vikram Sarabhai birth centenary, Professor Satish Dhawan birth centenary and 3 public lectures were organized during the year.
- IASc also organized webinar lecture series on "Genetics and Evolution".
- New records were added to the Repository on research and review papers published by Fellows in peer-reviewed journals, bringing the total to 106341 articles.

Important Output Indicators:

S.No	Parameters	Output
1.	Papers in refereed journals	9159
2.	Books	3
3.	Journals Published	12
4.	Scientific Outreach Programmes organized	2
5.	Original Science Communication Content Designed (Articles/Face-to-Face)	2
6.	Popular Science Books	1
7.	Number of persons who attended various science outreach prog/conf etc.	530
8.	Scientific Lectures/Training Programmes organized	22
9.	Number of students trained	1466
10.	Number of school/college/university teachers trained	1015
11.	Data Bases Compiled	6

5.22 Indian National Academy of Engineering (INAE), Gurugram

A brief overview of the major activities/achievements of Indian National Academy of Engineering (INAE) is as under:

Major Accomplishments:

- INAE prepared a White Paper on “Technological Preparedness for dealing with National Disruptions” with the objective of facing unknown perils of unanticipated disruptions such as natural and man-made disasters, through “technological preparedness”.
- Constituted INAE Expert Groups to Prepare Technology Roadmaps with Actionable Recommendations on selected engineering themes or domains to serve as inputs for formulation of policies/strategies for implementation.
- INAE submitted the recommendations on the “Development of Regional Transport Aircraft in the country”, emanated from the deliberations of various high level meetings including the Engineers Conclave 2017, held at Bangalore to the stakeholders.

Important Highlights of Major Programme:

- A special issue of Transactions of the Indian National Academy of Engineering - Volume 5, Issue 2, June 2020 on “Technologies for Fighting COVID-19” was brought out and published by M/s Springer.
- Mentoring of Engineer Teachers/Students by INAE Fellow through online/virtual mode.
- The Abdul Kalam Technology Innovation National Fellowship was launched by INAE

jointly with SERB, DST in the year 2017, with the objective of encouraging and supporting translational research in engineering in public funded institutions in the country. Six nominees were selected for conferment of the subject Fellowship in the year 2020-21.

- INAE new features added to the INAE Digital Platform to facilitate INAE Fellows submitting nominations online for Fellowship, schemes and awards and for improved functioning and digitizing of operations.

Important Output Indicators:

S.No.	Parameters	Output
1	National Conferences Organized	3
2	Journals Published	4
3	Popular Science Books/Newsletters published	7
4	Scientific Lectures/Training Programmes organized	16
5	Number of students trained	37
6	Number of school/college/university teachers trained	21
7	Foresight Reports and Analyses Prepared	2

5.23 Indian National Science Academy (INSA), New Delhi

The areas of focus are the Promotion of science in India and harnessing scientific knowledge for the cause of humanity and national welfare.

Major Accomplishments:

- Indian National Science Academy (INSA) is a National body of Indian Science devoted to the pursuit of identifying, nurturing excellence in Science; assisting the government with aspect of policies on science. INSA has been mandated by the Government of India to represent it in all International science fora. INSA achieved all its objectives fully in respect of its mandate of inter-facing with international scientific bodies. The Academy recognizes Indian scientists excelling in their work by electing them as Fellows covering all sciences, engineering, medicine, agriculture, and interdisciplinary research.

Important Highlights of Major Programmes:

- 39 Fellows and five Foreign Fellows to the Fellowship.
- 40 young researchers were selected by the Academy for the INSA Medal for Young Scientists; and one for INSA Young Historian of Science Award.
- 14 outstanding teachers were honoured with INSA Teachers Award.
- A new award Professor SK Joshi Memorial Medal was instituted by INSA in any area of Physical Sciences.

- 01 international, 09 general and 14 subjectwise medals/lectures awards were announced by the Academy.
- INSA and the Royal Society, London, jointly organized Yusuf Hamied Foundation sponsored bilateral workshops, one each in Physical Sciences and Biological Sciences area, in UK. These workshops were focused on “Condensed Matter – Neutrons, X-rays and Muons and Genome Editing for Healthcare and Agriculture”.
- Under the Science Promotion Programme, INSA supported 02 Distinguished Professors, 64 Senior Scientists and 21 Honorary Scientists for advanced research in their specialized disciplines.
- 66 scientists were offered the Visiting Fellowship under Visiting Fellowship Scheme for collaborative research and training of their research capabilities by INSA.
- Under the History of Science Programme, the Academy supported 22 research projects.
- 06 popular lectures were delivered to young students and teachers of schools and colleges by the INSA Fellows, Young Scientists, Teacher Awardees and The Indian National Young Academy of Science (INYAS) members in remote/rural areas; Five award lectures under the aegis of different local chapters of the Academy were delivered under Science and Society Programme.
- During the year, three special publications namely, “Indian Science Transforming India” in English (reprinted), “Biomaterials Science and Implants: Status, Challenges and Recommendations” and the autobiography of Professor M Vijayan “M Vijayan: A Life with Men, Women and Molecules” were published by INSA.

Important Output Indicators:

S.No.	Parameters	Output
1.	Books/Monographs	03
2.	Journals Published	03
3.	Scientific Outreach Programmes organized	01
4.	Popular Science Books/Newsletters published	02
5.	Number of persons who attended various science outreach programmes/conferences etc.	600
6.	Scientific Lectures/Training Programmes/award lectures (online) Organized	18
7.	Number of students trained	874
8.	Number of school/college/university teachers trained	89

5.24 The Indian Science Congress Association (ISCA), Kolkata

The ISCA is working on the popularisation and advancement of science by organising seminars, symposia, discussions, popular lectures, quiz contest, etc. thought out the year under twenty six ISCA Chapters.

Major activities of ISCA during the year under report are as follows:

- 107th Indian Science Congress Session at University of Agricultural Sciences, Bangalore.
- Publications including ISCA bi-monthly journal Everyman's Science.
- Augmentation of 26 ISCA Chapter Activities.
- Young Scientists' Award Programme
- Best Poster Presentation Award Programme
- Science Awareness Programme for Popularisation of Science
- Advancement and Promotion of Science and Technology through National/International Symposia, Follow-up of Recommendation(s) Involving Young Scientists
- International Collaboration on Exchange Programme
- Infrastructure Development
- Institution of ISCA fellowship (FISC)
- Asutosh Mookerjee Fellowship for Senior Scientists
- 32 ISCA Awards and Endowment Lectures

5.25 The National Academy of Sciences (NASI), Allahabad

The Academy continued to promote Science & Technology by regularly organizing several activities with the help and support of its Fellows and Members. During the year of the report, the following activities were undertaken. Area of focus of the NASI are Promotion & Popularization of Science & Technology to aid & advise in Policy Making

Major Accomplishment:

- NASI published the Proceedings of NASI, Sec. A & B, each in IV parts and National Academy Science Letters in VI parts, in collaboration with the Springer Nature.
- National Academy Science Letters received about 550 papers from 25 countries/regions.
- A Book on 'Vector Biology and Control' was also published it is complete book is on NASI's website at - http://nasi.nic.in/BCIL%20Vector%20Biology%20PDF_%2014th%20Aug%202020.pdf

- PNASI, Sec. A received Impact Factor (IF) as 0.681 in 2019 from Thomson Reuters; and about 350 papers were received from twenty one countries/regions.
- The PNASI, Sec. B received 400 papers from 32 countries/regions.
- Under Science Communication Activities Children Science Meet, Winter School, Teachers' Training Workshops, Vigyan & Health Chaupals through webinars/online Lectures, were organized.
- The Academy encouraged the teachers for out-of-the-class science activities by recognizing their talent and giving away NASI-Science Teacher's Awards to them.
- NASI's 22 Chapters spread across India, organized several science communication activities (online) in and around their respective regions throughout the year. More than 50,000 students and teachers benefitted from these activities.
- Science Education Programmes in joint collaboration with other Academies.
- For General Awareness – on Nutrition, Health & hygiene, Awareness for COVID-19, etc. A mixed participation of rural and urban population was ensured by NASI. This was included in the spirit of “**Swasth Bharat Mission**”, ‘**Poshan Programme**’ and ‘**Jagrukta Abhiyan**’, and more than **dozen programmes** were organised through online mode.



Poshan Maah Programme organised in Jayapur Village, Varanasi in Sept 2020



COVID-19 awareness camp, jointly organized by National Academy of Sciences, India (Jharkhand Chapter), SEEDS & CSIR-NML, on Nov.1st, 2020 at a tribal village of West Singhbhum district. Volunteers explained the importance of sanitization, hygiene and face mask to the natives of the village in 'Ho' dialect.

- To inculcate the spirit of entrepreneurship in the youth and in line with the National Mission Programmes of Skill Development and Start Up India, NASI organised programmes at NASI-Jharkhand Chapter, NASI-Bhopal Chapter and NASI-Varanasi Chapter, during the year.

- Mega Event on the 'Science & Technology Intervention for the Tribal Welfare', was organized at Institute of Life Sciences (ILS), Bhubaneswar, in which about 300 participants attended from all across the country representing 22 Tribal Welfare Centres established by NASI under the DST's Tribal Sub Plan Support.

Important Highlights of Major Programmes:

- The Ganga-gallery (IGNOU, New Delhi has included the gallery in its syllabus/projects; UP Tourism and Consortium of IITs have also included the gallery on their websites) and the Brahmaputra gallery have been dedicated to the nation; while the third on river Cauvery has also been established recently at Mysuru.
- NASI together with other two National Science Academies is jointly sponsoring the Summer Research Fellowship under joint Science Education Panel.
- Continuing its established collaboration with the Reliance Industries, SCOPUS and Springer, for recognizing the talent in scientific research.
- Also organized many science communication/ popularization activities (WEBINARS) in collaboration with the Indian Universities/ IITs & other Institutes/CSIR Laboratories/DST Institutions/NCSM and other prestigious institutions.

Important Output Indicators:

S.No.	Parameters	Output
1.	Papers in refereed journals(by Chairs, NASI-Senior Scientists & the researchers)	130
2.	Books/Monographs	2
3.	Chapters in Books (by NASI-Senior Scientists & researchers)	5
4.	National Conferences Organized	20
5.	State-of-the-art-Reports Published	5
6.	Journals Published Sci. Letters (PNASI-A & B)	14
7.	Scientific Outreach Programmes organized	30
8.	Number of persons who attended various science outreach programmes/ conferences etc.	50,000
9.	Scientific Lectures/Training Programmes organized	30
10.	Number of students trained	750
11.	Number of school/college/university teachers trained	800
12.	Data Bases Compiled (on Tribal Population / area / products etc.)	08
13.	Foresight Reports and Analyses Prepared (on COVID-19)	05

SCIENCE AND ENGINEERING RESEARCH BOARD

The Science and Engineering Research Board (SERB), a Statutory body of Department of Science and Technology (DST), empowered through an Act of Parliament, has taken several significant steps in R&D management. The SERB (Board) interventions are primarily focused to expand the research base in the country without compromising the quality of research. Investing in young minds and in new areas of science had turned out to be the prime priorities of the Board.

The Board, chaired by Secretary, DST, comprised of 16 members including six Secretaries to the Government of India, met twice in the reporting period, and had taken key decisions, which have profound influence in the S&T landscape. Some of the decisions taken by the Board are given below:

Accelerate Vigyan: In order to provide a single platform for research internships, capacity building programs, and workshops across the country SERB had launched a new scheme called 'Accelerate Vigyan' (AV). The primary objective of this inter-ministerial scheme is to give more thrust on encouraging high-end scientific research and preparing scientific manpower, which can lead to research careers and knowledge-based economy. Recognizing that all research has its base as development of quality and well-trained researchers, AV will initiate and strengthen mechanisms of identifying research potential, mentoring, training and hands-on workshop on a national scale.

SERB & Industry Partnership – The Scheme for Funding Industry Relevant R&D (IRRDR) of SERB aims to utilize the expertise available in academic institutions and national laboratories to solve industry specific problems for the larger benefit of society. The scheme supports ideas that address a well-defined problem of industrial relevance in a project mode. Under IRRDR Scheme, SERB, in a process to enhance industry engagement in public funded research, launched a Programme 'Fund for Industrial Research Engagement (FIRE)'. A letter of Intent had been signed with industry leaders like Applied Materials India Private Limited, Intel Technology India Private Limited, Mentor Graphics Private Limited, NXP India Private Limited, Texas Instruments (India) Private Limited and GE India Private Limited.

National Postdoctoral Fellowship - Extension due to lockdown: SERB, considering the impact of COVID-19 on the planned research work of National Postdoctoral Fellows (NPDFs), had approved extension of the tenure of the Fellowship for a period up-to six months with

fellowship. The extension allowed the NPDFs to complete the work as originally planned and suffered due to lockdown.

6.1 Initiation and Implementation of the following new schemes:

6.1.1 SERB-POWER (*Promoting Opportunities for Women in Exploratory Research*)

To mitigate gender disparity in science and engineering research funding in various S&T programs in Indian academic institutions and R&D laboratories. SERB-POWER is specially designed to provide structured effort toward enhanced diversity in research to ensure equal access and weighted opportunities for Indian women scientists engaged in research and development activities.

Women Scientists in regular service in academic and research institution will be supported under two categories, namely, SERB –POWER Fellowship and SERB –POWER Research Grants. The details are given below:

- i. **SERB-POWER Fellowship:** - Successful Women Scientists will be provided a personal Fellowship of Rs. 15,000/- per month in addition to regular income and a Research grant of Rs. 10 lakh per annum for a period of three years.
- ii. **SERB-POWER Research Grant:** - POWER Grants will empower women researchers by funding them under following two categories:
 - Level I (Applicants from IITs, IISERs, IISc, NITs, Central Universities, and National Labs of Central Government Institutions): The scale of funding up to 60 lakhs for three years.
 - Level II (Applicants from State Universities / Colleges and Private Academic): The scale of funding up to 30 lakhs for three years.
- iii. **IRHPA Cryo-Electron Microscopy Facility:** SERB recognized the sub-optimal Cryo-EM research facilities that existing in the country and felt that our country should have a finite number of state-of-the-art Cryo-Electron microscopy facilities to create research knowledge base and skills for cryo-EM research and thereby establish leadership in structural biology, enzymology, ligand/drug discovery, and to combat new and emerging diseases. A national call was made to invite proposals in the area of Cryo-Electron Microscopy for Macromolecular Structures and Complexes.

Given the various regions of the country desirous of up scaling cryo-EM based structural biology research, the Board approved four machines for North, East, West, South regions with similar facilities and equal budget. These Centres are called as SERB National Facility for Cryo-Electron Microscopy. Accordingly, the Board sanctioned following centres under IRHPA.

- North India Facility for Cryogenic-Electron Microscopy at IIT Kanpur, Kanpur
- National Facility of Cryo-Electron Microscopy: Remotely Operable, 24x7 for Academia and Industry at IIT Madras, Chennai
- Acquisition of State-of-the-Art Cryo-Electron Microscopy Instrument for Developing National Facility at IIT Bombay, Mumbai
- State-of-the-Art CryoEM Regional/National Facility in Eastern Region at Bose Institute, Kolkata
- The core of the facility is a Cryo-EM - 200kV machine- DED / CCDs camera and auto sampler with necessary software and accessories. Each facility costs Rs.28.6 crores for four years.

6.1.2 SERB on Covid-19

The reporting year marred with the COVID 19 Pandemic has seen some of the finest R&D efforts by the Indian scientific community. The Board was in forefront in initiating value-added programmes to address different facets of R&D management on COVID-19 pandemic. Key R&D initiatives of SERB on COVID-19 are given below. Several projects were supported through the following initiatives.

- A. CRG COVID-19 Calls:** Considering the emerging health care requirements to combat the COVID-19 epidemic, DST-SERB announced rapid/short-term projects in various thrust areas, preferably with multidisciplinary efforts under Core Research Grant (CRG) to urgently ramp up national R&D efforts against the epidemic. Projects were identified in areas like *antiviral nanomaterials and bionano antiviral systems; drug repurposing against key COVID-19 targets; affordable, portable rapid diagnostic kits / tools; computational identification and validation of COVID-19 molecular targets; in-vitro / clinical dose testing of nutritional supplements for immunity* etc.
- B. IRHPA COVID-19 Calls:** Another Special IRHPA Call (Intensification of Research in High Priority Area) for a 3-year duration specifically designed for COVID-19 and related respiratory viral infections was announced. The preference to multi-institutional network with industrial partnership to assist teams, preferably with multidisciplinary efforts in the area was encouraged in the IRHPA call. The thrust areas were *new or repurposed antivirals against valid viral targets; viricidal coatings; affordable diagnostics for symptomatic and asymptomatic respiratory viral infections; investigational vaccines against respiratory viruses; development of disease models for respiratory viral infections; studies on immune response and immunity during respiratory viral infections; epidemiology of COVID and other respiratory viral infections*.
- C. MATRICS COVID-19 Calls:** Considering the importance to develop mathematical models to study the rate of spread of COVID-19 among the population and also the

criticality of data driven inference for forecasting of coronavirus infections, SERB announced special call for short-term projects under its MATRICS program, preferably with multidisciplinary efforts in areas like Mathematical Modeling of COVID-19 Spread; Statistical Machine Learning, Forecasting and Inferences from Pandemic Data; Focused Algorithms for Infectious Disease Modeling; Quantitative Social Science Approaches for Epidemiological Models.

- D. SERB-COVER (COVid-19 Emerging Research):** As a follow-up of Covid-19-specific R&D calls, SERB has initiated a series of webinars titled as SERB-COVER (COVid-19 Emerging Research) to showcase the work being done by investigators supported by SERB. In this webinar, selected Principal Investigators supported under different COVID-19 programmes would be called for presentations. Eminent scientists working in the similar areas and expert members from the COVID-19 programme committees will also deliberate upon the recent developments on the COVID-19. SERB has conducted two webinar sessions on the theme “Antiviral Materials and Surface Decontamination Approaches for Covid-19”.
- E. Scientific Webinar on Indo-Italian Cooperation for COVID 19:** A Scientific Webinar on Indo-Italian Cooperation for COVID 19 was organised on 14th July in collaboration with Embassy of India in Rome and Embassy of Italy in India. The scientific session on meeting the acute phase of COVID 19 pandemic included sharing of research findings across both the countries by six eminent speakers from both the countries with the updates on vaccine research, use of drug repurposing in management of disease and the development of diagnostics to contain the spread of coronavirus disease.
- F.** SERB joined a Committee on COVID-19 India National Supermodel, constituted by DST. Mathematical models developed through this initiative had been used to study progression of the COVID-19 Pandemic in India, prognosis and lockdown Impacts.
- G.** Several scientists from across academic and research institutions were supported through a wide variety of ongoing schemes/programmes in the reporting period. Some of the notable ones are:
1. Ramanujan Fellowship is for brilliant scientists and engineers from all over the world to take up scientific research positions in India. This fellowship is open to scientists and engineers below the age of 40 years. The J.C. Bose National Fellowship is meant to recognize active, performing scientists and engineers for their outstanding performance and contribution. Visiting Advanced Joint Research (VAJRA) Faculty Scheme: The Scheme offers adjunct / visiting faculty positions to overseas scientist / faculty / R&D professional including NRIs to undertake high quality collaborative research in Public funded academic and research Institutions in India. The Scheme facilitates sustained international collaborative research with co-guiding of Master’s, PhD and post-doctoral students as well as expose the best of our young minds to the

best of global research practices and enhance our access to the state-of-art facilities in other countries. It is structured to promote cutting edge collaborative research in frontier areas of S&T including the interdisciplinary areas of national priorities such as energy, water, environment, health, security, nutrition, waste processing, advanced materials, high performance computing, cyber-physical systems, smart machines and manufacturing, etc., for accelerated development of scientific and technological progress for the overall economic prosperity of the nation.

On recommendation of the Selection Committee and Apex Committee of VAJRA Faculty Scheme, SERB selected 21 accomplished overseas scientists including NRIs / OCIs for the award of SERB-VAJRA Adjunct Faculty positions. This includes 13 scientists from USA, 3 from Germany, 2 from France and one each from South Africa, Australia and Finland.

2. The Board invited applications under Scheme titled “SERB-TETRA” (Technology Translation Award) to challenge scientists executing SERB grants to establish an effective, functional and synergistic working collaboration with an industry partner to elevate their breakthrough results and technologies to Technology Readiness Level (TRL) 5 and beyond.

Two projects have been identified under “SERB-SUPRA (Scientific and Useful Profound Research Advancement)” that seeks to explore new scientific breakthroughs, with long-term impact on our fundamental scientific understanding.

3. IMPacting Research INnovation and Technology (IMPRINT): SERB continued to steer the IMPRINT - II Programme of DST- Ministry of Human Resource Development (MHRD) to address major engineering challenges relevant to India through an inclusive and sustainable mode of translational research steered by the top engineering institutions in the country. The Programme identified 10 technology domains namely: (1) Healthcare, (2) Energy, (3) Sustainable Habitat, (4) Nano Technology hardware, (5) Water resources and river systems, (6) Advanced materials, (7) Information and Communication Technology, (8) Manufacturing, (9) Security and Defence, and (10) Environmental Science and Climate Change that could substantially impact the quality, safety and security of life both in urban and rural areas. Call for applications for IMPRINT Consortia proposals were made in the reporting period.
4. National Science Chair (NSC): The aim of the NSC scheme is to recognise active eminent senior resident Indian superannuated scientists for their outstanding contributions both nationally and internationally, in the area of Science, Technology, Engineering, Mathematics (STEM) and Medicine, to promote excellence and growth in R&D. Five National Chairs were awarded during the reporting time.

5. The Board continued to support scientists and technologists belonging to weaker sections of the society the “Empowerment and Equity Opportunities for Excellence in Science” Scheme. The scheme provides research support to scientists belonging to SC/ST categories and it received overwhelming response.
6. Programme Advisory Committees continue to play a decisive role in providing core research support to scientists. Highlight of some of the Core Research Grant (CRG) projects are depicted below:
 - *A project on Paleogene fossil soils of the NW Himalayan Foreland Basin: Implications for the oldest tropical weathering and monsoonal conditions over the Indian subcontinent under implementation at University of Delhi.*

Main aim of the project was to Explore the fossil soils from the oldest continental sediments of the HFB to comprehend the Paleogene weathering process and inception of paleo monsoon over the Indian sub-continent. Main findings of the completed project show: Latitudinal shift and climate change and the evolution of red and yellow paleosols of Himalayas: Evidence for the early Oligocene seasonality and its strengthening in Miocene (Fig.1). This provides details of the fluvial sedimentary sequences from HFB to interpret weathering and pedogenesis during early Oligocene to Mid-Miocene time. Palaeopedological investigation of a 3.1 km thick succession from Kangra sub-basin of the HFB shows the lower 2 km part of the succession is characterized the red (10R hue) and the upper 1.1 km part of the succession by the yellow (2.5Y hue) paleosols with varying intensity of weathering and pedogenesis. The association of sedimentary rocks and pedogenic expression in paleosols indicate four (Type-A to Type-D) of pedofacies in the entire Oligocene-Miocene succession. The pedofacies are defined by a decrease in the intensity of palaeopedogenic development from strongly developed palaeopedofeatures in Type-A, moderately developed palaeopedofeatures in Type-B, weakly developed palaeopedofeatures in Type-C and to the only incipient stage of palaeopedogenesis in Type-D pedofacies. The paleo latitudinal shift during the convergence of Indian Plate played a major role in weathering and palaeopedogenesis with the inception of seasonality during the early Oligocene, which is demonstrated by the formation of the red paleosols with pedogenic CaCO_3 and vertic features in tropical conditions. The transition to yellow paleosols at about 20 Ma is marked by increased humidity, rapid aggradation, pronounced uplift and enhanced erosion of the hinterland. These yellow paleosols are characterized by the abundance of weakly developed Bw and Bss horizons, pure clay pedofeatures and absence of any pedogenic CaCO_3 during short pedogenic intervals in subtropical conditions. During the project duration, one research scholar has completed her PhD on paleopedological aspects of the Himalaya. One major publication has already come out in *Sedimentology* (DOI:[10.1111/sed.12699](https://doi.org/10.1111/sed.12699) , 2019). In this publication, SERB funding though this project has been duly acknowledged.

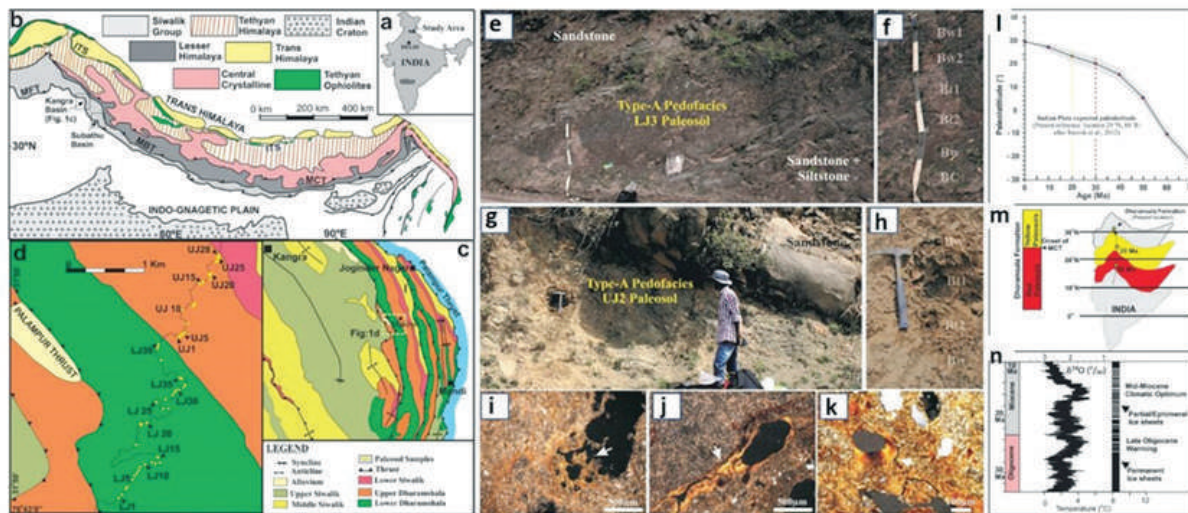

Fig.1 (a) Location of the study area, (b) Kangra and Subathu sub-basins in the HFB, (c) General geology of the Kangra basin, (d) Red paleosols (LJ1-LJ39), yellow paleosols (UJ1-UJ28), (e) well-developed red paleosol and Type-A pedofacies and (f) different paleosol horizons, (g) well-developed yellow paleosol and (h) its horizons, (i) illuvial features, (j) pure clay coatings, (k) microlaminated pure clay coatings, (l), (m), and (n) explains the role of paleolatitudinal control on formation of the red and yellow paleosols in the HFB during 31 Ma to 13 Ma (after Upreti and Srivastava, Sedimentology 2019).

- Another project on “Bio-assay guided Isolation, Identification and Elicitation of Anticancerous bioactive compounds from *Nardostachys jatamansi*, *Psoralea corylifolia* and *Plumbago zeylanica*” has given following interesting results.

Plant based natural products have a long history in the treatment of cancer and this gained momentum also due to the National Cancer Institute’s drive to test various plant extracts against sixty human cancer cell lines on panels in the late 1980’s. Various anti-cancerous compounds have already been commercialized for instance vincristine and vinblastine from *Carharanthus roseus*, taxol from *Taxus brevifolia* and the list is endless with many more in development and clinical trials. This project aims towards screening of anti-cancerous potential of important medicinal plants like: *Nardostachys jatamansi* D. C., *Psoralea corylifolia* L., and *Plumbago zeylanica* L. against different cancer cell lines and identification and elicitation of bioactive compounds. Some important observations are given below:

- ***Nardostachys jatamansi* (D. DON) DC.** is reported to be the best medicine against various neurological disorders and brain related functions like cognition and memory (Kulkarni et al., 2010). Roots and rhizomes of *Nardostachys jatamansi* are used to treat epilepsy, hysteria, mental weakness, insomnia and convulsions as mentioned in Ayurveda (Bagchi et al., 1991, Rao et al., 2005, Subashini et al., 2006, Kumar et al., 2011). *Nardostachys jatamansi* rhizome extract (NJRE) showed induce cell death by apoptosis in glioblastoma cells as decreased expression of caspase 3, caspase 9 and PARP was seen through immuno blotting assay.

- ***Cullen corylifolium* (L.) Medik.** (Syn: *Psoralea corylifolia* L.) has been used to treat various ailments related to skin like psoriasis, leucoderma, chronic skin disease, scabies, ringworm, vitiligo, etc. and it is also effective against cancer and other diseases like leprosy (Tang et al., 2007, Uikey et al., 2010). Immuno-blotting assay of green seed extract showed induced cell death by apoptosis in the U87 MG and U373 MG cells after 24h of treatment. There was a decrease in the expression of caspase 3, caspase 9 and PARP in the treated cells indicating the activation of mitochondrial mediated intrinsic pathway of apoptosis in both the cell lines.
- ***Plumbago zeylanica*** has been used to treat various diseases like dyspepsia, skin diseases, cancer and rheumatism. *Plumbago zeylanica* comprises set of chemical compounds which are responsible for various properties of this plant. Methanolic extract of *P.zeylanica* root showed cyto-toxicity against breast cancer, colon cancer (Aditya et al., 2013) *P. zeylanica* root extract (PZRE) exhibited cyto-toxicity on Mia-pa-ca-2 (Human pancreatic cancer cell line) and Colo 320DM (Human colon cancer cell line) cells as evaluated through MTT assay, its IC₅₀ values being 55.96 µg/ mL and 48.25 µg/mL, respectively, after 24-h of treatment. Tissue culture approached was also adopted for enhancement of plumbagin (secondary metabolite).

Six papers published, 8 paper presentations and one patent have been filed from this project.

- *A project on Design and Development of Optical Microfiber based Acoustic sensors for Under/Over Water Applications at Indian Institute of Technology, Bhubaneswar reported the following:*

The PI's group developed a working prototype of an optical fiber micro-tip based hydrophone for online and remote detection of acoustic signal. The packaged optical fiber hydrophone of dimensions 1.4 cm x 1.4 cm x 2 cm and shows a high sensitivity of 8.94 nm/mPa or -41.42 dB re 1 nm/µPa at 1 KHz. The hydrophone shows an excellent signal to noise ratio and the noise-limited minimum detectable pressure is as low as 0.388 µPa/Hz at 1 KHz which is better than the commercially available system. The linear working range of the hydrophone is 0-3950 Hz. The experimental results show that the proposed optical fiber hydrophone can very accurately detect the click trains produced by dolphins for echolocation. The patent has been filed. Also, we are in discussion with some of the Indian Companies for its prototype development and field trial.

They propose and demonstrate a fiber taper based in-line intermodal Mach-Zehnder interferometer (MZI) as a hydrophone with high performance, practical and economical system for low-frequency acoustic signal detection. The hydrophone shows a sensitivity of 14.02 nm/kPa and a minimum detectable pressure of 651 Pa/Hz in the low-frequency range (100 Hz).

They propose a low-cost acoustic sensor using tapered fiber structure attached to a nitrile

polymer. The acoustic sensitivity and minimum detectable pressure at 2500 Hz are 36 mV/kPa and 21.11 Pa/Hz, respectively, for the sensor setup with tapered fiber waist diameter of 18.37 μ m. The sensor shows a reasonably flat response from 250 to 2500 Hz.

Optical microphone consisting of a single mode fiber (SMF) tapered micro-tip in cantilever configuration for detection of low frequency acoustic signals developed (Fig.1). Acoustic waves of 100-2000 Hz were detected successfully using the proposed microphone as shown in figure. Experimentally found that for a cantilever length of 15 mm, the probe has an acoustic sensitivity of 10.63 mV/Pa.

A simple and high sensitive optical microphone/hydrophone based on S-shaped tapered (STF) fiber is proposed and demonstrated (Fig.2). The proposed sensor shows highest sensitivity of 3.07 mV/Pa and minimum detectable pressure of 36.48 mPa/Hz. The sensor shows a linear response upto 1300 Hz.

Square Knot Resonator (SKR) based bending and hence acoustic sensor developed. The SKR is fabricated by carefully and systematically intertwining two microfibers with each other. The reported SKR has an FSR of 0.505 nm, and the Q-factor is more than 14500. The experimental results, in agreement with theoretical results. This shift in terms of sensitivity is 3.04 nm/m-1. The SKR shows a temperature cross-sensitivity of 3.2 pm/C. The multi-port micro-sensing system of the SKR can be used to cascade an array of sensors to enhance the spatial resolution.

Further for all the structures, depending on the applications, the performance parameters of hydrophones can be tailored as by user's requirement.

PI's group has published 13 papers in SCI journals and applied for patents.

7. Under the Intensification of Research in High Priority Areas (IRHPA) Scheme, following projects were reported with significant results:

- *Atmospheric Studies in the Geophysically sensitive Tropical to Sub-tropical transition region with ST Radar Facilities at Calcutta University supported under the IRHPA Scheme is another important facility under implementation*

An indigenously developed, state-of-the-art 53 MHz VHF ST Radar is being established at Ionosphere Field Station, Haringhata of University of Calcutta, and when commissioned, will be the first radar at this frequency in an Indian University. Once established, this Radar would become a unique facility in the entire eastern and north-east parts of the country as well as the South-East Asian longitudes. This radar is located in the transition region from the tropics to the sub-tropics and proximity of land and sea. It will facilitate research on Stratosphere-Troposphere Exchange processes, atmospheric dynamics, turbulence, development of models for forecasting severe weather events, role of atmospheric gravity waves in development of weather

systems and ionospheric effects on radio signal propagation. Data analyses and interpretation using a Pilot version (Fig.1) of the main array (Fig.2) in collaboration with other national laboratories were carried out. This project is at a very advanced stage with civil and electrical work at the radar site being underway following which installation and commissioning of the radar will take place.



Fig. University of Calcutta ST Radar Pilot Array

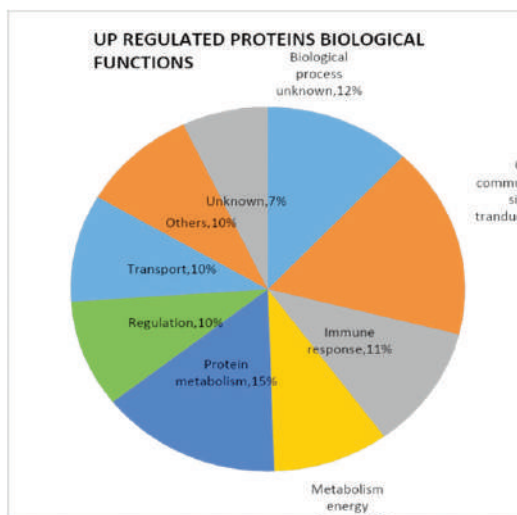

Fig. University of Calcutta ST Radar Main Array

- *Strengthening of Research and Development in Cancer Biology at Cancer Institute [WIA], Chennai*

Ovarian cancer is the seventh most common cancer and eighth leading cause of cancer associated death in women. It is a silent killer since most patients do not have any symptoms in the early stage or have non-specific symptoms which are usually ignored, resulting in most patients presenting in advanced stages of the disease. Additionally, early detection of ovarian cancer has not been possible due to lack of reliable markers or diagnostic tests.

Under IRPHA scheme DST-SERB supported a project to Adyar Cancer Hospital, Chennai, towards identification of early biomarkers in the blood which can help in the diagnosis of epithelial ovarian cancers, which accounts for over 90% of the ovarian cancers.



Investigators collected blood samples from 138 ovarian cancer patients, 20 patients with benign ovarian cancers and 238 healthy subjects. Using high end proteomics [Tandem Mass Tag (TMT) based quantitative analysis by high resolution mass spectrometry] they have identified nearly 500 blood proteins which were differentially expressed in epithelial ovarian cancer patients compared to healthy subjects. Followed by two stage validation was undertaken. In the first stage using Quantibody array technique investigators narrowed down 21 proteins out of 500 which were found to be significantly either up- or down-regulated in epithelial ovarian cancer patients compared to healthy subjects.

In the 2nd stage, 9 proteins (CA125, CFD, CST3, ICAM1, IGFBP2, IGFBP3, SPP1, TSP1 and VEGFA) found to be expressed at different levels between healthy subjects and epithelial ovarian cancer patients were assessed using sandwich ELISA for each individual protein.

Using the ELISA assays, a combination of 5 markers (CA125, IGFBP2, SPP1, TSP1 and ADI) showed 90.24% sensitivity and 94.87% specificity.

Overall significance: It is well designed case-controlled study with large and well-defined cancer patient population ((epithelial ovarian cancers including serous and mucinous subtypes), age matched controls and benign ovarian tumors. This study also incorporated a discovery phase involving quantitative proteomic analysis of immune-depleted plasma followed by two levels of validation studies involving a selected list of proteins using antibody arrays and ELISA.

A patent application for “ Biomarkers for early diagnosis of ovarian cancers” has been filed with an application number of 201741011879. The outcome of the work has been published in quality peer-reviewed journal in “Journal of Proteomics”

8. COVID 19 Special call has resulted in supporting following project:

In Silico Analysis of 10000 Genomic Sequences of SARS-CoV-2 around the World including India to Identify Genetic Variability and potential Molecular Targets in Virus and Human at National Institute of Technical Teachers’ Training and Research, Kolkata.

The above project was approached at different components, (a) to provide a machine learning based predictor that can predict Coronavirus from other pathogenic viruses, (b) to identify the genetic variability in SARS-CoV-2 genomes around the globe including India, (c) to identify the number of virus strains is available using Single Nucleotide Polymorphism (SNP), (d) to identify the potential target proteins of the virus and human host based on Protein-Protein Interactions as well as by integrating the knowledge of genetic variability, (e) to identify the putative Epitopes as candidates of synthetic vaccine based on genomic conserved regions that is highly immunogenic and antigenic and (f) to identify the virus miRNAs that are also involved in regulating human mRNA.

track 2, (c) SNPs present in more than 10% of SARS-CoV-2 population for Global and India, (d) Screenshots of the web application before and after executing search query

9. Start-up Research Grant is one of the flagship programmes of SERB. The scheme aims to provide research support to the researchers who are in their early career for pursuing exciting and innovative research in frontier areas of science and engineering. A large number of projects were sanctioned to young scientists from across various institutions from the country. A significant number of high impact SCI publications have emanated from several projects.
10. Teachers Associateship for Research excellence (TARE): A total of 86 proposals were recommended for the TARE award. This includes 18 proposals in chemical sciences, 9 physical sciences, 1 in mathematical sciences, 3 in earth and atmospheric sciences, 22 in life sciences, and 33 projects in engineering science. PI from the on-going TARE projects have published about 70 research papers in reputed international and national journals with the impact factors ranging from 0.83 to 10.2 with an average impact factor of 2.86. This evidences the success of the program in bringing out the research abilities of the researcher not having opportunity to execute the work.
11. In the reporting period 270 young researchers have been offered National Postdoctoral Fellowships. The NPDF Scheme is aimed to identify motivated young researchers and provide them support for doing research in frontier areas of science and engineering. The fellows are to work under a mentor, and this training is to provide them a platform to develop as an independent researcher.
12. The online portal www.serbonline.in has been made operational for most of major schemes of SERB.

TECHNOLOGY DEVELOPMENT BOARD

The Government of India constituted the Technology Development Board (TDB), under the Technology Development Board Act, 1995, as a statutory body under the Department of Science and Technology, Government of India to promote development and commercialization of indigenous technology and adaptation of imported technology for wider domestic application in September 1996.

TDB provides financial assistance to the industrial concerns and other agencies attempting development and commercial applications of indigenous technology or adapting imported technology for wider domestic application, by way of loan (upto 50% of unincurred total project cost @5% simple interest), equity (upto 25% of the total project cost) or grant (in exceptional cases).

In pursuance to its mandate, TDB accepts applications for financial assistance throughout the year from all sectors of economy such as Health & Medical, Engineering, IT, Chemical, Agriculture, Telecommunications, Road Transport, Energy & Waste Utilization, Electronics, Defence, Civil Aviation, Textile etc..

This year when the whole globe was put on standby due to Covid-19 pandemic, TDB issued a call for proposal “**Fighting COVID-19**” on March 20, 2020 and invited proposals/applications from Indian companies and enterprises to address the unprecedented situation of COVID-19. Through online process, nearly 350 companies registered themselves and approximately 225 applications were received. Some of the supported companies include:

- M/s Mylab Discovery Solutions, Pune signed a Grant Agreement with TDB for the project proposal entitled “*Manufacturing of Testing Kits to detect Covid Corona Virus*”. It is the first indigenous company to develop a real-time PCR based molecular diagnostic kit that screens and detects samples of people who display flu-like symptoms. TDB has sanctioned a grant assistance of Rs. 400.00 lakh out of total project cost of Rs. 1360.00 lakh to M/s Mylab Discovery Solutions, Pune vide Grant Agreement dated 22.05.2020.
- M/s Thincr Technologies India Pvt. Ltd, Pune signed a Grant Agreement with TDB for the project proposal entitled “*Development of low cost and more efficient masks coated with antiviral agents to protect spread and protection of Covid-19 and other viral infections*”. The company is involved in the coating and 3D printing of anti-viral agents on the masks as a preventive measure against COVID-19. TDB has sanctioned a Grant assistance of Rs. 7.50 lakh against total project cost of Rs. 27.40 lakh vide Grant Agreement dated 08.07.2020.

- M/s Medzome Life Sciencez, New Delhi signed a Grant Agreement with TDB for the project proposal entitled “Development and commercialization of fluorescence-based Rapid COVID-19 Detection Kit”. The routinely used antibody-based lateral flow Immuno chromatography test is visualized by colloidal gold-nano particles. To make the test more sensitive, the Company will be using fluorescence tags. TDB has sanctioned a Grant Assistance of Rs. 47.50 lakh out of Total Project Cost of Rs. 100.00 lakh to M/s Medzome Life Sciencez, New Delhi vide Grant Agreement dated 09.07.2020
- M/s Advance Mechanical Services Private Limited, Bangalore signed a Grant Agreement with TDB for the project proposal entitled “*Industrial IOT enabled IR Thermography-based Temperature Scanner*” to commercialize Infrared Thermography-based Temperature Scanner for Rapid Measurement and Real-Time Decision Making using an uncooled micro bolometer and video analytics platform. TDB has sanctioned a Grant assistance of Rs. 21.50 lakh out of Total Project Cost of Rs. 70.00 lakh to M/s Advance Mechanical Services Private limited, Bangalore vide Grant Agreement dated 04.09.2020
- M/s Cocoslabs Innovation Solutions Private Limited, Bangalore signed a Loan Agreement with TDB for the project proposal entitled “*Advanced video analytics for low-cost thermal cameras to identify persons with abnormal body temperature in public places*” to commercialize indigenously developed video analytics platform, providing real-time alerts and analytics using the feeds of the CCTV surveillance cameras thereby making the regular surveillance cameras intelligent for rapid fever detection to identify the abnormal body temperature in public places. TDB has sanctioned a Loan assistance of Rs. 275.00 lakh out of Total Project Cost of Rs. 590.94 lakh to M/s Cocoslabs Innovation Solutions Private Limited vide Loan Agreement dated 23.09.2020.
- M/s Nanoclean Global Pvt. Ltd., New Delhi, signed a Grant Agreement with TDB for the project proposal entitled “*Nasomask Automatic N95 Production Machine*”. The company is in process of making N95 masks that would also incorporate nanofibers and silver nanoparticles which they say can enhance the efficacy of the present N95 masks. TDB has sanctioned a grant assistance of Rs. 50.00 lakh against the total project cost of Rs. 153.65 lakh vide Grant Agreement dated 24.11.2020.
- M/s Evobi Automations Pvt. Ltd., Bangalore signed a Grant Agreement with TDB for the project proposal entitled “*Portable Ultra-Violet based Box Sterilizer & Modular Movable Ultra-Violet based Indoor Room Sterilizer*”. The company has developed Ultraviolet Sterilizers in two different models, Portable Model and Movable model. TDB has sanctioned a Grant assistance of Rs. 15.00 lakh out of Total Project Cost of Rs. 35.50 lakh to M/s Evobi Automations Pvt. Ltd, Bangalore vide Grant Agreement dated 25.09.2020.

Other Agreements Signed during 2020-21

M/s QuNu Labs Private Limited, Bangalore signed a Loan Agreement with TDB for the project proposal entitled “*Commercialization of QuNu’s Quantum Technology Security Products*”. QuNu Labs Private Ltd (QuNu) is in the Quantum Security Technology space, engaged in the development of security products based on quantum technologies. The company provides commercial solutions whose security is assured by laws of quantum mechanics. In particular, QKD (Quantum Key distribution) is a technology that offers protection against quantum hackers. TDB has sanctioned a Loan assistance of Rs. 280.00 lakh out of Total Project Cost of Rs. 586.00 lakh to M/s QuNu Labs Private Limited, Bangalore vide Loan Agreement dated 28.08.2020.

Participation in National Conference / Seminars/ Other Events

- **FICCI-TDB Webinar on Funding Opportunities for Start-ups/SMEs for Indigenous Technology Commercialization April 28, 2020**

Technology Development Board and The Federation of Indian Chambers of Commerce & Industry (FICCI) organised a webinar on “Funding Opportunities for Start-ups/SMEs for Indigenous Technology Commercialization”, on April 28,2020.



Fig FICCI-TDB Webinar on Funding Opportunities for Start-ups/SMEs for Indigenous Technology Commercialization April 28, 2020

- **Digital Conference “RE-START “on National Technology Day May11, 2020:** Technology Development Board (TDB) and Confederation of Indian Industry (CII) jointly organized a Digital Conference “RE-START” on the occasion of **National Technology Day**. The digital conference “RE-START (**Reboot the Economy through Science, Technology and Research Translations**)” was addressed by hon’ble Union Minister of Science & Technology, Earth Sciences and Health & Family Welfare, Dr. Harsh Vardhan. The programme also included special addresses by Dr V. K. Saraswat, Member, NITI Aayog; Prof. K. Vijay Raghavan, Principal Scientific Advisor to Government of India;

Dr.Saumya Swaminathan, Chief Scientist, World Health Organization; Prof. Ashutosh Sharma, DST Secretary; Dr Renu Swarup, Secretary, Department of Biotechnology, Dr Shekhar C. Mande, DG, CSIR. H.E. Mr Vincenzo de Luca, Ambassador of Italy to India also delivered special addresses in various sessions.



Fig. Inauguration of Digital Conference “RE-START “on National Technology Day May11, 2020

Apart from the digital conference, a virtual exposition with companies whose technologies have been supported by TDB was available through a digital B2B lounge, showcasing their products.



Fig. Virtual Exposition by Companies

- Innovation & Intelligent Healthcare Summit September 15-16, 2020: ET Government and ET Health World organized a two-day virtual global summit ‘Innovation & Intelligent Healthcare Summit’ on September 15-16, 2020 with Technology Development Board as a support partner. This virtual summit was focussed on the emerging technologies, including Artificial Intelligence and National Digital Health Blueprint to strengthen the healthcare delivery systems countrywide. Dr. Neeraj Sharma, Secretary TDB delivered the keynote address.

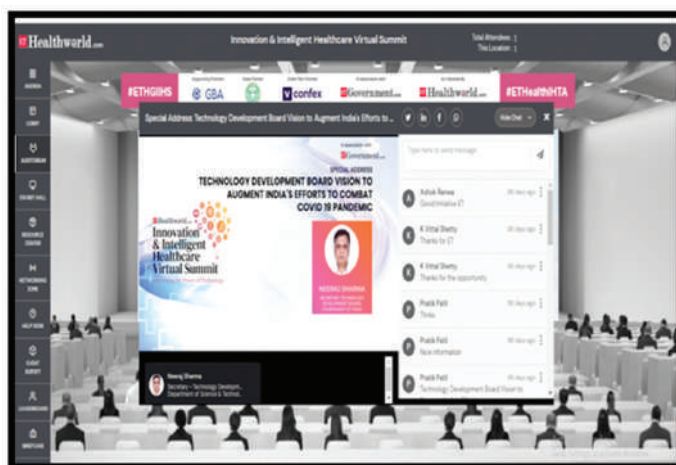

Fig. Innovation & Intelligent Healthcare Summit

- International Conference on Waste to Worth October 30, 2020:** Confederation of India Industry (CII) in association with Technology Development Board, GoI and SBM, Ministry of Housing and Urban Affairs, GoI, organized the **International Conference on Waste to Worth on October 30, 2020**, towards encouraging better waste management across the country. The theme of the conference was 'Achieving circular economy through innovative 3R techniques'. Dr. Neeraj Sharma, Secretary, Technology Development Board, GoI, highlighted the importance and need of waste management technologies in India.

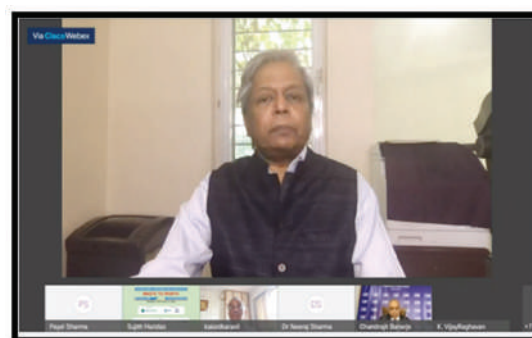

Fig. International Conference on Waste to Worth October 30, 2020

- DST-CII India-Portugal Technology Summit. December 07-09, 2020:** The 26th DST- CII Technology Summit was organised by the Department of Science & Technology (DST), Government of India, and Confederation of Indian Industry (CII) during 7th – 9th December 2020. Dr. Harsh Vardhan, Hon'ble Minister of Science & Technology, Health and Family Welfare and Earth Sciences, Government of India, inaugurated the summit and the digital exhibition on 7th December 2020. The focus themes of the summit are Watertech,

Agritech, Healthtech, Energy, Climate Change, IT, ICT, Advanced Technologies, Start-ups & Innovation and Space-Ocean Interactions.

Professor Ashutosh Sharma, Secretary DST& Chairperson TDB, highlighted that DST-CII Technology Summit has served as a platform to forge and strengthen bilateral partnerships, led to the formation of new joint ventures, and created new avenues for collaboration to boost trade and investment between the two countries, at the curtain raiser event of India Portugal Technology Summit 2020

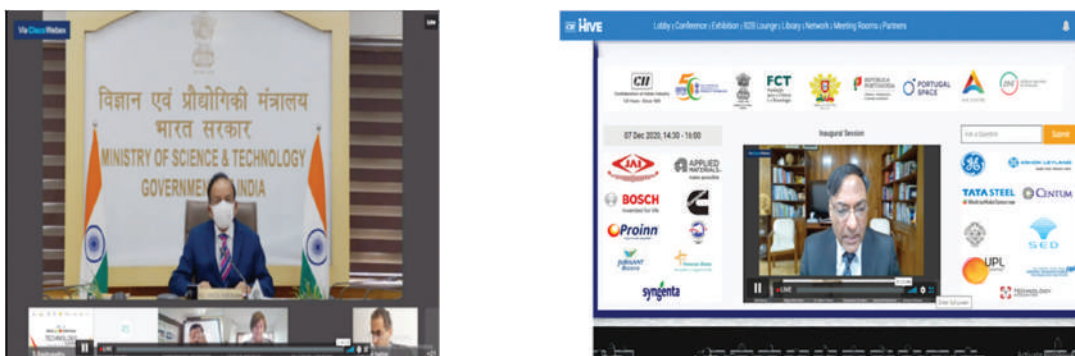

Fig. 26th DST-CII India-Portugal Technology Summit.

- Pre-Event of IISF 2020, December 10, 2020: The 6th edition of India International Science Festival (IISF)-2020 is being organized by the Ministry of Science & Technology, Ministry of Earth Sciences and Ministry of Health & Family welfare in association with Vijnana Bharati (VIBHA) during 22-25 December 2020 at New Delhi in virtual mode. “Self-Reliant India through Entrepreneurship Development in Waste Management”, jointly organised by TDB, IIWM and NEERI. A ‘Pre-Event of IISF 2020’ was organised on December 10, 2020, jointly coordinated by CSIR-NEERI and International Institute of Waste Management (IIWM), Bangalore and TDB on the theme – “Self-Reliant India through Entrepreneurship Development in Waste Management”.

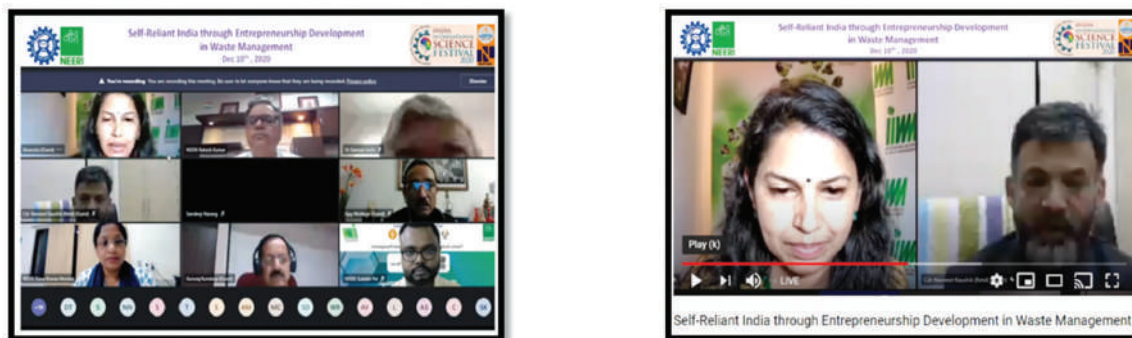

Fig. Pre-Event of IISF 2020- Self-Reliant India through Entrepreneurship Development in Waste Management

STRENGTHENING SURVEY AND MAPPING ACTIVITY

8.1 Survey of India (SOI)

Survey of India (SOI) is the National Mapping Agency (NMA) of the country and holds the responsibility to ensure that the country's domain is surveyed and mapped suitably. SOI provides topographical base maps on 1:25K/50K/250K scales to cater for the Security and developmental needs of Geo-Spatial Data for socio-economic developmental activities, conservation of natural resources, planning for disaster mitigation, expeditious infrastructure development works etc. NMP-2005 mandates SOI to create, develop and maintain National Topographic Data base (NTDB) in digital and analogue forms conforming to the national standards to meet above objectives.

Survey of India (SOI) also acts as an adviser to the Govt. of India on all survey related matters, viz., Geodesy, Photogrammetry, Mapping & Map reproduction etc. To fulfill the above responsibility SOI carried out the following activities during 2020-21.

Technical Activities in Survey of India

Departmental Activities

8.1.1 High Resolution National Topographical Data Base (HRNTDB)

With the rapid development and industrialization in the country, there is a tremendous pressure on the resources which makes planning & utilization of resources more challenging. Effective planning for the development requires accurate resource mapping at optimum resolution. Survey of India has undertaken preparation of HRNTDB for the entire country by using High Resolution Satellite Imageries (HRSI) to cater for accurate high resolution data requirements/demands from various users and organisations.

The following activities are being carried out for generation of HRNTDB:

- Data Acquisition using professional Survey Grade Drones/procurement of HRSI
- Ground Control Provision (GCPs)/ High Precision Levelling
- Geo-referencing of High Resolution Satellite Imagery (HRSI)/Data Processing

- Feature Extraction
- Ground Validation
- Establishment of Continuously Operating Reference Stations (CORS)
- Geoid Model Development
- Preparation & updation of Administrative Boundary Database
- Toponymy (Place Names)

Achievements

HRNTDB:

- HRSI procured = 3,65,907 Sq.Km
- GCP = 3172 points
- Geo-referenced = 2,76,136 Sq.km
- Feature Extraction = 68,435 Sq.Km
- Ground validation = 5440 Sq.km
- Final data preparation = 63 sheets on 1:10,000 scale

8.1.2 Defence Series Maps (DSM)

DSM sheets/maps being distributed to Army Formations.

DSM on 1:50K scale		DSM on 1:250K scale	
Printing (Maps)	Reprinting (Maps)	Printing (Maps)	Reprinting (Maps)
4838	1665	330	154

8.1.3 Administrative Boundary Database

Administrative boundaries database comprises data of the administrative set-ups across districts & states in the country. First cycle of preparing ABDB data up to village level had been completed in the past as this layer is an important component of NTDB also, however the next cycle of preparing latest up-to-date ABDB data is under process. 394 Districts completed and data uploaded on G2G Portal <https://g2g.indiamaps.gov.in>.

Toponymy (Place names)

National Map Policy (NMP) - 2005 mandates Survey of India to prepare Toponymy (Place Name) data layer as one of the fundamental dataset. Toponymy layer comprises standardised

Geographical names as per Topographical Maps of the country. Place name data as collected during field data collection is used while preparing Toponymy data layer. Sol has generated the Toponymy layer in 10 languages - English/ Hindi/Bengali/Gujarati/ Kannada/Telugu/ Malayalam/ Tamil/ Punjabi and Marathi languages and the same has been made available for public in Sol public portal i.e. www.indiamaps.gov.in.

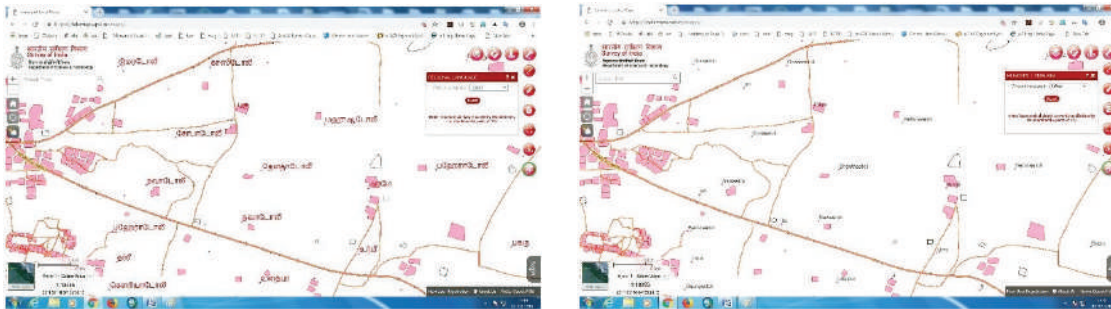

8.1.4 Geoid Model Development

Geoid Model Development for the states of Uttar Pradesh, Uttarakhand, West Bengal, Bihar and Jharkhand is completed and for the rest of the country is under progress. 3643 Linear km High Precision levelling has been completed and Gravity Observation completed on 1433 stations.

8.1.5 CORS Network:

Establishment of CORS network in the states of Uttarakhand and Uttar Pradesh is completed & for the state of Karnataka, Punjab, Rajasthan and Haryana is Under progress.

8.1.6 International Boundary:

Joint meeting of survey team of India and Pakistan was held on 4th Nov 2020 at JCP, Attari (Indian side) to discuss/review the progress of Joint demarcation carried out at Indo-Pakistan boundary (Punjab sector) during 2019-20. Sol has started field activities in the Punjab sector from 25 November, 2020.

8.1.7 Sahyog App:

Survey of India (Sol) has developed a Mobile “सहयोग “(Sahyog) for its users viz., Government (Centre/State) departments, Organisations, Institutions, Govt employees, Academic institutions, Students and citizens of India, to voluntarily support and contribute in preparing, updating and enriching the national database of the country.

Data collected using “सहयोग “application is being used for creating various applications for everyone’s usage and would facilitate building of our own Indian dataset. Our mission is to ensure that India’s data remains inside India and utilized for the benefit of the people of India.

The Sahyog application has been customized to collect AP town planning data and Panchayat data and the app is available in **Telugu** language also especially for the AP resurvey project.

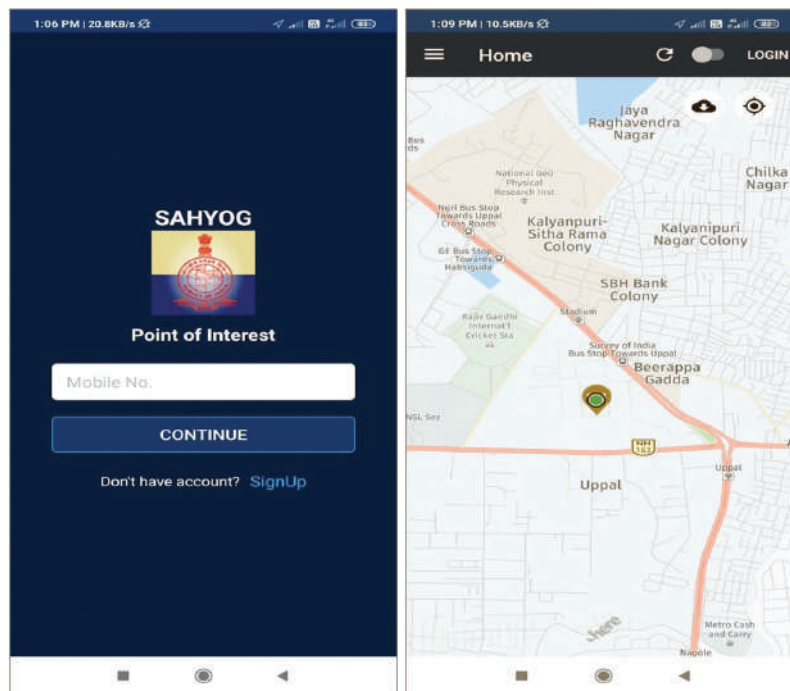

8.1.8 MTR application “Manchitra” (<http://soinakshe.uk.gov.in>):

Developed by SOI and launched on 14 Dec, 2019 to facilitate the dissemination of free .pdf maps by Indian Citizens through “Manchitra” application based on aadhar authentication. Apart from free .pdf maps, SOI also facilitates Indian citizens to buy maps in other formats (DGN, DEM, ARC, SHAPEFILE, GEOTIFF) through MTR Application. User can order and make payment online through NTRP Portal (Bharatkosh). 518782 SOI Maps have been downloaded from Manchitra portal by Indian citizens till 05 January, 2021.

8.1.9 Survey of India Portal:

SOI as a National Mapping Agency (NMA) has developed a web – based Geo- Portal offering NTDB as service to cater for Government to citizen (G2C) and Government to Government (G2G) needs and applications or information systems. This Geo- Portal has been developed in compliance to all applicable Government policies and guidelines on 11.05.2018

a. SOI Public Portal G2C (www.indiamaps.gov.in)

Portal is being monitored for necessary rectification of data and services. Nodal officers have been nominated by all SOI offices for accessing the portal and giving feedback fortnightly. Based on the feedback data and service is being continuously improved.

b. G2G Portal (<https://g2g.indiamaps.gov.in>)

SOI G2G Portal was developed and launched for giving authorized access to all government agencies. SOI has informed central government agencies including Defence forces and paramilitary forces and other related organizations about the utility of SOI portals through D.O letters. A nodal officer has been nominated for user management of G2G portal and user access is being provided to all Government agencies, Defence forces and paramilitary forces based on their request. Credentials have been generated for 717 Government users till 05 January, 2021.

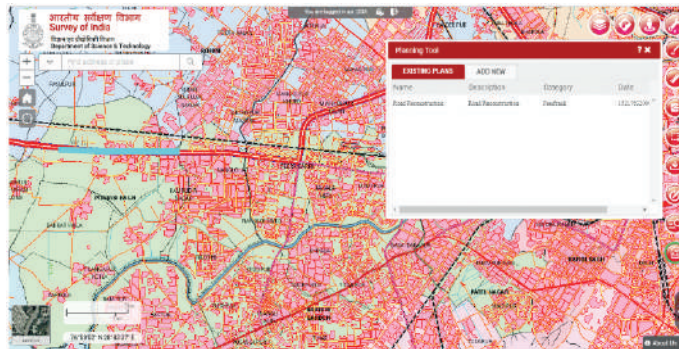

8.1.10 Spelling of Geographical names

New names / Change names request received for 85 Railway Stations, 32 places and 21 Islands names were processed for Standardised /Romanized spelling as per Indian System of Transliteration. These requests are duly verified in the field by State Geo- spatial data centres before submission to the DST/ MHA.

8.1.11 International Boundary Verification/Certification

Scrutiny of 1618 maps, certification of 1038 maps release of 89 maps and Boundary verification of 07 maps for publications (Central Govt, State Govt. & Private Agencies) carried out till 31 December, 2020.

8.1.12 Training & Capacity building

SOI is a prime mapping organization having the expertise in the field of surveying gained over two and half centuries of mapping. To maximize the benefit of knowledge, strengthening the organization and spreading the knowledge of geo-spatial technology, National Institute of Geoinformatics Science & Technology (NIGST) erstwhile Indian Institute of Surveying & Mapping (IISM), the capacity building arm of SOI, is conducting various training programmes in the field of surveying & mapping. Besides internal training, the other beneficiaries are State Government agencies, Industries & Private individuals & trainees from neighbouring Middle East and some African countries throughout the year.

No. of trainees passed out during this year

Departmental	Extra Departmental	Others	Foreigner Trainee	Total
684	664	13	-	1361

8.1.13 Extra-Departmental Projects**National Hydrology Project (NHP)**

This project is very important for national interest in which Survey of India (Sol) is one of the Central Implementation Agency in execution of National Hydrology Project (NHP). The Main objective of the World Bank assisted project is to improve the extent quality and accessibility of water resources information and to strengthen capacity of targeted water resources management institutions in India. This Project aims to improve the planning, development and management of water resources as-well-as flood forecasting and reservoir observations in real time.

Sol has been entrusted with the responsibility to generate, prepare and provide various types of Geo-spatial datasets i.e. for mapping/preparing the Digital Elevation Model (DEM) of 0.5m, 5m & 10 m for River Basin areas (plain), up to 5 km on both the sides of river and GIS ready data of SOI Topo sheets on 1: 25 K scale.

The Project is to be completed in eight years duration with two phases of four years each. In the first phase Ganga, Brahmaputra, Mahanadi, Godavari, Gandak, Kosi, Narmada, Satluj etc. river basins will be completed by 2021.



Fig. Data generation work for NHP

Achievements

a) Generation of GIS data & 3-5 m Digital Elevation Model (DEM) for approx. 800,000 Sq.Km:

- Provision of GCPs completed 90% for mono HRSI and 83% for stereo HRSI.

- Feature Extraction of 690 sheets (1,17,300 sq.km) on 1:25K scale compiled
- Geo referencing of Mono-High Resolution Satellite Imagery = 70% Completed

b) Generation of 0.5 m Digital Elevation Model (DEM)

- Security Clearances completed.
- Aerial Data Capturing = 6285 Sq.km. completed
- DEM generation = 6285 sq. Km. completed

c) Continuously Operating Reference Stations (CORS)

- CORS network established in UP, part of Uttarakhand completed and operationalised.
- Geoid Model for part of Uttarakhand, entire Uttar Pradesh, WB, Bihar & Jharkhand completed.

National Mission for Clean Ganga (NMCG)

This project is an integrated conservation mission, approved as flagship programme by the Union Government in June 2014 to accomplish the twin objectives of

- Effective abatement of pollution
- Conservation and rejuvenation of the national river Ganga.

Objective of the Project is to generate a High Resolution DEM and GIS ready database for the part of River Ganga with the latest technology. The mapping of the main stream of river Ganga in five major states namely Uttarakhand, Uttar Pradesh, Jharkhand, Bihar and West Bengal has been proposed covering major towns and cities along the river Ganga and its tributaries in these states with an area of Two lakh fifty thousand square km. The project is under progress with various activities outsourced and procurement being made through Open e-tendering as per Government of India public procurement guidelines. To provide a major support to Ganga River basin Management by embedding GIS in different aspects of - planning and implementation at national/state/local levels; bringing GIS support in decision-making; enable a sound process of monitoring development and identifying critical hotspots. to make GIS data available at all levels and groups associated in this process – that helps bringing accountability and responsibility in policy decisions

Survey of India has been tasked for generation of High Resolution Digital Elevation Model (DEM) of 0.5 metre resolution and GIS based for the part of River Ganga covering up to 10 km extent on both sides of the river using latest Technology.

Achievements:

- **0.5 m Digital Elevation Model (DEM) and GIS ready database:**
 - ◇ LiDAR Data Acquisition 5124 Sq.km completed.
- **Geoid Model Development:**
 - ◇ UP, Bihar, Jharkhand & West Bengal completed.
- **Web Hosting & Application Development:**
- Development of customised application development under progress at GIS&RS Directorate.

Large Scale Mapping for State of Haryana:

Memorandum of Understanding (MoU) has been signed between Survey of India, Govt. of India and Revenue and Disaster Management, Govt. of Haryana on 8th March, 2019 for undertaking the large scale mapping project which include to generate up-to- date digital topographical map of entire state of Haryana for 44,212 km² area using Professional Survey Grade Unmanned Aerial Vehicle / Drone for Large Scale Mapping and field measurements, Continuous Operating Reference System (CORS) and Differential Global Positioning System(DGPS) survey.

Data acquisition (sq.km.)	Data processing (sq.km.)	Feature extraction (sq.km.)
6665	4511	275

Large Scale Mapping for State of Karnataka

Memorandum of Understanding has been signed on 28th Feb, 2019 with Revenue Department, State Govt. of Karnataka for undertaking the large scale mapping of rural and urban land and properties (nearly 51,000 km²) area using UAV/Drone. Prior to MoU a pilot project was carried out by Survey of India at Jayanagar in Bengaluru city and Ramanagar town separately.

Inauguration of Drone Survey for land parcels in Karnataka was done by Hon'ble CM of Karnataka Shri H.D. Kumaraswamy on 16th July 2018 at Ramanagar, Karnataka.

Data acquisition (sq.km.)	Data processing (sq.km.)	Feature extraction (sq.km.)
1227	1475	322

SVAMITVA:

Large scale mapping on 1:500 scale of the hitherto unmapped rural village **Aabadi areas** using Professional Survey Grade UAV/ Drone for villages across the country is being undertaken by the Ministry of Panchayati Raj (MoPR), Govt of India under *Central Sector scheme* "SVAMITVA". The scheme aims to provide an integrated property validation solution

for rural India. SVAMITVA Scheme was launched by **Hon'ble Prime Minister of India on 24th April 2020.**

Survey of India is the technology implementing agency in the project. Sol is carrying out drone survey to generate the large-scale maps & property records of village habited areas covering approx 1 lakh villages in phase I and remaining in phase II. This mapping work includes establishment of Continuous Operating Reference System (CORS) network system, Geoid model development, generation of maps (analogues and digital) and creation of GIS database.

The scheme will be undertaken as pilot project during 2020-21 for drone based mapping in 08 states viz., – Haryana, Maharashtra, Karnataka, MP, UP, Uttarakhand, Rajasthan and Punjab. Also establishment of CoRS network in the states of Punjab & Rajasthan.

Roles fixed for Survey of India under the scheme are as under:

- Establishment of CORS Network
- Drone data capturing
- Drone data processing
- Base map generation and feature extraction
- Integration of the ownership data as provided by the State department
- Field Validation.

MoU with Govt. of Uttarakhand

A MoU has been signed between Sol and the state of Uttarakhand on 03 June, 2020 for Large scale mapping of 17048 villages on 1:500 scale of the hitherto unmapped Rural abadi areas using Professional Survey Grade Unmanned Aerial Vehicle/Drone under SVAMITVA scheme.



MoU with Govt. of Uttar Pradesh

A MoU has been signed between Sol and the state of Uttar Pradesh on 08 June, 2020 for Large scale mapping of 108648 villages on 1:500 scale of the hitherto unmapped Rural abadi areas using Professional Survey Grade Unmanned Aerial Vehicle/Drone under SVAMITVA scheme.



MoU with Govt of Punjab

A MoU has been signed between Sol and the state of Punjab on 2nd July 2020, for Drone based Large Scale Mapping of 13,045 villages for the SVAMITVA scheme for Ministry of Panchayati Raj (MoPR).



MoU with Govt of Rajasthan

A MoU has been signed between Sol and the state of Rajasthan on 8th July 2020, for Drone based Large Scale Mapping of 46,543 villages for the SVAMITVA scheme of Ministry of Panchayati Raj (MoPR).

MoU with Govt. of Chhattisgarh

A MoU has been signed between Sol and the state of Chhattisgarh on 23 December, 2020 for large scale mapping using professional survey grade UAV/Drone under Svamitva scheme of Ministry of Panchayat Raj (MoPR).

Achievements

Name of states	Data acquisition (villages)	Data processing (villages)	Feature extraction (villages)	Final LPM generation (villages)
Haryana	3935	3121	2646	273
Maharastra	1757	1342	902	65
UP	7320	4344	3273	600
Uttarakhand	1569	1341	1276	50
MP	1545	1218	797	63
Karnataka	740	626	419	2
AP	5	0	0	0
Total	16871	11992	9313	1053

Other MoU Signed

MoU with Andaman and Nicobar Islands Administration through Secretary Revenue, Andaman and Nicobar Islands Administration on 27th July 2020, for Drone based Large Scale Mapping for Revenue area, degraded land and Deemed Forest area.

MoU with Govt. of Andhra Pradesh: Survey of India signed a MoU with Govt. of AP on 09 December, 2020 in the presence of Hon'ble Chief Minister of Andhra Pradesh for Resurvey of all kinds of lands including agricultural lands, Abadi (Rural village sites) and Urban habitations in the entire state of Andhra Pradesh covering an area of about 1.22 lakh sq.km. (approx. 17460 revenue villages), village sites & urban area and their extension area using professional survey grade UAV/ Drone.



MoU with Andhra Pradesh

Sol signed a MoU with Indian Institute of Technology, Kanpur: A MoU has been signed between Sol and Indian Institute of Technology, Kanpur on 31.August, 2020 for broad areas of academic and research collaboration in Geoinformatics and Geodesy. Based on the shared vision in the broad area of Geoinformatics and Geodesy, Sol and IIT, Kanpur plan to collaborate with the objective:

- Promoting, interaction in mutually beneficial R&D areas
- Providing training to Sol Officers and initiating closer academic interaction
- Facilitating academically eligible officers from Sol to pursue higher degree, e.g. DIIT, MS(R)/M Tech, PhD, at IITK.

8.2 NATMO

National Atlas and Thematic Mapping Organisation (NATMO), a Subordinate Office under the administrative control of the Union Ministry of Science & Technology (Department of Science & Technology), Government of India has a total strength of 470 employees. A large number of qualified professionals including geographers, geologists, statistician, mathematician, professionals of Geospatial technology are engaged in preparing thematic maps and atlases in this organization.

NATMO's journey started with compilation of National Atlas in Hindi by Prof. S P Chatterjee way back in the year 1956. Today, it is the pioneering organization engaged in Thematic Cartography, Atlas Cartography, Geographical Research and Training. Documentation Centre and Library, including its remote sensing archive give sufficient support and strength in every sphere of its activities. NATMO provides services not only in the field of thematic cartography and geo-spatial technology, but also to extend wide services to a good number of technocrats, professionals, research scholars, planners and students as well. NATMO library is very famous for rare books/CD, journals, topographical sheets, maps etc.

Thematic maps and atlases compiled by NATMO are popular across a large spectrum of stakeholders and also serve as the vital inputs for planning at various levels. The maps and atlases prepared by NATMO serve as visible tools to understand the changes and developments taking place in the domains of geo-environmental, political, socio-economic conditions in the country. NATMO covers almost all the themes pertaining to physical, political, economic, cultural, historical and other related environmental and societal issues that serve as the basic tools for a wide range of users including decision makers and the common public.

NATMO has a proven track record in urban mapping as well. High resolution satellite data rectified with GCPs (Ground Control Points) collected through GPS-based detailed field survey, are being used as base information for the preparation of large scale city maps. To promote tourism and related industry, maps on tourist places and routes including adventure

tourism maps, maps on national parks and wildlife sanctuaries are being prepared and updated.

The organization motivates the planners and decision makers to use maps as complimentary documents for development planning at national level, state/UT level and district and sub-district levels. District planning maps are being prepared to meet the planners' demand.

The mandate of this organization is:

- Compilation of National Atlas in English, Hindi and other regional languages with timely updation.
- Preparation of School Atlases for all boards to provide accurate and standard base information for the educational institutions.
- Preparation of State Atlases and other special atlases.
- Generation of thematic maps and standardization of thematic information.
- Mapping of natural resource assessment towards sustainable socio-economic planning at district level.
- Large-scale mapping and development of digital cartographic base for utility-based services.
- Providing geographical education and training to visually impaired and low vision society through maps and atlases.
- Management of comprehensive Geo-informatics products for the service of the Nation through web portal.
- National and International cooperation on multidisciplinary geosciences through collaborative programmes.
- Providing unrestricted map service to all sections of the society.
- Other activities entrusted through the Administrative Ministry from time to time.

8.2.1 Major Activities And Achievements During The Year 2019-20

COVID-19 Dashboard

NATMO developed a Covid-19 Dashboard (geoportal.natmo.gov.in/covid19/) for seamless updation of data and represent information categorically (Fig 1) to help in informed decision-making. The dashboard has been developed with three separate sections:

1. **Dashboard** Tab to visualise the temporal spread at different spatial levels along with on the fly depiction of rates

2. **Health Infrastructure** Tab showing dedicated Health Facilities identified by states, ICMR Test Lab locations and Blood Banks plotted on map with the option to search by city/districts
3. **Analytics** Tab (in progress) using interactive modelling with respect to location interface and other important secondary data like demography and spatial contiguity to identify the vulnerable zones.

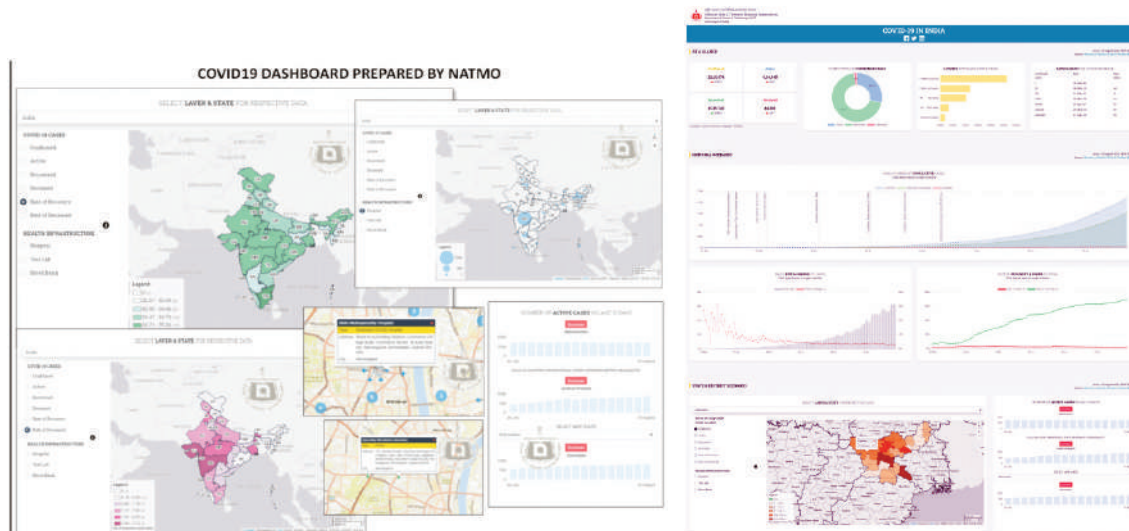

Fig. Covid-19 dashboard as appeared in NATMO Geoportal

The objective of this initiative is potential use of geospatial technology in this crisis period to visualize real-time scenarios through maps and charts. Data driven vulnerability assessment using associated socio-economic-demographic indicators across the country at varying spatial scale will provide a base for the current situation analysis, mitigation and future planning. The techno-based solution will ultimately help the administrators in more efficient and effective decision making. Further improvements have been aimed with an integrated approach among NATMO, DST, MOH&FW and other line departments.

International Collaboration

NATMO is already in collaboration with Geoinformatics and Space Development Agency (GISTDA), as part of the Science & Technology cooperation of the Government. NATMO has already completed the project of preparation of 'India-ASEAN Archaeological Atlas from Satellite Data – Connectivity of Regional Culture Finite Routes and Infinite Values'. This year, another project of preparation of 'SOCIO-ECONOMIC ATLAS OF THAILAND' has been initiated with GISTDA. Concept Note has been finalized for the project and salient themes and methodology has been fixed. Due to COVID-19 pandemic, the project work could not be progressed as per the timeline.

Extra departmental Projects:

NATMO has made a significant achievement during this year by taking up three extra departmental projects with organizations of very high repute. Details of each collaboration is as below.

- **Women Empowerment Atlas**

The main focus of the Atlas is to emphasize empowerment of women in India from the perspective of Science and Technology with related themes viz., Women Empowerment, Education, Health, Livelihood etc.

Women scientists are participating in different fields of science and Technology, in the department of DST, DBT, ICMR and ICAR. Emphasis is given on the data provided by the National Science and Technology Management Information System (NSTMIS) of the Department of Science and Technology (DST), Government of India. While analysing women empowerment (Fig 2) it has been observed that the gender parity index is prevalent in different sectors like Higher education, demographic pattern, decision making sectors which has been elaborated in the atlas. In Higher education the relative access of females and comparison with males has been analysed. Infant and child mortality is relevant to a demographic assessment of the population, and is an important indicator of the country's socio-economic development and quality of life. These estimates can also help identify children who may be at higher risk of death and lead to strategies to reduce this risk, such as promoting birth spacing. It focuses on women's decision making and data for specific indicators are also presented for men. Comparisons of indicators for women and men help to identify gender disparities and provide context for women's empowerment. Health maps provide essential data on health and family welfare, as well as data on emerging issues in those areas. It is designed to provide vital estimates of the prevalence of malnutrition, anaemia, hypertension, HIV, and high blood pressure and glucose levels.

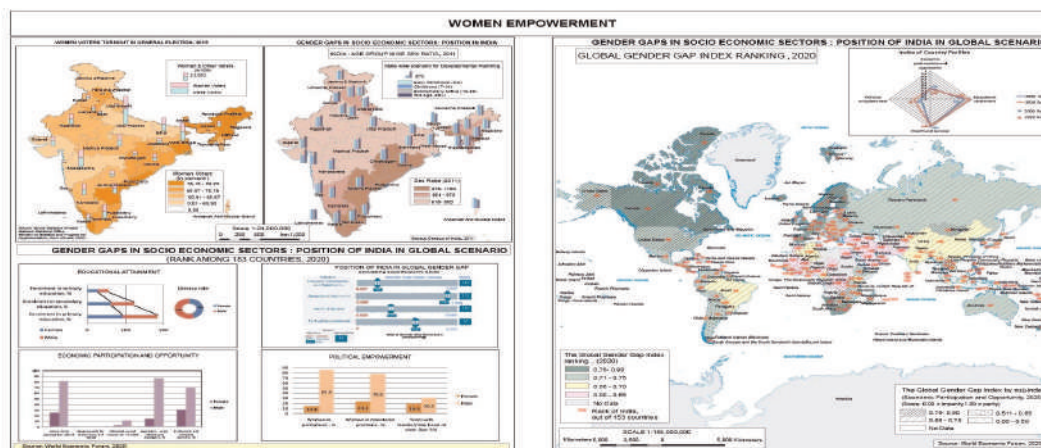

Fig . Gender gap scenario and position of India in respect to world

- **Large Scale Mapping: Resource mapping for Livelihood Assessment**

Resource mapping for Mahishmari village of Jaynagar Block-II, District South 24 Parganas, West Bengal as a consultative program with Vivekananda Institute of Biotechnology (VIB), Nimpith, West Bengal (Fig 3a and 3b)

Effective use of geospatial information and technology has become the platform of solution for different environmental and developmental challenges. But due to absence of high-resolution map data in appropriate forms, many planning and development programme are lagging behind in our country.

NATMO has completed surveying and prepared 42 large-scale maps (1:4000 scale) on principal assets of the villages to facilitate micro-level planning like irrigation, agriculture, Village Information System etc. using its own database and methodology for analysis for scientific and technological intervention.



Fig. Official discussion between NATMO and VIB team

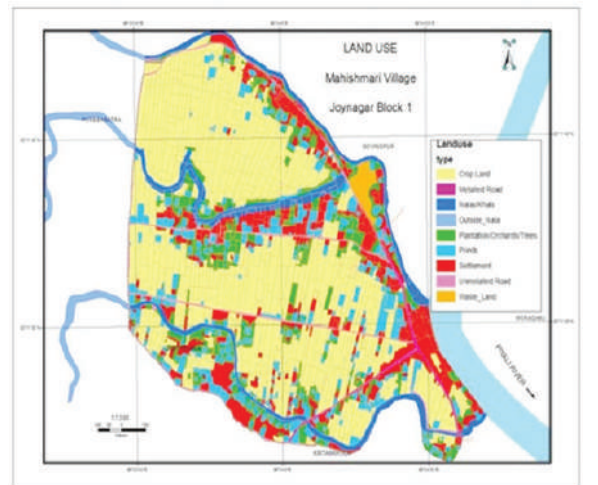

Fig. Land use map of Mahishmari village

- **Irrigation Atlas of India-Updated version**

The first ever Irrigation Atlas of the Country was published by NATMO in the year 1979 in collaboration with Ministry of Agriculture, Government of India. This project has been taken up to update the Irrigation Project area in consultation with Central Water Commission, Government of India. About 23 maps (Fig 4) have prepared which will be published within March 2021.

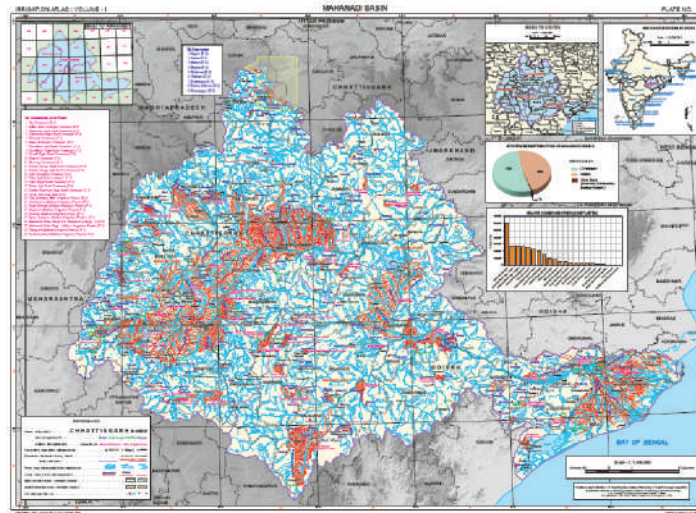

Fig. Mahanadi Basin of India

8.2.2 Brief Account of the ongoing Institute Projects

1. Technology Development Programmes

A) NATMO'S Own Geo-Portal Development

Initiative

Geospatial data generated in pieces over the years under several projects is now to be made available in the public domain for 24x7 access by the users. Keeping this objective in view NATMO has taken up the initiative to set-up its own Geo-Portal.

Achievement

The Project of setting-up of Enterprise Geo-portal for NATMO was initiated in the last quarter of 2018-19. During the current year a tremendous progress has been made in spite of the COVID-19 pandemic situation. A brief overview of the progress made in this area is summarised as under.

Creation of Web Map Service (WMS) and Web Feature Service (WFS) of 49 theme layers of the National School Atlas has been completed. The Map Service is now made available online. WMS service also created for Goa State Atlas. WMS services created for District Planning Map Series that include Mandsur, Nadia, Puruliya. 276 DPMS Maps in raster format are already published in geo-portal. WMS service created for Golden Map Series as well which include Bidhanagar, Mahakashi, Bardhaman. Apart from these PDF version of 24 GMS maps of various cities are also uploaded in the Portal.

Several e-books/atlasses are also published which are all available in the geo-portal.

Augmentation of Data Centre infrastructure has been one of the top priorities. Accordingly, the existing infrastructure has been enhanced with Routers and L-3 Switches, Firewall, Internet Leased Line connectivity. Other activities of modernisation include installation of Video Conferencing system. Webex installation for online training, events and meetings is also underway.



Fig. NATMO Data Centre

B) Golden Map Service (GMS):

Initiative

On the occasion of Golden Jubilee Celebration of NATMO, this project was taken up with the aim to prepare a large-scale map of the cities and towns of the country consisting of minute level information relevant to the available utilities, communication, and land use. This map is very much useful for the planners, architects, tourists and the citizens as well.

Objective:

Primary: To provide location maps of any site of the country in Black and white on web either by place-names or by Geographical co-ordinates.

Secondary: To provide route maps between two points in the country.

Tertiary : To provide a basis for a variety of social, economic, administrative operations related to elections, crime, rural marketing, relief and supply etc.

Achievement:

In the current year, one GMS project of Puducherry has been completed. Due to COVID-19

Pandemic fieldwork could not be done for checking of Ground Control Points (GCP) to publish the maps of Amritsar, Noida and Gurugram.

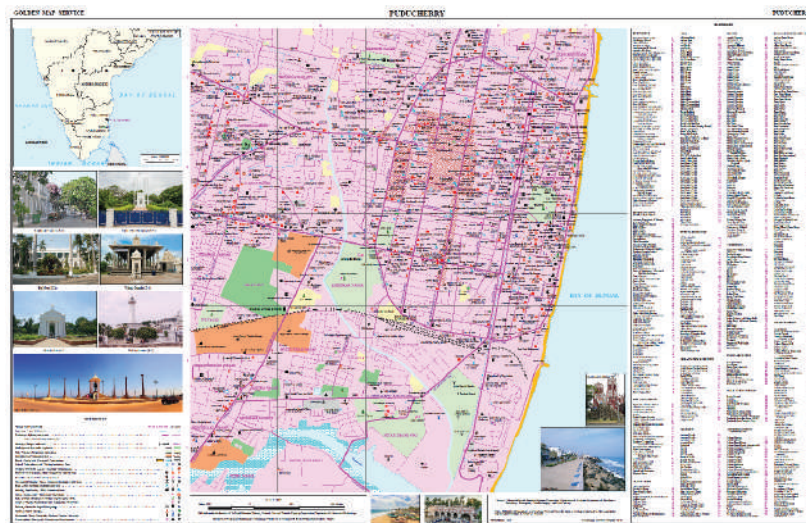

Fig. GIS Map of Puducherry

C) DISTRICT PLANNING MAP SERIES (DPMS)

Initiative:

As per the decision of DCUSPC, NATMO has been assigned this project by DST. Though initially this project was shared between NATMO and Survey of India and later on NATMO has been assigned this project solely.

Objective:

To provide a ready-reckoner to the planners, researchers, students in respect of complete geographical, geological, geomorphological, demographic, cultural information and features along with administrative boundary, blocks, specialty, etc. of a particular district both in paper format and in digitized format both in Hindi and English.

Achievement:

NATMO has almost completed the project and maps of 279 districts have already been published for the users. Digital version of the maps is also going on in the final stage and will be published for the users very soon. However, revision and updation work on account of formation of new districts, are in progress along with the rest project. This year, due COVID-19 pandemic, the progress of the work is not good as because the fieldwork could not be done. However, seven DPMS maps have been completed this year . Work on 10 maps are going on.

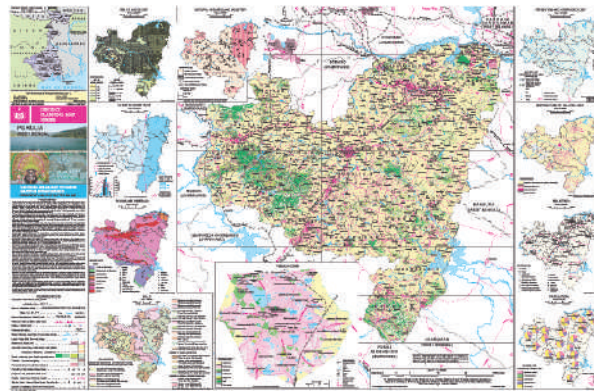

Fig. DPMS Map of Puruliya District, West Bengal

D) Thematic Map

NATMO has completed thematic maps on Shaktipith and on Hinduism at 1:6M scale

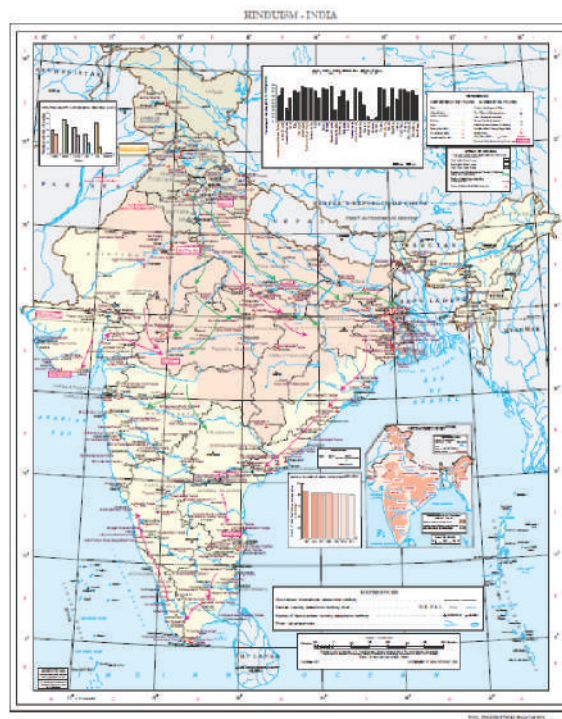

Fig Shaktipith and Hinduism Map of India

E) THEMATIC ATLAS

This year NATMO has come up with the thematic atlas on cultural heritage atlas of India containing 37 chapters on various themes of Religion and Philosophy of ancient India,

Medieval Devotionalism, Social Reform of Modern Period and Art & Culture of Indian origin. This atlas will be published within March 2021.

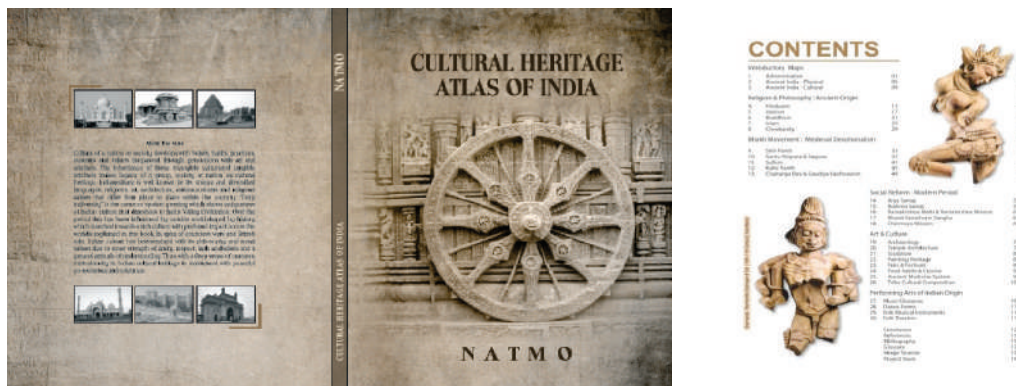

Fig. Cover page & contents of Cultural Heritage Atlas of India

F) NATIONAL ATLAS OF INDIA

Initiative:

In the year 1956, the then Prime Minister of India, Pandit Jawaharlal Nehru approved the formation of National Atlas & Thematic Mapping Organisation (then it was National Atlas Organisation) and granted the '**National Atlas Project**' to NATMO. Hence, National Atlas is the flagship publication of NATMO. Accordingly, 'भारत राष्ट्रीय एटलस' first published in 1957 and its English Version, 'National Atlas of India' was published in 1986. Since then, this publication is being updated and revised keeping pace with the administrative changes in respect of states, districts etc., along with conversion in digital mode is under process.

Objectives

- To have India's National Atlas like the other countries of the world.
- To depict the country in respect of its geology, geography, geomorphology, demography, culture, administration, etc. in thematic map form.

Achievement

National Atlas of India, both in English and in Hindi version, has been appreciated by the users of every corner. It is for the vertical demand of the users, NATMO is still publishing the editions of the Atlas till today and regular updation and revision of the same is going on. Revision of theme maps is a part of our mandate. Due to the pandemic situation, ground data collection could not be done and hence, progress is slow. Considering the situation, the National Atlas of one comprehensive volume will be published to commemorate the 75th year of Indian independence.

G) ATLAS FOR VISUALLY IMPAIRED (BRAILLE MAP)

Initiative

The visually challenged persons cannot use the traditional maps or atlases. Keeping the issue in mind, NATMO initiated the project to prepare Atlas for visually impaired in Braille script. The Department of Science & Technology, Govt. of India provided financial support and approval for the same. And NATMO became the first ever in the country to publish 'Atlas for Visually Impaired' in Braille script, depicting all the continents and with special emphasis on India.

Objective

To disperse the technological development amongst the people who cannot get it due to their physical disability, i.e. blindness. Publishing Maps and Atlases in Braille Script will definitely provide the utility of maps to the visually challenged person.

Achievement

'Atlas for Visually Impaired' has become an eye opener for the visually impaired students and several requests from all the states are being received by NATMO. This year Atlas for Visually Impaired published in Hindi on World Braille Day at Ramakrishna Mission, Narendrapur, West Bengal.

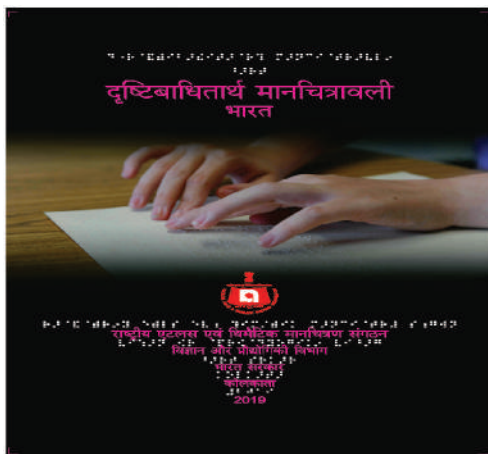

Fig. Braille Atlas in Hindi



Fig. Releasing of Braille Map and Atlas (in Hindi)

Similarly, NATMO has started preparing Braille atlas in different regional languages due to demand from different states schools and accordingly braille atlases are being prepared in Assamese, Bengali, Oriya, Telugu, Tamil and Malayalam.

F. Monographs

Monographs are published by NATMO on specific topics. NATMO's monographs on

Geomorphology, Lakshadweep, are popular among the series. Achievement: This year NATMO has completed one monograph on Delhi: City of cities- A Geo-historical Review.

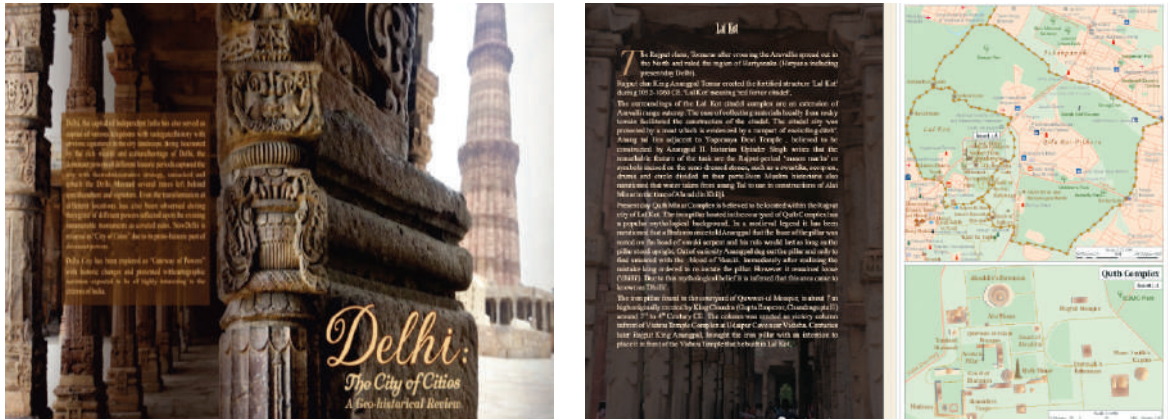

Fig. Monograph on Delhi City

Shaktipithas of India, another monograph on the historical review of the *Shaktipithas* that elaborates the historical events connected to Hindu religion through various thematic maps.

G. 3 D Mapping: NATMO has initiated this project during the F.Y. 2019-2020. One map of Rashtriya Atlas Bhavan Campus has been prepared using advanced 3D technology. The methodology of this project involves integration of data captured from highly specialized mapping technology tools like GPS, UAV, Photogrammetry Remote sensing and GIS.

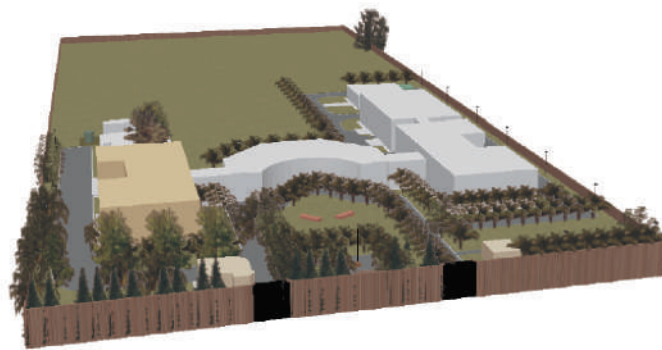

Fig. View of Rashtriya Atlas Bhavan at Salt Lake

Conclusion

NATMO as a pioneer mapping organisation has been playing a substantial role in contributing to nation development. NATMO's achievements are just the open proof of its integrity and commitment to societal needs. The successful set-up of the data centre in NATMO is going to be a paradigm shift in the activities and deliverables from this organisation in providing more and better map services in the coming years.

ADMINISTRATION

The administration and finance divisions of the Department continued to provide support and necessary administrative decisions for smooth functioning of the Department as well as its subordinate offices.

9.1 General Administration

(i) Celebration of Constitution Day

To commemorate the adoption of the Constitution of India by the Constituent Assembly on 26th November, 1949, the Department of Science & Technology had arranged yearlong programmes for celebration of the Constitution Day. The following activities were held in the Department:

- (a) Constitution Day was celebrated on 26th November, 2020. The Hon'ble President of India lead the reading of the Preamble of the Constitution at 11 AM from the Rashtrapati Bhawan which was broadcast live. Secretary, DST and a large number of Scientists, officers and staff of Department of Science & Technology and Department of Scientific & Industrial Research joined the Hon'ble President in reading of the Preamble. The Constitution Day was also celebrated in subordinate offices and Autonomous Institutes/ Statutory Bodies under the administrative control of DST.



Constitution Day celebrations in Department of Science & Technology

- (b) Constitution Walls have been prepared with posters of Preamble and Fundamental Duties of the Constitution at four prominent places in the Department.
- (c) The Department had organised Essay Competitions in Hindi and English on 30.07.2020

and 31.08.2020 on the Fundamental Duties, enshrined in Article 51A of the Constitution of India. Winners of the Essay Competitions were handed over Certificates, signed by Secretary, DST, after following social distancing norms.



Essay Competition held on 30.7.2020 in Raman Auditorium

(ii) Measures to contain impact of COVID-19 in Technology Bhawan

The month of March 2020 witnessed confirmation of Novel Coronavirus (COVID-19) cases in more than 90 countries, including India. The World Health Organisation also declared COVID-19 as a pandemic. For mitigating the impact of COVID-19 outbreak, several measures were taken in the Technology Bhawan premises of the Department of Science & Technology (DST).

Several posters on preventive measures on COVID-19 have been displayed in Technology Bhawan premises of the Department. In pursuance of guidelines of Department of Personnel & Training (DOPT), office specific guidelines were issued for maintenance of social distances in the office premises, limited attendance of officers and staff on a particular working day, shifting to online and virtual meetings in place of physical meetings and switching to online e office mode for office work, etc.

Following the guidelines of Health & Family Welfare, orders are issued for work from home of 14 days for the officers/ staff who come in direct contact with a COVID positive case, diagnosed in the Department. The other officers/ staff who share the same Room/ Corridor of the COVID positive case are also advised to work from home for 48 hours for conducting sanitization activities in such Rooms/ Corridors. To facilitate working from home, the officers were provided with VPN access through NIC for accessing e-office portal from home.

As Delhi NCR witnessed a surge in COVID-19 positive cases and the pandemic was affecting several employees of the Department and their family members, a COVID Response Group was constituted to provide support to the employees with a coordinated approach at the Department level.

In pursuance of the guidelines of the Government to contain spread of COVID in offices and to provide a safe working environment to all officers/ Scientists/ staff of the Department, several preventive measures were taken. Ensured thermal screening of every employee and visitor at the main entrance of the Technology Bhawan using IR Thermometer to identify any potential infected case of COVID. Several sanitizer dispensers have been installed at the entrance of the building and other common areas.

Instructions were issued to all the employees to ensure that they wear masks at all times in the premises. Face covers/masks & Hand Sanitizers were also provided to all officers/ Sections in the Department. Frequency of mopping/ cleaning activities increased to ensure complete and regular disinfection of entrance gates, meetings rooms/ conference halls/ open areas/ corridors, washrooms and all other frequently touched surfaces.

In view of the above measures, the normal functioning of the Department has been maintained throughout the post COVID period.

(iii) Roof Top Solar Power Plant

In view of the enhanced focus of the Government for providing energy security and tapping the renewable energy sources, a roof top solar plant (350 KWp) was commissioned on 07 January, 2019 in Technology Bhavan premises of Department of Science & Technology. Since installation, the Roof Top Solar Power Plant has generated a total of 6,99,984 electrical units (KWH) with corresponding savings of Rs.59,50,000/- + applicable taxes & other charges.

9.2 Staff Position

Group A						
Category	General	SC	ST	OBC	PH	Total
Scientific	85	6	3	7	4	105
Non-Scientific	35	13	1	7	0	56
Group B						
Scientific	8	1	0	3	1	13
Non-Scientific	59	3	7	16	2	87
Group C						
Scientific	0	0	0	0	0	0
Non-Scientific	58	53	9	27	4	151

9.3 Parliamentary work

The Parliament Unit serves as central coordinating point for all parliamentary work of the Department. It is assigned with the responsibility of handling entire parliamentary work of the Department, viz. preparing answers to Parliament Questions, fulfilling assurances, analyzing reports of Parliamentary Committees etc. It ensures that the parliamentary work pertaining to the Department of Science & Technology is accomplished as per the prescribed schedule and procedures. The Unit maintains liaison with the Ministry of Parliamentary Affairs, Secretariats

of Lok Sabha/ Rajya Sabha, other Ministries/Departments (including Scientific Departments) with a view to fully discharge the parliamentary obligations of the Department of Science & Technology. The Unit also coordinates the visits of the Parliamentary Committees to various scientific institutions which are under the administrative control of this Department.

9.4 Implementation of official Language Policy

The Department of Science and Technology continued to make concerted efforts to promote the use of Hindi in official work and to ensure compliance with the provisions of the Official Language Act, 1963 as amended in 1967 and Rules 1976 framed thereunder as also the various orders / instructions issued by the Department of Official Language from time to time with a view to ensure proper implementation of the Official Language Policy of the Government.

DST has a full - fledged Hindi Section consisting of a Joint Director (O.L.) assisted by an Assistant Director (O.L.) and other supporting staff which caters to the need of the Department of Science & Technology. Besides monitoring the implementation of the Official Language Policy and the Annual Programme, Hindi Section arranges for in - service training of the staff in Hindi Language, Hindi Typewriting and Hindi Stenography. It also undertakes translation of the material received from various Sections / Desks of the Department from English into Hindi and vice - versa as per need.

For promotion of use of Hindi in this Department and to create conducive environment for the officials to work more in Hindi various programmes are being undertaken in FY 1920-21

All documents coming under Section 3(3) of the official language Act, 1963 like general orders, notification, cabinet note, annual report and any paper which is to be laid in the parliament, were issued bilingually in both Hindi and English. Letters received in Hindi were invariably replied to in Hindi.

During the year, quarterly meetings of Departmental Official Language Implementation Committee were organized. Likewise, Hindi workshops were organized to encourage the officers / staff of the department to conduct their maximum work in Hindi.

Hindi Advisory Committee is in the process of reconstitution.

Celebration of Hindi Pakhwara: Hindi Pakhwara was organized from **11 to 22** September, **2020** in DST, Ministry of Science and Technology. Various Hindi competitions were organized and the successful participants were given cash awards and certificates. The closing ceremony of the Pakhwada was organized online using Microsoft Teams in which prize winner recited their winning poems. A '*Kavi Samelan*' for officers and staff of DST was organized in Raman Auditorium to promote the use of Hind Hindi.

9.5 Right to Information

The Right to Information Act, 2005 was enacted by the Government of India to promote

transparency and accountability in its functioning.

Department of Science and Technology has been implementing the RTI Act in letter and spirit.

To ensure transparency in its functioning, DST has been regularly making suo-moto disclosures on its web-site, as required under Section 4(1)(b) of the RTI Act, 2005.

During the period from 1st April, 2020 to 13th January, 2021, a total of 646 RTI applications and 56 First Appeals were received by the Department and out of which 586 RTI applications and 52 Appeals have been disposed of as per the provisions of RTI Act, 2005 till date.

9.6 Public Grievances

Grievance redress mechanism is an instrument to gauge and measure efficiency and effectiveness of an organisation as it provides important feedback on its working. An essential pre-requisite to make the public service delivery system more accountable and responsive is to have a robust public grievance redress and monitoring mechanism.

Department of Science and Technology has made concerted efforts to redress the grievances received from its stakeholders and the public at large.

A total of 1274 public grievances were received by the Department during the period from 1st April, 2020 to 13th January, 2021. A total of 1292 grievances has been disposed of by 13th January, 2020 including backlog of 93 grievances.

9.7 Vigilance

The Vigilance Unit of the Department of Science & Technology (DST) is headed by a Chief Vigilance Officer (CVO), who is also a Scientist 'G' of the rank of a Joint Secretary in the Central Government. He is supported by a Deputy Secretary, Section Officer and other secretarial staff.

Apart from handling vigilance related cases of the Department, its subordinate offices and aided institutions, it also deals with complaints, received from the CVC/CBI and other sources. It plays an active role in ensuring the prompt disposal of these complaints. The vigilance unit also handles vigilance disciplinary proceedings of appropriate rank. The vigilance side maintains a regular touch both with the CVC and the CBI.

During 2020, the Vigilance Unit dealt with the following number of complaints:

Source	Opening Balance	Recd. During the year	Total	Disposed	Balance
CVC	25	22	47	20	27
Others	54	82	136	90	46

The Vigilance unit also consolidates reports/returns received from the subordinate offices and aided institutions on vigilance matters and furnishes the reports (monthly, quarterly and annual basis) to various organizations, like Central Vigilance Commission, Central Bureau of Investigation and Department of Personnel and Training. The Department also maintains Agreed List in consultation with CBI and List of Officers of Doubtful Integrity of Gazetted status.

Besides, the CVO maintains close liaison with all attached/ subordinate offices to ensure timely completion of various vigilance tasks. The CVO keeps a watch over all cases pending at different stages including the cases of its attached and subordinate offices to ensure a time bound disposal of such cases.

In accordance with the directives of the CVC to spread awareness about transparency, accountability and corruption free governance, Vigilance Awareness Week was observed in DST from 27th October to 2nd November 2020 in association with the Department of Scientific and Industrial Research (DSIR). During this occasion an Integrity Pledge was administered to employees of DST & DSIR by Secretary, DST. Events like Slogan writing and Quiz competition were organized for DST/ DSIR employees through a digital platform because of COVID. A new event named Video Clip contest was organized exclusively for the children of employees of DST/ DSIR to spread the message on combating corruption. Two online training sessions on preventive vigilance were also organized.



Fig: Vigilance Awareness Week, 2020

CVO, DST is also laying emphasis and focusing on preventive vigilance as a measure to prevent reoccurrence of vigilance cases.

AUDIT OBSERVATION

Detailed position of Action Taken Notes (ATNs) to be included in the Annual Report for the year 2020-21 as per the table given below:

Sl. No.	Year	No. of Paras / PA Reports on which ATNs have been submitted to PAC after vetting by Audit	Details of the Paras/PA reports on which ATNs are pending.		
			No. of ATNs not sent by the Ministry even for the first time.	No. of ATNs sent but returned with observations and Audit is awaiting their resubmission by the Ministry	No. of ATNs which have been finally v e t t e d by audit but have not been submitted by the Ministry to PAC
1	6 of 2020- Compliance Audit Observations Union Government (Civil) for the period ended March, 2018.	----	1(14.1)	Nil	Nil

Annexure-II

Summary of important Audit Observations:

Report No. 6 of 2020 – Union Government (Civil) – Compliance Audit Observations – For the period ended March 2018

Department of Science and Technology

The Technology Development Board did not properly manage the financial assistance extended by it. This resulted in default in repayment of loan and interest amounting to ₹ 66.05 crore in seven selected projects.

(Paragraph No. 14.1)

संघ सरकार (सिविल) अनुपालनलेखापरीक्षा अभ्युक्तियाँ 2020 की प्रतिवेदन संख्या 6 - समाप्त वर्ष मार्च 2018

विज्ञान एवं प्रौद्योगिकी विभाग

प्रौद्योगिकी विकास बोर्ड ने इसके द्वारा दी गई वित्तीय सहायता का ठीक से प्रबंधन नहीं किया। इसके फलस्वरूप सात चयनित परियोजनाओं में ₹66.05 करोड़ के ऋण और ब्याज के पुनर्भुगतान में चूक हुई।

(पैराग्राफ नंबर 14.1)

BUDGET

DEPARTMENT OF SCIENCE AND TECHNOLOGY Summary of Financial Requirements

Sl. No	Head of Development Projects/ Programmes/Schemes	(Rs. in crore)			
		Actual 2019-20	BE 2020-21	RE 2020-21	BE 2021-22
1	Secretariat	110.91	141.96	136.61	123.40
2	Survey of India	434.42	453.42	449.01	533.60
3	NATMO	22.54	42.25	39.68	46.90
4	Autonomous Institutions and Professional Bodies	1217.70	1357.00	1375.00	1488.00
5	Science and Engineering Research Board	956.57	1000.00	742.00	900.00
6	Science and Technology Institutional and Human Capacity Building	1084.30	1169.50	918.35	1101.80
7	Research and Development	584.10	718.00	402.50	593.94
8	Innovation, Technology Development and Deployment	811.79	1050.65	656.30	951.95
9	National Mission on Interdisciplinary Cyber Physical Systems	122.79	270.85	270.85	270.00
10	Technology Development Board	98.00	100.00	10.00	50.00
11	Science Counsellors Abroad	9.91	10.00	11.80	12.00
Total- DST		5453.03	6313.63	5012.10	6071.59

11. ABBREVIATION

ABBR	Anaerobic Biphased Baffled Reactor
ABCD	Artificial Breathing Capability Device
AEEE	Alliance for an Energy Efficient Economy
AFEC	Agriculture, Food and Environmental Challenges
AICTE	All India Council for Technical Education
AISRF	Australia India Strategic Research Fund
AISTDF	ASEAN-India S&T Development Fund
AIT	Academia-Industry Training
AMRUT	Atal Mission For Rejuvenation And Urban Transformation
AMT	Advanced Manufacturing Technologies
APSCST	Arunachal Pradesh State Council for Science & Technology)
ARCI	Advanced Research Centre for Powder Metallurgy and New Materials
ARI	Agharkar Research Institute
ARIES	Aryabhata Research Institute of Observational Sciences
ARSAC	Assam Remote Sensing Application Centre
ASEAN	Association of Southeast Asian Nations
ASIC	Application Specific Integrated Circuit
ASTEC	Assam Science Technology & Environment Council
AUSC	Advanced Ultra Super Critical
AWSAR	Augmenting Writing Skills for Articulating Research
BBMP	Bruhat Bengaluru Mahanagara Palike
BCST	Bihar Council on Science & Technology
BDTD	Biomedical Device and Technology Development Program
BID	Biomedical Instruments and Devices
BIMSTEC	Bay of Bengal Initiative for Multi Sectoral Technical & Economic Cooperation
BRICS	Brazil, Russia, India, China, and South Africa
BSIP	Birbal Sahni Institute of Palaeosciences
CAWACH	Centre for Augmenting WAr on Covid 19 Health Crisis
CBM	Compressed Baryonic Matter
CCP	The Climate Change Programme
CeNS	Centre for Nano and Soft Matter Sciences
CERI	Clean Energy Research Initiative
CHORD	Centre for Human and organizational Research Development
CI	Critical Infrastructure
CII	Confederation of India Industry
CMERI	Central Mechanical Engineering Research Institute
CMS	Compact Muon Solenoid
CoE	Centre of Excellence
CORS	Continuously Operating Reference Stations

CORS	Continuously Operating Reference Stations
CPR	Centres for Policy Research
CPSRI	Cyber Physical Systems Research Initiatives
CSIR	Council of Scientific & Industrial Research
CSRE	Centre of Studies in Resources Engineering
CSRI	Cyber Security Research Initiatives
CSRP	Collaborative Scientific Research Programme
CURIE	Consolidation of University Research for Innovation & Excellence
CVO	Chief Vigilance Officer
CWC	Central Water Commission
DA	Development Alternatives
DAE	Department of Atomic Energy
DBT	Department of Biotechnology
DCLC	Direct Contact Liquid System
DDP	Device Development Program
DEM	Digital Elevation Model
DL	Deep Learning
DPMS	District Planning Map Series
DRDO	Defence Research and Development Organisation
DRL	Deep reinforcement
DSIR	Department of Scientific and Industrial Research
DSM	Defence Series Maps
DSRI	Data Science Research Initiatives
EDARI	Epidemiology Data Analytics Research Initiative
EIR	Entrepreneur In Residence
EIT&AI	Engineering & IT Solutions and Artificial Intelligence
ER&WWM	Energy and Water & Waste Management
EU	European Union
EWS	Early Warning System
FAIR	Facility for Antiproton and Ion Research
FASIE	Foundation for Assistance to Small Innovative Enterprises
FCDO	Foreign, Commonwealth & Development Office
FDP	Faculty Development Program
FFT	Frontier and Futuristic Technologies Division
FIST	Fund for Improvement of S & T Infrastructure in Universities and Higher Educational Institutions
FOCAL	Forward Calorimeter
G2C	Government to citizen
G2G	Government to Government
GATI	Gender Advancement for Transforming Institutions
GCPs	Ground Control Points

GDP	Gross domestic product
GEM	Gaseous Electron Multiplier
GERD	Gross Expenditure on Research & Development
GI	Geographical Indication
GIS	Geographical Information System
GITA	Global Innovation & Technology Alliance
GLP	Good Laboratory Practice
GOAT	Goa- Atlantic cooperation programme
GSDP	Green Skill Development Programme
GUJCOST	Gujarat Council on Science & Technology
HCN	Health Care and Nutrition
HGCAL	High Granularity Calorimeter
HICAB	Human and Institutional Capacity Building Programme
HPC	High Performance Computing
HR&IAG	Human Resources and International Advisory Group
HRNTDB	High Resolution National Topographical Data Base
HRSI	High Resolution Satellite Imagery
HTSTR	High Temperature Spin Test Rig
IACS	Indian Association for the Cultivation of Science
IARDP	Industry Academia Research & Development Programme
IASc	Indian Academy of Sciences
IASST	Institute of Advanced Study in Science and Technology
ICAR	Indian Council of Agricultural Research
ICD	International Cooperation Division
ICMR	Indian Council of Medical Research
ICONSAT	International Conference in Nano Science & Technology
ICPS	Inductively Coupled Plasma
ICTP	International Centre for Theoretical Physics
IFCPAR	Indo-French Centre for Promotion of Advanced Research
IGSTC	Indo-German Science & Technology Centre
IHDSRI	Indian Heritage in Digital Space Research Initiative
IHR	Indian Himalayan Region
IIA	Indian Institute of Astrophysics
IICDC	The India Innovation Challenge Design Contest
IIG	Indian Institute of Geomagnetism
IIGP	India Innovation Growth Program
IIHS	Indian Institute for Human Settlements
IIJRC	Indian Israeli Joint Research Cooperation Programme
IISF	India International Science Festival
IISM	Indian Institute of Surveying & Mapping
IMC	Index Monitoring Cell

IMPA	Institute for Pure and Applied Mathematics
INAE	Indian National Academy of Engineering
INSA	Indian National Science Academy
INSPIRE	Innovation in Science Pursuit for Inspired Research
INST	Institute of Nano Science and Technology
IoTTRI	Internet of Things Research Initiatives
IPR	Intellectual Property Rights
IRFB	Iron electrolyte based Redox flow Battery
IRIS	Initiative for Research & Innovation in STEM
ISARI	Imaging Spectroscopy & Applications Research Initiative
ISCA	Indian Science Congress Association
ISJRP	Indo-Swiss Joint Research Program
ISRF	India Science & Research Fellowship
ISRF	India Science & Research Fellowship
i-STED	Innovation, Science and Technology led Entrepreneurship Development
ITOFF	TMT Optics Fabrication Facility
IUSSTF	Indo-US Science and Technology Forum
JCERDC	Joint Clean Energy Research and Development Centre
JNCASR	Jawaharlal Nehru Centre for Advanced Scientific Research
JNV	Jawahar NavodayaVidyalayas
JVCEC	Joint Virtual Clean Energy Centre
KIRAN	Knowledge Involvement in Research Advancement through Nurturing
KSCST	Karnataka State Council for Science and Technology
KSNDMC	Karnataka State National Disaster Monitoring Centre
LHC	Large Hadron Collider
LMS	Learning Management System
MACS	Maharashtra Association for the Cultivation of Science
MEITY	Ministry of Electronics and Information Technology
MNRE	Ministry of New and Renewable Energy
MoEFCC	Ministry of Environment, Forest and Climate Change
MoES	Ministry of Earth Science
MPCST	Madhya Pradesh Council Of Science & Technology
NAPCC	National Action on Climate Change
NATAG	Nano Applications and Technology Advisory Group
NATMO	National Atlas and Thematic Mapping Organisation
NCG	National Centre for Geodesy
NCSTC	National Council of Science and Technology Communication
NDMP	National Disaster Management Plan
NDR	National Data Registry
NECTAR	North East Centre for Technology Application and Reach
NGCMA	National Good Laboratory Practice Compliance Monitoring Authority

NGP	National Geospatial Programme
NHHID	National Hub for Healthcare instrumentation Development
NHP	National Hydrology Project
NIDHI	National Initiative for Developing and Harnessing Innovations
NIF	National Innovation Foundation
NIGST	National Institute of Geoinformatics Science & Technology
NKN	National Knowledge Network
NMA	National Mapping Agency
NMC	Nano Mission Council
NMCG	National Mission for Clean Ganga
NMD	National Mathematics Day
NM-ICPS	National Mission on Interdisciplinary Cyber Physical System
NMP	National Map Policy
NM-QTA	National Mission on Quantum Technologies and Applications
NMR	Nuclear Magnetic Resonance
NMSHE	National Mission for Sustaining the Himalayan Ecosystem
NMSKCC	National Mission on Strategic Knowledge for Climate Change
NNetRA	Nano Electronics Networking and Research Applications
NRDMS	Natural Resources Data Management System
NSAG	Nano Science Advisory Group
NSD	National Science Day
NSM	National Supercomputing Mission
NSTEDB	National Science and Technology Entrepreneurship Development Board
NSTMIS	National Science & Technology Management Information System
NVS	Navodaya Vidyalaya Samiti
OCED	Organization for Economic Cooperation and Development
OIC	Open Innovation Challenge
ORC	Opportunity for Research Careers
PARVATI	Planning of Addition of Renewable and Electric Vehicles and its Integration
PCPM	Policy, Coordination and Programme Management
PFP	Patent Facilitation Programme
PFP	Policy Fellowship Programme
PGIMER	Postgraduate Institute of Medical Education and Research
PIC	Patent Information Centre
PMC	Project Monitoring Committee
POWER	Promoting Opportunities for Women in Exploratory Research
PPP	Public Private Partnership
PRABHASS	Pravasi Bharatiya Academic and Scientific Sampark
PRAYAS	PROMotion and Acceleration of Young and Aspiring Technology Entrepreneurs
PRP	Policy Research Programme
PURSE	Promotion of University Research and Scientific Excellence

QuSTRI	Quantum Science & Technology Research Initiative
RDC	Rotary Drum Composting
RETC	Renewable Energy Test Centre
RPC	Resistive Plate Chamber
RRI	Raman Research Institute
RTF-DCS	Research Training Fellowship for Developing Countries Scientists
RUSA	Rashtriya Uchattar Siksha Abhiyan
SAIF	Sophisticated Analytical Instrument Facilities
SATHI	Social Awareness Through Human Involvement
SATHI	Sophisticated Analytical & Technical Help Institutes
SCCC	State Climate Change Centres
SCO	Shanghai Cooperation Organisation
SCSP	Special Component Plan for Schedule Castes
SCTIMST	Sree Chitra Tirunal Institute for Medical Sciences and Technology
SDG	Sustainable Development Goals
SDRR	Spatial Disaster Risk Reduction
SEED	Science for Equity for Empowerment and Development
SERB	Science & Engineering Research Board
SERB	Science and Engineering Research Board
SERI	State Secretariat for Education Research and Innovation
SGIA	Smart Grids Innovation Accelerator
SHE	Scholarship for Higher Education
SHRI	Science and Heritage Research Initiative
SINE	Society for Innovation & Entrepreneurship
SOI	Survey of India
SPRERI	Sardar Patel Renewable Energy Research Institute
SRIMAN	Scientific Research Infrastructure Sharing Maintenance and Networks
SSA	Segment Support Assembly
SSR	Scientific Social Responsibility
SSTMC	State S&T Ministers Conclave
SSTP	State Science & Technology Programme
STEM	Science Technology Engineering and Mathematics
STIEP	Science, Technology, Innovation Entrepreneurship Partnership
STIP	Science, Technology, and Innovation Policy
SYST	Scheme for Young Scientist and Technologists
TAP-RISE	Technology Acceleration Platform for Rural Innovation and Social Entrepreneurship
TARA	Technological Advancement For Rural Area
TARE	Teachers Associateship for Research excellence
TBI	Technology Business Incubator
TCAD	Technology Computer-Aided Design
TDB	Technology Development Board

TDP	Technology Development Programmes
TEC	Technology Enabling Centres
TEDP	Technology Entrepreneurship Development Program
TF	Task Forces
TFAR	Technology Fusion & Applications Research
TIASN	Technological Interventions for Addressing Societal Needs
TIDE	Technology Informatics Design Endeavour
TIFAC	Technology Information Forecasting and Assessment Council
TIFAC	Technology Information Forecasting and Assessment Council
TIH	Technology Innovation Hubs
TIME-LEARN	Technology Intervention for Mountain Ecosystem-Livelihood Enhancement through Action, Research & Networking
TMIR	Technology Mission for Indian Railways
TMT	Thirty Meter Telescope
TORCH	Toxoplasmosis, Rubella, Cytomegalovirus and Herpes simplex
TRC	Technical Resource Centre
TRCs	Technical Research Centres
TRG	Telemetric Rain Gauges
TSP	Tribal Area Sub-Plan
TWSA	Terrestrial Water Storage Anomaly
UC	University Challenge
UCOST	Uttarakhand State Council for Science and Technology
UIS	UNESCO Institutes of Statistics
UKIERI	UK India Education & Research Initiative
UNIDO	United Nations Industrial Development Organization
USISTEF	United States-India Science & Technology Endowment Fund
VAIBHAV	Vaishwik Bharatiya Vaigyanik
WAQM	River Water and Air Quality Monitoring
WEDP	Women Entrepreneurship Development Program
WEE	Women Entrepreneurship and Empowerment
WFOS	Wide Field Optical Spectrograph
WFS	Web Feature Service
WICTRE	Water Innovation Centre Technology Research and Education
WIHG	Wadia Institute of Himalayan Geology
WISTEMM	Women in STEMM
WLS	Water Level Sensors
WMS	Web Map Service
WMT	Waste Management Technologies
WOS	Women Scientists Scheme
WTI	Water Technology Initiative
YASH	Year of Awareness on Science & Health



Department of Science & Technology
 Ministry of Science & Technology
 Technology Bhawan, New Mehrauli Road
 New Delhi - 110016, INDIA